

**SOKKIA**

**FX series**

**FX-101**

**FX-102**

**FX-103**

**FX-105**

**FX-107**

**Functional X-ellence Station**

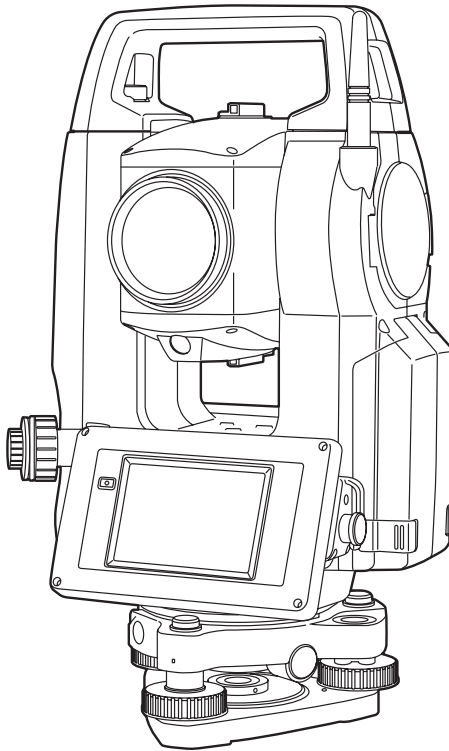

Class 3R Laser Product

**OPERATOR'S MANUAL**

21404 99020



**Li-ion**

CONTAINS Li-ion BATTERY.  
MUST BE RECYCLED OR DISPOSED OF PROPERLY.

**JSIMA**

This is the mark of the Japan Surveying  
Instruments Manufacturers Association.

**SOKKIA**

**FX series**

**FX-101**

**FX-102**

**FX-103**

**FX-105**

**FX-107**

**Functional X-ellence Station**

Class 3R Laser Product

**OPERATOR'S MANUAL**

- Thank you for selecting the FX-101/102/103/105/107.
- Please read this Operator's manual carefully, before using this product.
- FX has a function to output data to a connected host computer. Command operations from a host computer can also be performed. For details, refer to "Communication manual" and ask your local dealer.
- The specifications and general appearance of the instrument may be altered at any time and may differ from those appearing in brochures and this manual.
- The content of this manual may be altered at any time.
- Some of the diagrams shown in this manual may be simplified for easier understanding.

# HOW TO READ THIS MANUAL

## Symbols

---

The following conventions are used in this manual.



: Indicates precautions and important items which should be read before operations.



: Indicates the chapter title to refer to for additional information.



: Indicates supplementary explanation.



: Indicates an explanation for a particular term or operation.

[Softkey] etc. : Indicates softkeys on the display and window dialog buttons.

{Key} etc. : Indicates keys on the operation panel.

<Screen title> etc.: Indicates screen titles.

## Notes regarding manual style

---

- Except where stated, "FX" means FX-101/102/103/105/107 in this manual.
- The FX Series is available in "standard", "High Temperature", and "Low Temperature" models. Users with a "Low Temperature Model" should read the additional precautions specific to use under low temperatures.
- **Low Temperature Model**
- Low Temperature Models display the seal shown at right.



- Do not remove the Low Temperature Model seal from the instrument. This seal is used for model recognition by our engineers during maintenance.

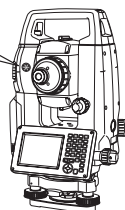

- Screens and illustrations appearing in this manual are of FX-103 (with *Bluetooth* module and display on face 1 only). Face 2 display is available as standard or as a factory option depending on the country of purchase.
- Location of softkeys in screens used in procedures is based on the factory setting. It is possible to change the allocation of softkeys.  
     Softkey allocation: "20.6 Allocating Key Functions"
- Learn basic operations in "4. PRODUCT OUTLINE" and "5. BASIC OPERATION" before you read each measurement procedure. For selecting options and inputting figures, see "5.1 Basic Key Operation".
- Measurement procedures are based on continuous measurement. Some information about procedures when other measurement options are selected can be found in "Note" (*Note*).

- KODAK is a registered trademark of Eastman Kodak Company.
- *Bluetooth*<sup>®</sup> is a registered trademark of Bluetooth SIG, Inc.
- Windows and Windows CE are registered trademarks of Microsoft Corporation.
- All other company and product names featured in this manual are trademarks or registered trademarks of each respective organization.

# CONTENTS

1. PRECAUTIONS FOR SAFE OPERATION .....	1
2. PRECAUTIONS .....	4
3. LASER SAFETY INFORMATION .....	8
4. PRODUCT OUTLINE.....	10
4.1 Parts of the Instrument .....	10
4.2 Mode Structure .....	13
4.3 Bluetooth Wireless Technology .....	14
5. BASIC OPERATION .....	16
5.1 Basic Key Operation .....	16
5.2 Display Functions .....	20
5.3 Disk Capacity .....	28
5.4 Inputting Characters using the Input Panel .....	29
6. INSERTING USB MEMORY .....	30
7. USING THE BATTERY .....	31
7.1 Battery Charging .....	31
7.2 Installing/Removing the Battery .....	32
8. SETTING UP THE INSTRUMENT.....	34
8.1 Centering .....	34
8.2 Levelling .....	36
9. POWER ON/OFF .....	38
9.1 Resolving Software Issues .....	39
9.2 Configuring the Touch Panel .....	39
10. CONNECTING TO EXTERNAL DEVICES .....	41
10.1 Wireless Communication using Bluetooth Technology .....	41
10.2 Communication between the FX and Companion Device .....	45
10.3 Connecting to USB devices .....	46
10.4 Connection via RS232C cable .....	49
11. FOCUSING AND TARGET SIGHTING .....	50
12. ANGLE MEASUREMENT .....	51
12.1 Measuring the Horizontal Angle between Two Points (Horizontal Angle 0°) .....	51
12.2 Setting the Horizontal Angle to a Required Value (Horizontal Angle Hold) .....	52
12.3 Angle measurement and Outputting the Data .....	53

---

13. DISTANCE MEASUREMENT .....	54
13.1 Returned Signal Checking .....	54
13.2 Distance and Angle Measurement .....	56
13.3 Distance Measurement and Outputting the Data .....	57
13.4 REM Measurement .....	58
14. COORDINATE MEASUREMENT .....	60
14.1 Entering Instrument Station Data .....	60
14.2 Azimuth Angle Setting .....	61
14.3 3-D Coordinate Measurement .....	64
15. RESECTION MEASUREMENT .....	66
15.1 Coordinate Resection Measurement .....	67
15.2 Height Resection Measurement .....	71
16. SETTING-OUT MEASUREMENT .....	76
16.1 Using the Guide Light .....	76
16.2 Distance Setting-out Measurement .....	77
16.3 Coordinates Setting-out Measurement .....	82
16.4 REM Setting-out Measurement .....	85
17. OFFSET MEASUREMENT .....	88
17.1 Single-distance Offset Measurement .....	88
17.2 Angle Offset Measurement .....	91
17.3 Two-distance Offset Measurement .....	93
18. MISSING LINE MEASUREMENT .....	96
18.1 Measuring the Distance between 2 or more Points .....	96
18.2 Changing the Starting Point .....	98
19. SURFACE AREA CALCULATION.....	100
20. CHANGING THE SETTINGS .....	104
20.1 Observation Conditions .....	104
20.2 Instrument Configuration .....	107
20.3 EDM Settings .....	109
20.4 Allocating User-defined Tabs .....	113
20.5 Customizing Screen Controls .....	115
20.6 Allocating Key Functions .....	117
20.7 Changing Status Bar Icons .....	120
20.8 Units .....	122
20.9 Changing Password .....	123
20.10 Restoring Default Settings .....	124

---

20.11 Date and Time .....	124
21. WARNING AND ERROR MESSAGES .....	125
22. CHECKS AND ADJUSTMENTS .....	129
22.1 Circular Level .....	129
22.2 Tilt Sensor .....	130
22.3 Collimation .....	133
22.4 Reticle .....	134
22.5 Optical Plummet .....	136
22.6 Additive Distance Constant .....	137
22.7 Laser Plummet (Option) .....	139
23. POWER SUPPLY SYSTEM .....	142
24. TARGET SYSTEM.....	143
25. OPTIONAL ACCESSORIES .....	145
26. SPECIFICATIONS .....	147
27. EXPLANATIONS .....	152
27.1 Manually Indexing the Vertical Circle by Face Left, Face Right Measurement .....	152
28. REGULATIONS .....	153
29. INDEX .....	158





# 1. PRECAUTIONS FOR SAFE OPERATION



For the safe use of the product and prevention of injury to operators and other persons as well as prevention of property damage, items which should be observed are indicated by an exclamation point within a triangle used with WARNING and CAUTION statements in this operator's manual.

The definitions of the indications are listed below. Be sure you understand them before reading the manual's main text.

## Definition of Indication

---







	<b>WARNING</b>	Ignoring this indication and making an operation error could possibly result in death or serious injury to the operator.
	<b>CAUTION</b>	Ignoring this indication and making an operation error could possibly result in personal injury or property damage.

-  This symbol indicates items for which caution (hazard warnings inclusive) is urged. Specific details are printed in or near the symbol.
-  This symbol indicates items which are prohibited. Specific details are printed in or near the symbol.
-  This symbol indicates items which must always be performed. Specific details are printed in or near the symbol.

## General

---

### **Warning**





-  Do not use the unit in areas exposed to high amounts of dust or ash, in areas where there is inadequate ventilation, or near combustible materials. An explosion could occur.
-  Do not perform disassembly or rebuilding. Fire, electric shock, burns, or hazardous radiation exposure could result.
-  Never look at the sun through the telescope. Loss of eyesight could result.
-  Do not look at reflected sunlight from a prism or other reflecting object through the telescope. Loss of eyesight could result.
-  Direct viewing of the sun using the telescope during sun observation will cause loss of eyesight. Use a solar filter (option), such as that in " ", for sun observation.
-  When securing the instrument in the carrying case make sure that all catches, including the side catches, are closed. Failure to do so could result in the instrument falling out while being carried, causing injury.

### **Caution**

-  Do not use the carrying case as a footstool. The case is slippery and unstable so a person could slip and fall off it.

## 1. PRECAUTIONS FOR SAFE OPERATION













---

-  Do not place the instrument in a case with a damaged catch, belt or handle. The case or instrument could be dropped and cause injury.
-  Do not wield or throw the plumb bob. A person could be injured if struck.
-  Secure handle to main unit with handle locks. Failure to properly secure the handle could result in the unit falling off while being carried, causing injury.
-  Tighten the adjustment tribrach clamp securely. Failure to properly secure the clamp could result in the tribrach falling off while being carried, causing injury.

### Power Supply

---





#### **Warning**

-  Do not short circuit. Heat or ignition could result.
  -  Do not place articles such as clothing on the battery charger while charging batteries. Sparks could be induced, leading to fire.
  -  Do not use voltage other than the specified power supply voltage. Fire or electrical shock could result.
  -  Do not use batteries other than those designated. An explosion could occur, or abnormal heat generated, leading to fire.
  -  Do not use damaged power cords, plugs or loose outlets. Fire or electric shock could result.
  -  Do not use power cords other than those designated. Fire could result.
  -  Use only the specified battery charger to recharge batteries. Other chargers may be of different voltage rating or polarity, causing sparking which could lead to fire or burns.
  -  Do not use the battery, charger or AC (power) cable for any other equipment or purpose. Fire or burns caused by ignition could result.
  -  Do not heat or throw batteries into fire. An explosion could occur, resulting in injury.
  -  To prevent shorting of the battery in storage, apply insulating tape or equivalent to the terminals. Otherwise shorting could occur resulting in fire or burns.
  -  Do not use batteries or the battery charger if wet. Resultant shorting could lead to fire or burns.
  -  Do not connect or disconnect power supply plugs with wet hands. Electric shock could result.
- #### **Caution**
-  Do not touch liquid leaking from batteries. Harmful chemicals could cause burns or blisters.

### Tripod

---





#### **Caution**

-  When mounting the instrument to the tripod, tighten the centering screw securely. Failure to tighten the screw properly could result in the instrument falling off the tripod, causing injury.
-  Tighten securely the leg fixing screws of the tripod on which the instrument is mounted. Failure to tighten the screws could result in the tripod collapsing, causing injury.
-  Do not carry the tripod with the tripod shoes pointed at other persons. A person could be injured if struck by the tripod shoes.
-  Keep hands and feet away from the tripod shoes when fixing the tripod in the ground. A hand or foot stab wound could result.
-  Tighten the leg fixing screws securely before carrying the tripod. Failure to tighten the screws could lead to the tripod legs extending, causing injury.

### Bluetooth wireless technology

---

#### **Warning**

-  Do not use within the vicinity of hospitals. Malfunction of medical equipment could result.
-  Use the instrument at a distance of at least 22 cm from anyone with a cardiac pacemaker. Otherwise, the pacemaker may be adversely affected by the electromagnetic waves produced and cease to operate as normal.
-  Do not use onboard aircraft. The aircraft instrumentation may malfunction as a result.
-  Do not use within the vicinity of automatic doors, fire alarms and other devices with automatic controls as the electromagnetic waves produced may adversely affect operation resulting in an accident.

### Use under low temperatures (Low Temperature Model only)

---

#### **Caution**

-  In temperatures around -30°C do not touch metal parts on the main unit, the accessories and the carrying case with bare hands. Exposed skin may stick to parts and cause burns and loss of skin.

# 2. PRECAUTIONS

## Telescope

---

- Aiming the telescope at the sun will cause internal damage to the instrument. Use the solar filter when observing the sun.  
☞ "25. Optional accessories"

## Tribrach Clamp and Handle

---

- When the instrument is shipped, the tribrach clamp is held firmly in place with a locking screw to prevent the instrument from shifting on the levelling base. Before using the instrument the first time, loosen this screw with a screwdriver. And before transporting it, tighten the locking screw to fasten the tribrach clamp in place so that it will not shift on the tribrach.
- The FX handle can be removed. When operating the FX with the handle attached, always make sure that the handle is securely fixed to the FX body with the handle locks.

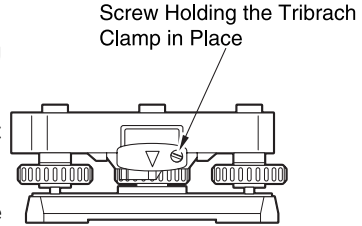

## Precautions concerning water and dust resistance

---

FX conforms to IP65 specifications for waterproofing and dust resistance when battery cover, connector cap and the external interface hatch are closed.

- Be sure to correctly attach the connector caps to protect the FX from moisture and dust particles when the connector is not in use.
- Make sure that moisture or dust particles do not come in contact with the terminal or connectors. Operating the instrument with moisture or dust on the terminal or connectors may cause damage to the instrument.
- Make sure that the inside of the carrying case and the instrument are dry before closing the case. If moisture is trapped inside the case, it may cause the instrument to rust.
- If there is a crack or deformation in the rubber packing for the battery cover or external interface hatch, stop using and replace the packing.
- To retain the waterproof property, it is recommended that you replace the rubber packing once every two years. To replace the packing, contact your local sales representative.
- Do not press the speaker hole using something with a pointed tip. Doing so will damage an internal waterproof sheet, resulting in a degraded waterproof property.

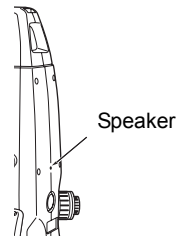

## The Lithium Battery

---

- The lithium battery is used to maintain the FX Calendar & Clock function. It can back up data for approximately 5 years of normal use and storage (Temperature = 20°, humidity = about 50%), but its lifetime may be shorter depending on circumstances.

### Vertical and horizontal clamps

---

- Always fully release the vertical/horizontal clamps when rotating the instrument or telescope. Rotating with clamp(s) partially applied may adversely affect accuracy.

### Backing up data

---

- Data should be backed up (transferred to an external device etc.) on a regular basis to prevent data loss.

### Use under low temperatures (Low Temperature Model only)

---

- Do not use force to scrape off frost from the lens or display unit screen. Frost is an abrasive material and may scratch the instrument.
- If ice or snow attaches itself to the unit, wipe it off with a soft cloth, or place the unit in a warm room until the ice melts, and then wipe off the meltwater. Operating the unit with ice or snow attached may cause operation errors to occur.
- Wipe off condensation with a soft cloth before using the instrument. Not doing so may cause operation errors to occur.
- The working duration of battery BDC70 will rapidly decline in cold temperatures. When using the instrument in temperatures around  $-30^{\circ}\text{C}$ , we recommend that you use external battery BDC60/61 (optional accessory) and dedicated cables EDC119. However, if you unavoidably must use battery BDC70 for measurements in temperatures around  $-30^{\circ}\text{C}$ , recharge the battery in a warm room and keep the battery in a warm place such as your pocket until it is used. (Working duration of battery will change with environmental conditions.)
- The lens cap and lens hood may become difficult to attach in low temperatures. Keep them in a warm place such as a pocket until attached.
- If the unit is carried between locations that have extreme temperature differences, protect the unit from rapid temperature change by placing it in the carrying case.
- Please use the tribrach supplied as standard. If a different tribrach is used, angle measurement errors may occur.

### Other precautions

---

- Never place the instrument directly on the ground. Sand or dust may cause damage to the screw holes or the centering screw on the base plate.
- Do not perform vertical rotation of the telescope when using the lens hood, diagonal eyepiece, or solar filter. Such accessories may strike the FX causing damage.
- Protect the instrument from heavy shocks or vibration.
- Protect the instrument from rain or drizzle with an umbrella or waterproof cover.
- Never carry the instrument on the tripod to another site.
- Turn the power off before removing the battery.
- Remove the battery before placing the FX in its case.
- Make sure that the instrument and the protective lining of the carrying case are dry before closing the case. The case is hermetically sealed and if moisture is trapped inside, the instrument could rust.
- Consult your local dealer before using the instrument under special conditions such as long periods of continuous use or high levels of humidity. In general, special conditions are treated as being outside the scope of the product warranty.

## 2. PRECAUTIONS

---

### Exporting this product

---

- This product is equipped with the parts/units, and contains software/technology, which are subject to the EAR (Export Administration Regulations). Depending on countries you wish to export or bring the product to, a US export license may be required. In such a case, it is your responsibility to obtain the license. The countries requiring the license as of January 2012 are shown below. Please consult the Export Administration Regulations as they are subject to change.

North Korea

Iran

Syria

Sudan

Cuba

URL for the EAR of the US: [http://www.access.gpo.gov/bis/ear/ear\\_data.html](http://www.access.gpo.gov/bis/ear/ear_data.html)

### Maintenance

---

- Wipe off moisture completely if the instrument gets wet during survey work.
- Always clean the instrument before returning it to the case. The lens requires special care. First, dust it off with the lens brush to remove tiny particles. Then, after providing a little condensation by breathing on the lens, wipe it with the wiping cloth.
- If the display is dirty, carefully wipe it with a soft, dry cloth. To clean other parts of the instrument or the carrying case, lightly moisten a soft cloth in a mild detergent solution. Wring out excess water until the cloth is slightly damp, then carefully wipe the surface of the unit. Do not use any alkaline cleaning solutions, alcohol, or any other organic solvents on the instrument or display.
  - ☞ For temporal de-activating the touch panel, see "5.2 Display Functions", "20. CHANGING THE SETTINGS"
- Store the instrument in a dry room where the temperature remains fairly constant.
- Check the tripod for loose fit and loose screws.
- If any trouble is found on the rotatable portion, screws or optical parts (e.g. lens), contact your local dealer.
- When the instrument is not used for a long time, check it at least once every 3 months.
  - ☞ "22. CHECKS AND ADJUSTMENTS"
- When removing the instrument from the carrying case, never pull it out by force. The empty carrying case should be closed to protect it from moisture.
- Check the instrument for proper adjustment periodically to maintain the instrument accuracy.

### Exceptions from responsibility

---

- The user of this product is expected to follow all operating instructions and make periodic checks (hardware only) of the product's performance.
- The manufacturer, or its representatives, assumes no responsibility for results of faulty or intentional usage or misuse including any direct, indirect, consequential damage, or loss of profits.
- The manufacturer, or its representatives, assumes no responsibility for consequential damage, or loss of profits due to any natural disaster, (earthquake, storms, floods etc.), fire, accident, or an act of a third party and/or usage under unusual conditions.
- The manufacturer, or its representatives, assumes no responsibility for any damage (change of data, loss of data, loss of profits, an interruption of business etc.) caused by use of the product or an unusable product.
- The manufacturer, or its representatives, assumes no responsibility for any damage, and loss of profits caused by usage different to that explained in the operator's manual.
- The manufacturer, or its representatives, assumes no responsibility for damage caused by incorrect operation, or action resulting from connecting to other products.

# 3. LASER SAFETY INFORMATION

FX is classified as the following class of Laser Product according to IEC Standard Publication 60825-1 Ed.2.0: 2007 and United States Government Code of Federal Regulation FDA CDRH 21CFR Part 1040.10 and 1040.11 (Complies with FDA performance standards for laser products except for deviations pursuant to Laser Notice No.50, dated June 24, 2007.)

- EDM device in objective lens: Class 3R Laser Product
- (When using prism or reflective sheet as target) Class 1 Laser Product
- Guide light: Class 1 LED product
- Laser plummet (option): Class 2 Laser Product

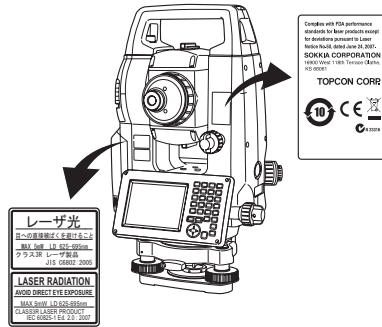
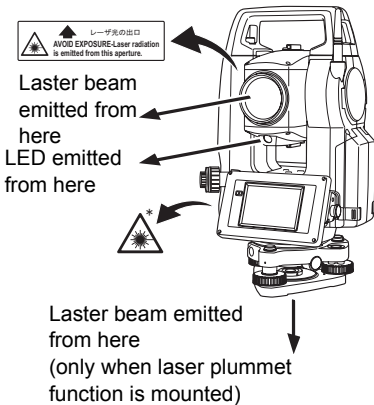

- EDM device is classified as Class 3R Laser Product when reflectorless measurement is selected. When the prism or reflective sheet is selected as target, the output is equivalent to the safer class 1.

## Warning

- Use of controls or adjustments or performance of procedures other than those specified herein may result in hazardous radiation exposure.
- Follow the safety instructions on the labels attached to the instrument as well as in this manual to ensure safe use of this laser and LED product.
- Never point the laser beam at another person. If the laser beam strikes skin or an eye, it could cause serious injury.
- Do not look directly into the laser beam source or guide light source. Doing so could cause permanent eye damage.
- Do not stare at the laser beam. Doing so could cause permanent eye damage.
- If an eye injury is caused by exposure to the laser beam, seek immediate medical attention from a licensed ophthalmologist.
- Never look at the laser beam through a telescope, binoculars or other optical instruments. Doing so could cause permanent eye damage.
- Sight the target so that the laser beam does not stray from them.



## **Caution**

- Perform checks at start of work and periodic checks and adjustments with the laser beam emitted under normal conditions.
- When the instrument is not being used, turn off the power and replace the lens cap.
- When disposing of the instrument, destroy the battery connector so that the laser beam cannot be emitted.
- Operate the instrument with due caution to avoid injuries that may be caused by the laser beam unintentionally striking a person in the eye. Avoid setting the instrument at heights at which the path of the laser beam may strike pedestrians or drivers at head height.
- Never point the laser beam at mirrors, windows or surfaces that are highly reflective. The reflected laser beam could cause serious injury.
- When using the laser-pointer function, be sure to turn OFF the output laser after distance measurement is completed. Even if distance measurement is canceled, the laser-pointer function is still operating and the laser beam continues to be emitted.
- Only those who have been received training as per the following items shall use this product.
  - Read the Operator's manual for usage procedures for this product.
  - Hazardous protection procedures (read this chapter).
  - Requisite protective gear (read this chapter).
  - Accident reporting procedures (stipulate procedures beforehand for transporting the injured and contacting physicians in case there are laser induced injuries).
- Persons working within the range of the laser beam are advised to wear eye protection which corresponds to the laser wavelength of the instrument being used
- Areas in which the lasers are used should be posted with laser warning notices.
- The LED beam is emitted when the guide light is set to ON and the power is turned ON. Before turning ON the power check that there are no persons in the LED beam path. Alternatively, always set the guide light to OFF when you have finished measurement.
  -  Guide light settings for setting-out: "16.1 Using the Guide Light"

# 4. PRODUCT OUTLINE

## 4.1 Parts of the Instrument

### Parts and functions of the instrument

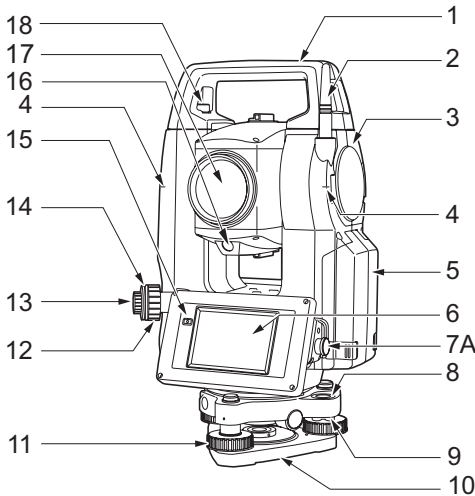

- 1 Handle
- 2 *Bluetooth* antenna
- 3 External interface hatch  
(USB port / Reset button)
- ☞ "10. CONNECTING TO EXTERNAL DEVICES"
- 4 ☐ Instrument height mark
- 5 Battery cover
- 6 Display unit
- 7A Serial connector
- 7B Serial / External power source connector
- 8 Circular level
- 9 Circular level adjusting screws
- 10 Base plate
- 11 Levelling foot screw
- 12 Optical plummet focussing ring
- 13 Optical plummet eyepiece
- 14 Optical plummet reticle cover
- 15 Luminance sensor
- 16 Guide light
- 17 Objective lens  
(Includes "☐ Laser-pointer function")

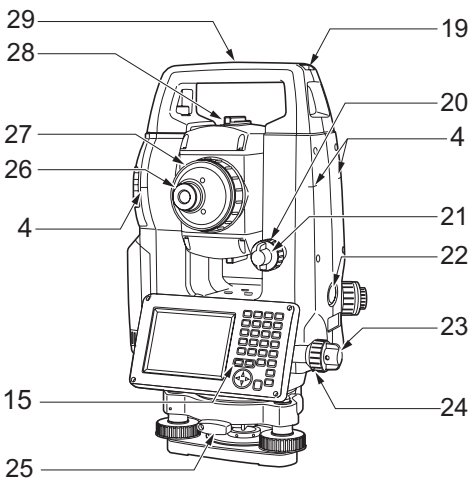

- 18 Handle locking screw
- 19 Tubular compass slot
- 20 Vertical fine motion screw
- 21 Vertical clamp
- 22 ☐ Trigger key
- 23 Horizontal clamp
- 24 Horizontal fine motion screw
- 25 Tribrach clamp
- 26 Telescope eyepiece screw
- 27 Telescope focussing ring
- 28 ☐ Sighting collimator
- 29 Instrument center mark

FX-101, 102 and low temperature models only





**Guide light**

Setting-out measurement etc. can be carried out effectively using the guide light. The guide light is composed of a light that is divided into green and red sections. A poleman can ascertain the present position by checking the guide light color.

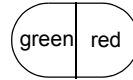
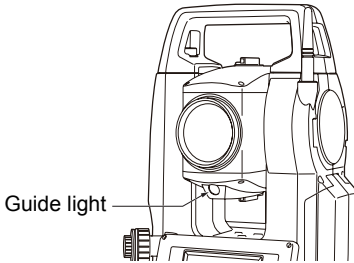

(When seen from the objective lens side while the instrument is in the Face 1 state)

Indication for positioning target during setting-out measurement

Light status	Meaning
Increased flashing speed	(From position of poleman) Move target toward FX
Decreased flashing speed	(From position of poleman) Move target away from FX
Fast flashing	Target is at correct distance
Red	(From position of poleman) Move target left
Green	(From position of poleman) Move target right
Red and Green	Target is at correct horizontal position

The guide light indicator is lit or flashes depending on the status of the guide light.

"16.1 Using the Guide Light"



**Sighting collimator**

Use sighting collimator to aim the FX in the direction of the measurement point.

Turn the instrument until the apex of the triangle in the sighting collimator is aligned with the target. A circle surrounds the triangle to make it easier to locate.



**Instrument height mark**

The height of the FX is 236mm (from tribrach dish to this mark). "Instrument height" is input when setting instrument station data and is the height from the measuring point (where FX is mounted) to this mark.



**Trigger key**

When the Trigger key is pressed FX carries out the operation indicated by the softkey in bold type on the screen. This allows the user to continue operation without having to return to the display to press softkeys.



**Laser-pointer function**

A target can be sighted with a red laser beam in dark locations without the use of the telescope.

## 4. PRODUCT OUTLINE

---

### **Bluetooth antenna (Models with Bluetooth module only)**

---

The *Bluetooth* antenna allows communication via *Bluetooth* wireless technology.

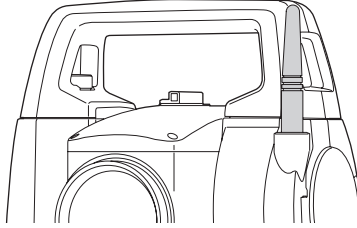

- Handle the antenna with care. The antenna may be damaged if struck during operation or while being stored in the carrying case.

### **Handle**

---

The carrying handle can be removed from the instrument. To remove it, loosen the handle rocking screw.

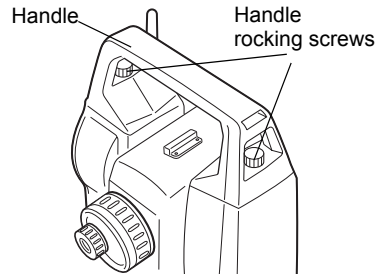

- To remove the handle, hold both sides of the handle and lift it straight above. If you hold the handle by one hand or incline it, the terminal attached on the handle may be damaged.

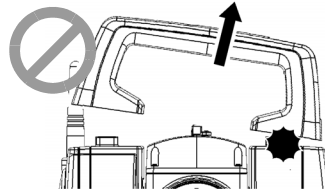
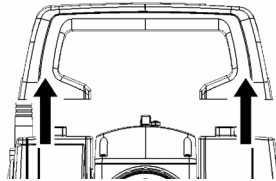

## 4.2 Mode Structure

The diagram below describes the different modes of the FX and key operations for navigating between them.

### •Basic mode

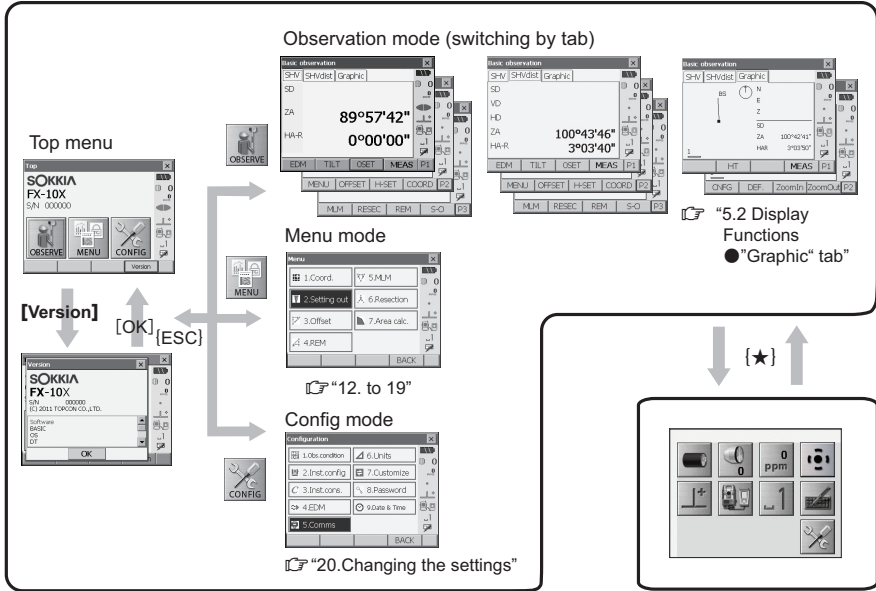

### •Program mode

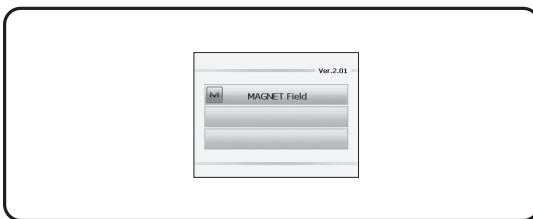

### •Star key mode

{★} "5.4 Star key mode"

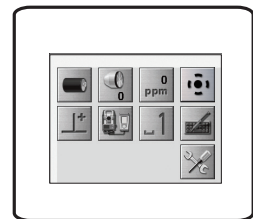

- Switching between modes is not possible during distance measurement.
- Do not switch between modes by **{PRG}** or not turn OFF the power during displaying the message "Executing program mode".

### 4.3 Bluetooth Wireless Technology



- *Bluetooth* communication is only possible with instruments incorporating the *Bluetooth* module.
- Use of this technology must be authorized according to telecommunications regulations of the country where the instrument is being used. Contact your local dealer in advance.  
☞ "28. REGULATIONS"
- TOPCON CORPORATION is not liable for the content of any transmission nor any content related thereto. When communicating important data, run tests beforehand to ascertain that communication is operating normally.
- Do not divulge the content of any transmission to any third party.

#### Radio interference when using *Bluetooth* technology

---

*Bluetooth* communication with the FX uses the 2.4 GHz frequency band. This is the same band used by the devices described below.

- Industrial, scientific, and medical (ISM) equipment such as microwaves and pacemakers.
- portable premises radio equipment (license required) used in factory production lines etc.
- portable specified low-power radio equipment (license-exempt)
- IEEE802.11b/IEEE802.11g standard wireless LAN devices

The above devices use the same frequency band as *Bluetooth* communications. As a result, using the FX within proximity to the above devices may result in interference causing communication failure or reduction of transmission speed.

Although a radio station license is not required for this instrument, bear in mind the following points when using *Bluetooth* technology for communication.

- Regarding portable premises radio equipment and portable specified low-power radio equipment:
  - Before starting transmission, check that operation will not take place within the vicinity of portable premises radio equipment or specified low-power radio equipment.
  - In the case that the instrument causes radio interference with portable premises radio equipment, terminate the connection immediately and take measures to prevent further interference (e.g. connect using an interface cable).
  - In the case that the instrument causes radio interference with portable specified low-power radio equipment, contact your local dealer.
- When using the FX in proximity to IEEE802.11b or IEEE802.11g standard wireless LAN devices, turn off all devices not being used.
  - Interference may result, causing transmission speed to slow or even disrupting the connection completely. Turn off all devices not being used.
- Do not use the FX in proximity to microwaves.
  - Microwave ovens can cause significant interference resulting in communication failure. Perform communication at a distance of 3m or more from microwave ovens.
- Refrain from using the FX in proximity to televisions and radios.

- Televisions and radios use a different frequency band to *Bluetooth* communications. However, even if the FX is used within proximity to the above equipment with no adverse effects with regard to *Bluetooth* communication, moving a *Bluetooth* compatible device (including the FX) closer to said equipment may result in electronic noise in sound or images, adversely affecting the performance of televisions and radios.

### Precautions regarding transmission

---

- For best results
  - The usable range becomes shorter when obstacles block the line of sight, or devices such as PDAs or computers are used. Wood, glass and plastic will not impede communication but the usable range becomes shorter. Moreover, wood, glass and plastic containing metal frames, plates, foil and other heat shielding elements as well as coatings containing metallic powders may adversely affect Bluetooth communication and concrete, reinforced concrete, and metal will render it impossible.
  - Use a vinyl or plastic cover to protect the instrument from rain and moisture. Metallic materials should not be used.
  - The direction of the *Bluetooth* antenna can have adverse effects upon usable range.
- Reduced range due to atmospheric conditions
  - The radio waves used by the FX may be absorbed or scattered by rain, fog, and moisture from the human body with the limit of usable range becoming lower as a result. Similarly, usable range may also shorten when performing communication in wooded areas. Moreover, as wireless devices lose signal strength when close to the ground, perform communication at as high a position as possible.

# 5. BASIC OPERATION

Learn basic key operations here before you read each measurement procedure.

## 5.1 Basic Key Operation

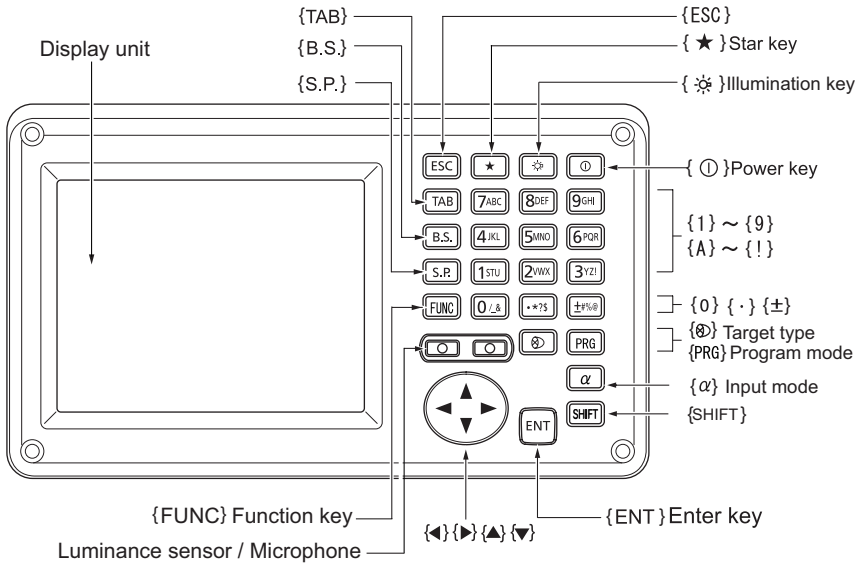

### ● Power ON/OFF

{⏻}	Power ON
{⏻} (Press and hold: About 1 second)	Power OFF

### ● Lighting up the reticle/keys and selecting screen backlight brightness

{☀}	Switches the screen/key light On/Off
	Switches the backlight brightness

☞ "20.2 Instrument Configuration"

### ● Switching to Program mode

{PRG}	Switches to program mode
-------	--------------------------



- Do not switch between modes by {PRG} or not turn OFF the power during displaying the message "Executing program mode".

### ● Switching target type

{⊕}	Switches between target types Prism/Sheet/N-prism(reflectorless)
-----	---------------------------------------------------------------------

☞ "20.3 EDM Settings"



- Changes can also be made by tapping the display with the stylus pen.

☞ "5.2 Display Functions"



- **Switching the page**

{FUNC}	Toggle between Observation mode screen pages
--------	----------------------------------------------

- **Inputting letters/figures**

{α}	Switch between numerals and alphabetic characters
{SHIFT} + {1} to {9}	In alphabetic characters mode, switch between lowercase characters and upper case characters each time
{SHIFT} (Press and hold)	In alphabetic characters mode, switch between lowercase characters and upper case characters
{α} + {SHIFT}	<Input Panel> is displayed
{0} to {9}	Input numeral or symbol printed above the key (during numeric input mode) Input alphabetic character in the order they are listed (in alphabetic input mode)
{.}	Input a decimal point (during numeric input mode)
{±}	Input a plus or minus sign (during numeric input mode)
{ESC}	Cancel the input data
{TAB}	Shift to the next item
{B.S.}	Delete a character on the left.
{S.P.}	Input a blank space (increments by 1 when setting the date and time)
{◀}/▶}	Move the cursor left/right during character input
{▲}/▼}	Move the cursor up/down during character input
{ENT}	Select/accept input word/value

- **Selecting options**

{▲}/▼}	Move the cursor/selection item up/down
{◀}/▶}	Move the cursor/selection item left/right or select other option
{TAB}	Shift to the next item
{S.P.}	Display other options
{ENT}	Select/accept the option

- **Selecting tabs**

{▲}/▼}	Move tab/cursor in tab up/down
{◀}/▶}	Display next tab at left/right

 Tabs: "5.2 Display Functions"

- **Switching the Laser-pointer/Guide light ON/OFF**

 (Press and hold)	To turn the laser-pointer/guide light ON/OFF, press and hold until a beep sounds.
------------------------------------------------------------------------------------------------------	-----------------------------------------------------------------------------------

**Note**

- Changes can also be made by tapping the display with the stylus pen.

 "5.2 Display Functions"

- **Others**

{ESC}	Return to previous screen
-------	---------------------------

## 5. BASIC OPERATION

---

### Example: Entering "computer" (lower case) as the name of a new device

---

1. Tap the input mode icon in the status bar (second from bottom) until "\_a" is displayed.



2. Press {7} three times. "c" is displayed.



3. Press {5} three times. "o" is displayed.



- Press **[▶]**.  
Press **{5}**. "m" is displayed.



- Continue to input letters. Press **{ENT}** to complete inputting.

### Example: selecting a reflector type

#### (Method 1)

- Select **[EDM]** in the first page of Observation mode or "EDM" in Config mode/Configuration mode.

● **Observation mode screen (P.22)**

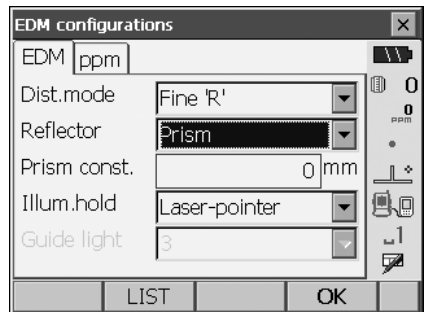

- Move to "Reflector" using **{▲}/ {▼}/ {TAB}**.
- Press **{SPACE}** to display a list of all options.

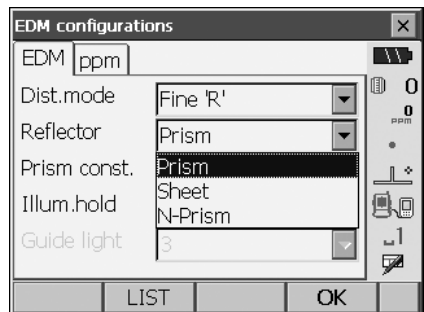

- Select an option using **{▲}/ {▼}**.
- Press **{ENT}** to confirm selection.

## 5. BASIC OPERATION

---

### (Method 2)

1. Select **[EDM]** in the first page of Measure mode or "EDM" in Config mode/Configuration mode.
2. Move to "Reflector" using **{▲}/ {▼}/ {TAB}**.
3. Switch between Prism, Sheet, and N-Prism using **{◀}/ {▶}**.
4. Press **{ENT}** to confirm selection.

## 5.2 Display Functions

Screens can be selected/operated using the keys on the keyboard or the touch panel. The touch panel can be operated using either the stylus pen provided or your fingers.

It is also possible to de-activate the touch panel temporarily.

 "20. CHANGING THE SETTINGS"



- Do not scratch the display or use any sharp implement other than the stylus pen to operate the touch panel.

### Using the stylus

---

The stylus pen can be used to select menus and buttons on the screen and operate the scroll bar. The touch panel supports "tap", "double tap", and "drag" operations.

Operation	Method
Tap	Lightly tap the display once. This operation is equivalent to the clicking of a mouse button when using a computer.
Double tap	Lightly tap the display twice on the same point. This operation is equivalent to the "double-click" for a computer mouse.
Drag	Lightly apply the point of the stylus pen to the display and move in the desired direction, maintaining contact between the stylus and display all the time.

## Temporarily de-activating the touch panel

The touch panel can be temporarily de-activated. This is especially useful when cleaning the display. To de-activate, tap  on the status bar. <Touch panel temporarily de-activated> is displayed.

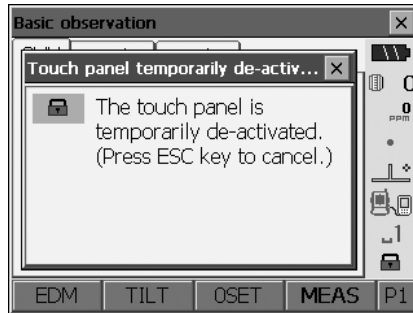

The touch panel cannot be operated while the above message is displayed. Press **{ESC}** to cancel the message and re-activate the touch panel.

- Touch panel icon

 "20.7 Changing Status Bar Icons"

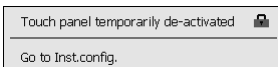

: Touch panel temporarily de-activated.



- This icon cannot be operated during distance measurement, or during data transmission.

Displaying and operating screens

- To close a screen, tap the cross in the top right corner, or press {ESC}.
- Tabs, softkey allocations, displayed tab items, and character sizes can all be changed in accordance with user preferences.

☞ "20. CHANGING THE SETTINGS"

● Top menu

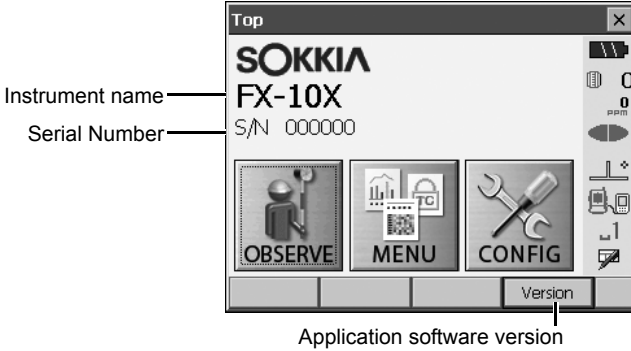

● Observation mode screen

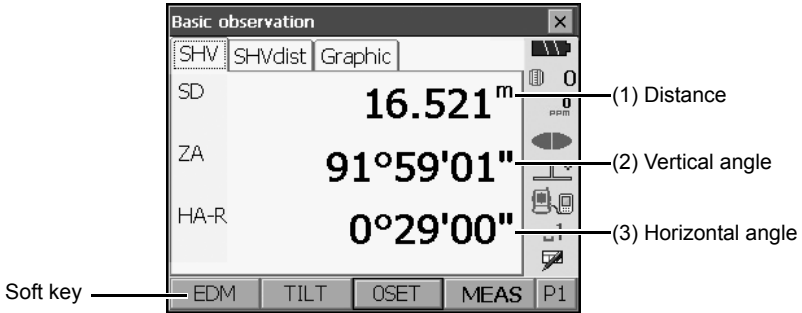

(1) Distance

Press [SHV] to switch between the "SHV" and "SHVdist" tabs. An "SHVdist" tab will be created when one does not exist.

☞ "20.1 Observation Conditions"

☞ "20.6 Allocating Key Functions"

(2) Vertical angle

The Vertical angle display can be switched between Zenith (Z=0°)/Horiz (H=0°)/Horiz (H=±90°). To switch vertical angle/slope in %, press [ZA/%] when allocated to the Observation mode screen. The capitalized letter in the softkey indicates the currently selected mode.

☞ "20.1 Observation Conditions"

(3) Horizontal angle

Press **[R/L]** when allocated to the Observation mode screen to switch the display status. The capitalized letter in the softkey indicates the currently selected mode.

HA-R : Horizontal angle right

HA-L : Horizontal angle left

"20.6 Allocating Key Functions"

● **Input screen/configuration screen**

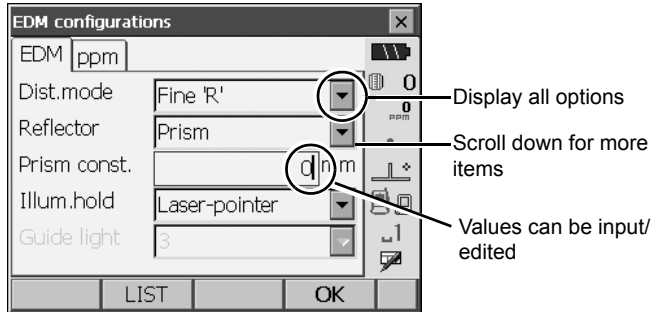

● **"Graphic" tab**

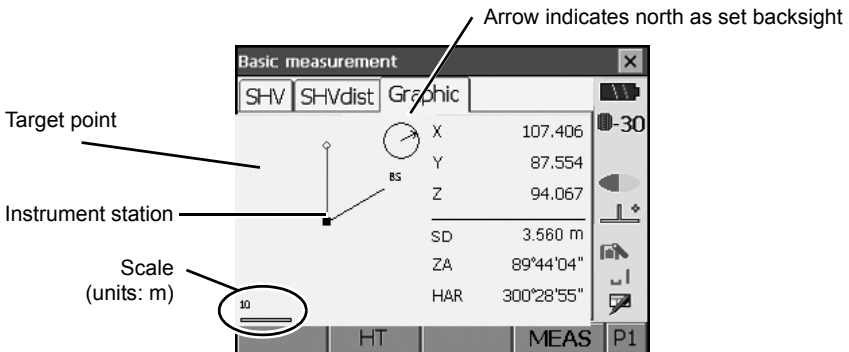

The "Graphic" tab display can be modified using the softkeys in the second page.

**[CNFG]:** In <Graphic configuration> the user can specify the orientation of the "graphic" tab display and which point, target or station, to set at the center of the display.

**[DEF.]:** Returns to the original orientation display.

**[ZoomIn]:** Zooms in.

**[ZoomOut]:** Zooms out.

## 5. BASIC OPERATION

### ● Selecting menus

To select a menu, tap the touch panel or press the relevant number key.

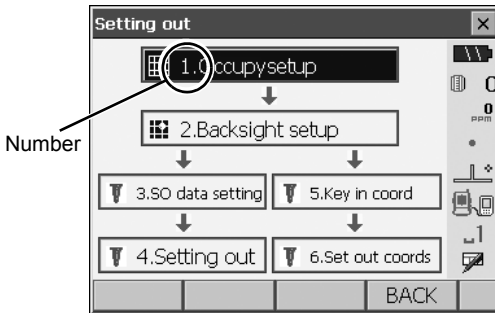

### ● Status bar

Indicates the current status of the instrument. Tapping icons (1) to (8) will switch between the relevant options for that item. Tapping and holding will display a list of all available options for that item and, in certain cases, a link to the configuration screen for that item.

Settings: "20. CHANGING THE SETTINGS"



- When the instrument is powered OFF while displaying a list of available options, resume function will be canceled. When power is back ON, the instrument will be reset.

"9. POWER ON/OFF D Resume function"

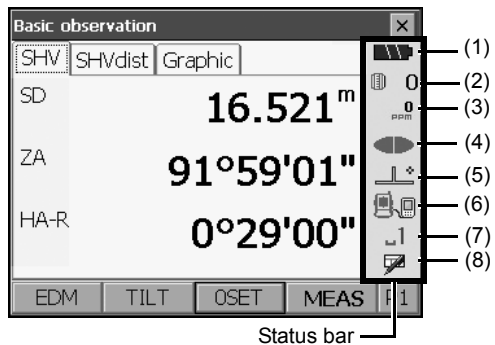

It is possible to re-arrange status bar icons.

"20.7 Changing Status Bar Icons"

#### (1) Remaining battery power

Remaining battery power indicator and configuration of auto-power function (BDC70/external battery BDC60/61, Temperature = 20°C, EDM on).

The remaining battery power displayed when distance measurement is in progress may differ to that displayed at other times.

: Level 3 Full power

: Level 2 Plenty of power remains

: Level 1 Half or less power remains

: Level 0 Little power remains. Prepare a replacement battery where available (Flashes red and black)



When using external battery



: Level 3 Full power



: Level 2 Plenty of power remains



: Level 1 Half or less power remains



Level 0 Little power remains. Prepare a replacement battery where available

"7. USING THE BATTERY"

(2) Target display

Selection of target type and configuration of prism constant.

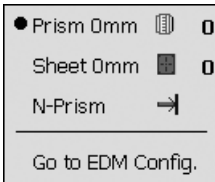

: Prism (0mm)

: Sheet (0mm)

: N-Prism

Target information can be edited/recorded in <Reflector setting>.

"20.3 EDM Settings"

(3) PPM setting

Configuration of EDM.

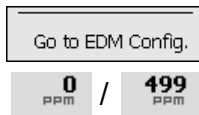

(4) Laser-pointer/guide light

Configuration of laser-pointer/guide light status.

Switching the laser-pointer/guide light ON/OFF: "5.1 Basic Key Operation"

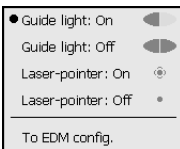

: Guide light ON

: Guide light OFF

: Laser-pointer ON

: Laser-pointer OFF







- The laser-pointer will be automatically switched OFF during distance measurement.

## 5. BASIC OPERATION

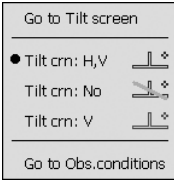
### (5) Tilt angle compensation

The vertical and horizontal angles are automatically compensated for small tilt errors using the FX's dual-axis tilt sensor. This icon displays the status of this function.



- Tilt cm: H,V  : Horizontal and vertical tilt angles compensated (blue)
- Tilt cm: No  : No compensation
- Tilt cm: V  : Only vertical tilt angle compensated (green)



### Note

-  is displayed when the instrument is out of level.

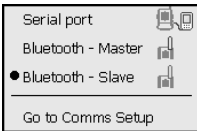

### (6) Communication status with external devices

Selection and configuration of communication status with external devices. This icon is not displayed in Program mode. *Bluetooth* settings can only be selected when using instruments incorporating the *Bluetooth* module.



- Serial port  : Connection via RS232C cable
- Bluetooth - Master  : Connection via *Bluetooth* wireless technology (FX set as "Master" device) (blue antenna)
- Bluetooth - Slave  : Connection via *Bluetooth* wireless technology (FX set as "Slave" device) (green antenna)

### Note

- When *Bluetooth* communication is selected (FX set as "Master" device) a connection can be initiated/canceled
- by tapping  / .

Connection status to external devices is displayed as follows.

#### i) Connection via *Bluetooth* wireless technology

When FX is set as the "Master" device the antenna mark is blue. When the FX is set as the "Slave" device the antenna mark is green.



: Connecting



: Canceling connection



: (Antenna is purple - moving)

FX set to "Master": Inquiring about other *Bluetooth* devices



: (Antenna is purple - stationary)

Communication settings in progress/Preparing for



communication (Instrument just powered ON or just switched to "Slave")



: Connection error (icon flashes green and red)

ii) : Connection via RS232C cable

**Note**

- An arrow (e.g.  / ) is displayed to indicate that data transmission is in progress. A red arrow indicates that data transmission has failed and data needs to be sent again.

(7) Input mode

Selection of input mode

_1	Inputting numbers and symbols
_a	Inputting lower case alphabetic characters
_A	Inputting upper case alphabetic characters

**Note**

- In alphabetic characters mode, lowercase characters and upper case characters can be switched each time by pressing **{SHIFT}** and **{1}** to **{9}** together.

(8) Input panel

 "5.4 Inputting Characters using the Input Panel"

● **Star key mode**

Press star key **[★]** to enter star key mode.  
Each icon can be tapped or pressed and hold in the same way with status bar.

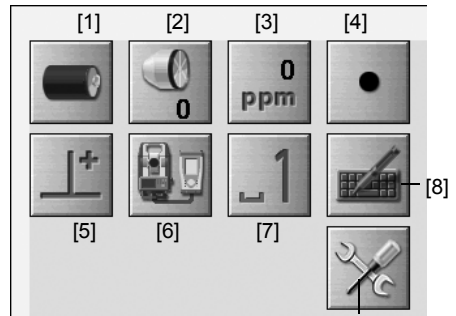

Setting icon

Tap Setting icon to enter the setting mode.

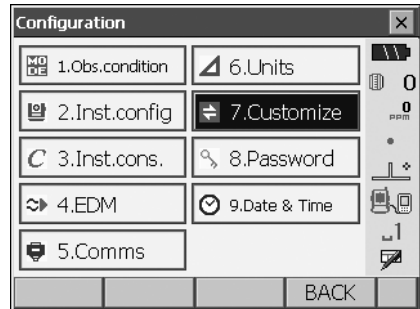

### 5.3 Disk Capacity

Disk usage of the instrument is displayed as follows.

Tap and hold disk icon in the status bar to check the detail of the disk usage.

 "20.7 Changing Status Bar Icons"



:Less than 20%



:20 to 50%



:More than 50%

Internal disk	
Used space	???? KB
Free space	???? KB
Capacity	???? KB
Removable Disk	
Used space	???? KB
Free space	???? KB
Capacity	???? KB

**Internal Disk**

Used space: Usage space of disk capacity of the instrument  
Free space: Free space of disk capacity of the instrument  
Capacity: Disk capacity of the instrument

**Removable Disk**

Used space: Usage space of disk capacity of the external disk connected to the instrument  
Free space: Free space of disk capacity of the external disk connected to the instrument  
Capacity: Disk capacity of the external disk connected to the instrument





- "Removable Disk" is displayed only when an external disk is connected to the instrument.

## 5.4 Inputting Characters using the Input Panel

Tap  or press **{α}** and **{SHIFT}** to display <Input Panel>. This keyboard can be used to input numeric and alphabetic characters as well as symbols. Tap the icon again to close.

### Note

- When <Input Panel> is covering the  icon of the status bar, use the stylus pen to drag the input panel to another part of the screen so that you can access the  icon.

### Input panel

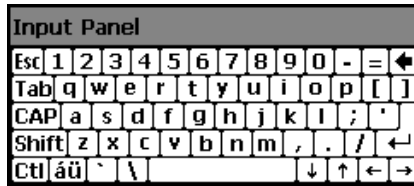

Esc	: Deletes all input characters
Tab	: Moves the cursor to the next text box
CAP	: Alternates between upper and lower case alphabetic characters and numbers/symbols
Shift	: Alternates between upper and lower case alphabetic characters and numbers/symbols. Is canceled after inputting a single character.
Ctl	: No function
Del/↵	: Delete the character to the left/right or deletes the entire text in the active section
←→	: Move the cursor left/right
ENT	: Accept input characters
Space	: Input a blank space
áü	: Accesses further Latin/Germanic characters/symbols. Is canceled after inputting a single character.

# 6. INSERTING USB MEMORY



- When reading/writing data, do not remove the USB memory.

## Procedure

---

1. Open the external interface hatch by sliding its button.

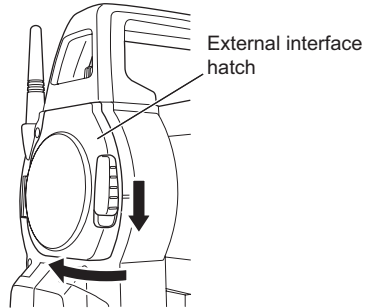

2. Insert the USB memory into the USB port 1.



- When using a USB memory with 4 metal terminals on the surface, insert it with the terminal facing backwards to avoid damaging the USB port.

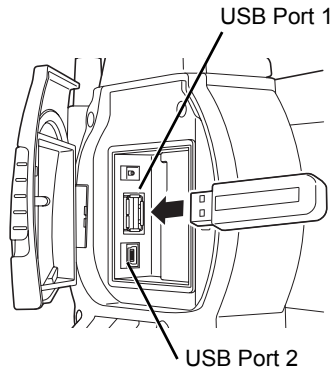

3. Close the external interface hatch until a click is heard.

# 7. USING THE BATTERY

Types of power source: "23. POWER SUPPLY SYSTEM"

## 7.1 Battery Charging

The battery was not charged at the factory. Charge the battery fully before using the FX.



- The charger will become rather hot during use. This is normal.
- Do not use to charge batteries other than those specified.
- The charger is for indoor use only. Do not use outdoors.
- Batteries cannot be charged, even when the charging lamp is flashing, when the temperature is outside the charging temperature range.
- Remove batteries from the charger before putting into storage.
- When not in use, disconnect the power cable plug from the wall outlet.
- Store the battery in a dry room where the temperature is within the following ranges

Storage period	Temperature range
1 week or less	-20 to 50°C
1 week to 1 month	-20 to 45°C
1 month to 6 months	-20 to 40°C
6 months to 1 year	-20 to 35°C

For long-term storage, the battery should be charged at least once every six months.

- Batteries generate power using a chemical reaction and as a result have a limited lifetime. Even when in storage and not used for long periods, battery capacity deteriorates with the passage of time. This may result in the operating time of the battery shortening despite having been charged correctly. In this event, a new battery is required.

### PROCEDURE

1. Connect the power cable to the charger and plug the charger into the wall outlet.
2. Mount the battery in the charger by matching the grooves on the battery with the guides on the charger.

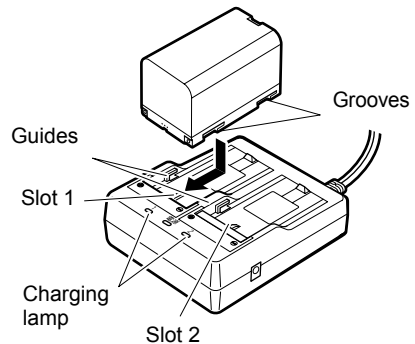

## 7. USING THE BATTERY

---

3. When charging starts, the lamp starts blinking.
4. The lamp lights when charging is finished.
5. Remove the battery and unplug the charger.

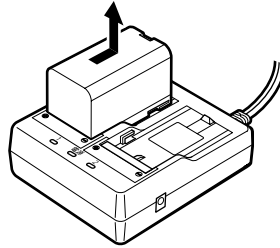

### Note

- Slots 1 and 2:  
The charger starts charging the battery mounted first. If you place two batteries in the charger, the battery in slot 1 is charged first, and then the battery in slot 2. (☞ step 2)
- Charging lamp:  
The charging lamp is off when the charger is outside the charging temperature range or when the battery is mounted incorrectly. If the lamp is still off after the charger falls within its charging temperature range and the battery is mounted again, contact your local dealer. (☞ steps 2 and 3)
- Charging time per battery (at 25°C):  
BDC70: about 5.5 hours

## 7.2 Installing/Removing the Battery

Mount the charged battery.



- Before removing the battery, turn off the power to the instrument. If the battery is removed while the power is switched on, a warm boot occurs. File and folder data may be lost as a result.
- When installing/removing the battery, make sure that moisture or dust particles do not come in contact with the inside of the instrument.
- Remove batteries from the surveying instrument or charger before putting into storage.



**PROCEDURE Mounting the battery**

1. Slide down the catches on the battery cover to open.

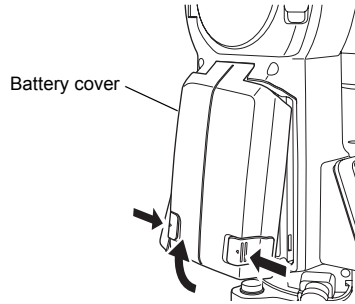

2. Insert the battery in the direction of the arrow on the side of the battery.



- Do not insert the battery inclined. Doing so may damage the instrument or battery terminals.

3. Close the battery cover. A click is heard when the cover is secure.

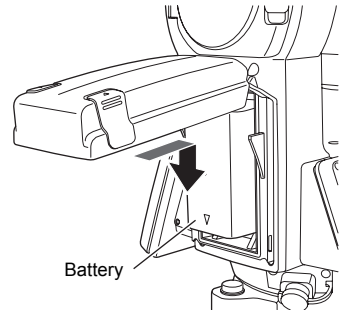

# 8. SETTING UP THE INSTRUMENT



- Mount the battery in the instrument before performing this operation because the instrument will tilt slightly if the battery is mounted after levelling.

## 8.1 Centering

### PROCEDURE Centering with the optical plummet eyepiece

1. Make sure the legs are spaced at equal intervals and the head is approximately level. Set the tripod so that the head is positioned over the survey point. Make sure the tripod shoes are firmly fixed in the ground.

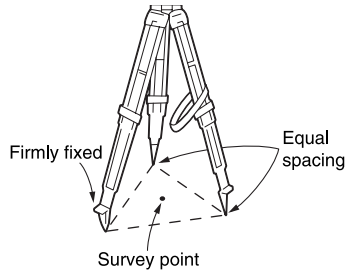

2. Place the instrument on the tripod head. Supporting it with one hand, tighten the centering screw on the bottom of the unit to make sure it is secured to the tripod.

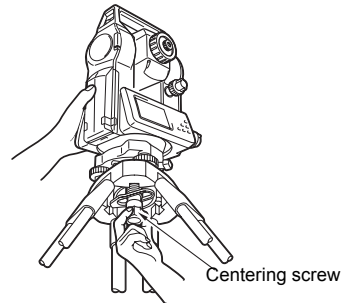

3. Looking through the optical plummet eyepiece, turn the optical plummet eyepiece to focus on the reticle. Turn the optical plummet focussing ring to focus on the survey point.

Focussing on the survey point

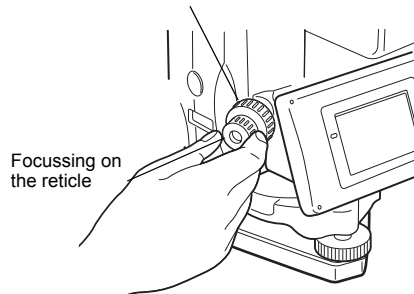

**PROCEDURE Centering with the laser plummet (Option)**

1. Set up the tripod and affix the instrument on the tripod head.

 "8.1 Centering"

2. Press **{ON}** to power on

 "9. POWER ON/OFF"

The electric circular level (tilt) is displayed on the screen.

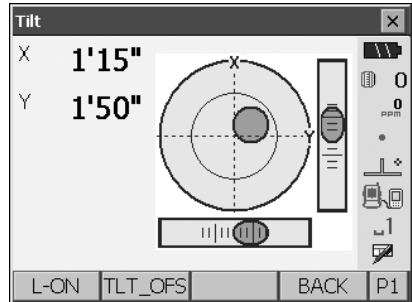

3. Press **[L-ON]**.

The laser plummet beam will be emitted from the bottom of the instrument.

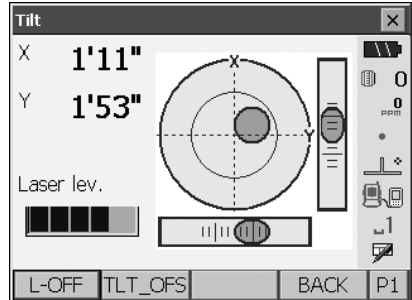

4. Use **[-]/[+]** on the second page to adjust the brightness of the laser.

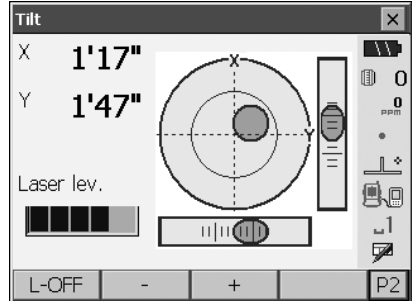

5. Adjust the position of the instrument on the tripod until the laser beam is aligned with the center of the survey point.
6. Press **[L-OFF]** to turn the laser plummet off. Alternatively, press **{ESC}** to return to another screen. The laser plummet will switch off automatically.

## 8. SETTING UP THE INSTRUMENT

### Note

- Visibility of the laser spot may be affected when operating in direct sunlight. In this event, provide shade for the survey point.

## 8.2 Levelling

Instrument can be levelled using the screen.

 "Note" Levelling on the screen"

### PROCEDURE

1. Adjust the levelling foot screws to center the survey point in the optical plummet reticle.

2. Center the bubble in the circular level by either shortening the tripod leg closest to the offcenter direction of the bubble or by lengthening the tripod leg farthest from the offcenter direction of the bubble. Adjust one more tripod leg to center the bubble.

Turn the levelling foot screws while checking the circular level until the bubble is centered in the center circle.

3. Press  to power on.  
"●" indicates the bubble in circular level. The range of the inside circle is  $\pm 1.5'$  and the range of the outside circle is  $\pm 6'$ .

4. Center "●" in the circular level.  
When the bubble is in the center, proceed to step 7.

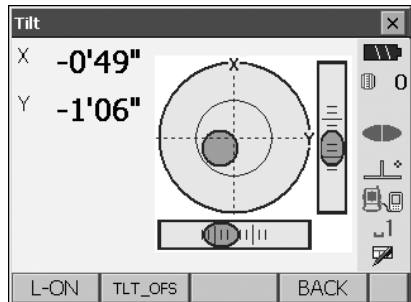
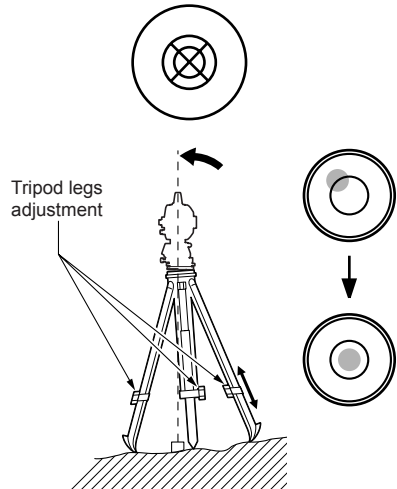

- Turn the instrument until the telescope is parallel to a line between levelling foot screws A and B.

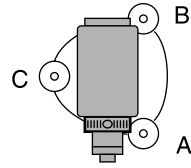

- Set the tilt angle to  $0^\circ$  using foot screws A and B for the X direction and levelling screw C for the Y direction.
- Loosen the centering screw slightly. Looking through the optical plummet eyepiece, slide the instrument over the tripod head until the survey point is exactly centered in the reticle. Retighten the centering screw securely.

If the instrument is levelled using laser plummet, emit the laser plummet beam and check it again.

 "8.1 Centering PROCEDURE Centering with the laser plummet (Option)"

- Check again to make sure the bubble in the electric circular level is centered. If not, repeat the procedure starting from step 6.
- Press **{ESC}** to return to Observation mode.

# 9. POWER ON/OFF

## PROCEDURE Power ON

---

1. Press {  }.

When the power is switched on, the Tilt screen is displayed.

Press { **ESC** } to go to top menu.

If "Out of range" is displayed, the instrument tilt sensor is indicating that the instrument is out of level. Level the instrument once again using circular level, then the tilt screen will be displayed.



- "Tilt crn." in "Obs. condition" should be set to "No" if the display is unsteady due to vibration or strong wind.

 "20.1 Observation Conditions"



### Resume function

The Resume function redisplay the screen appearing before the instrument was powered OFF when the instrument is powered back ON. All parameter settings are also saved. Even if remaining battery power is completely depleted, this function will remain active for 1 minute, after which it is canceled. Replace a depleted battery as soon as possible.

## PROCEDURE Power OFF

---

Press {  } and hold (about 1sec).



- When there is almost no battery power remaining, the battery mark in the status bar will start to blink. In this event, stop measurement, switch off the power and charge the battery or replace with a fully charged battery.

- To save power, power to the FX is automatically cut off if it is not operated for a fixed period of time. This time period can be set in "Power off" in

<Inst.config.>.

 "20.2 Instrument Configuration"

## 9.1 Configuring the Touch Panel

When using for the first time, or after performing a cold boot, the screen for configuring the touch panel will be displayed.

Follow the instructions on the screen. Tap the cross-hairs at the center of the display with the stylus pen. Tap 5 times. Press **{ENT}** to complete touch panel configuration. Press **{ESC}** to retain previous settings.



- Touch panel configuration can be performed at any time during normal operation by pressing **[PNL CAL]** in <Inst.config.>.
  - "20.2 Instrument Configuration"

Carefully press and briefly hold stylus on the center of the target. Repeat as the target moves around the screen. Press the Esc key to cancel.



## 9.2 Resolving Software Issues

If you are experiencing problems with the FX and suspect a fault in the program, you should try a warm boot. If the problem is not resolved with a warm boot the next step is to perform a cold boot. A warm boot will not erase surveying data in FX but will cancel the resume function. Whenever possible transmit the data to a personal computer before rebooting.

### PROCEDURE

1. Power OFF the instrument.
2. Press **{⓪}** while pressing **{ENT}**.  
The instrument is reset and powers ON as normal.



#### Cold boot

If the problem is not resolved with a warm boot the next step is to perform a cold boot. A cold boot will not erase surveying data in FX but all the parameters will be changed to the factory settings. If the data in the memory is necessary, **BE SURE TO TRANSFER IT TO A PERSONAL COMPUTER BEFORE PERFORMING A COLD BOOT.**

To perform a cold boot, while holding **{☼}**, and **{S.P.}**, press **{⓪}**.  
The instrument is reset and powers ON as normal.

"20.11 Restoring Default Settings"



### Problems Powering OFF

When the instrument cannot be powered OFF as normal, depress the reset button with the tip of the stylus pen.

- Pressing the Reset button may result in file and folder data being lost.

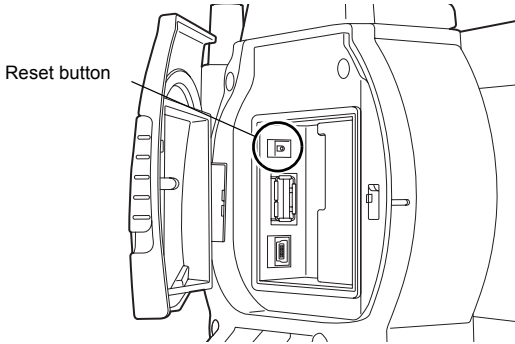



# 10.CONNECTING TO EXTERNAL DEVICES

The FX supports *Bluetooth* wireless technology, USB and RS232C for communication with data collectors etc.

Read this manual in conjunction with the operator's manual for the relevant external device.

 *Bluetooth* communication: "4.3 Bluetooth Wireless Technology"

Output format and command operations: "Communication manual"



- *Bluetooth* communication is only possible with instruments incorporating the *Bluetooth* module.

## 10.1 Wireless Communication using *Bluetooth* Technology

The *Bluetooth* module incorporated in the FX can be used for communication with Bluetooth devices such as data collectors.



### *Bluetooth* connections

Communication between a pair of *Bluetooth* devices requires one device to be set as the "Master" and the other as the "Slave". To initiate connections from the FX side, set the FX as the "Master" device. To initiate connections from the paired device side, set the FX as the "Slave" device. The factory setting is "Slave".

### PROCEDURE Necessary settings for *Bluetooth* communication

1. Select "Comms" in Config mode. Set Comms mode in the "Comms setup" tab to "*Bluetooth*".



- Changing communication settings during *Bluetooth* communication will cancel the connection.
- The  status bar icon cannot be tapped in <Communication Setup>.

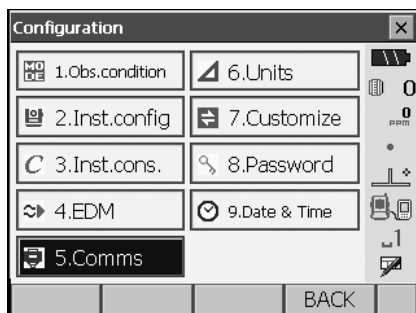

#### Items set and options (\*: Factory setting)

- (1) Communication setup RS232C\*/*Bluetooth*
- (2) Check sum yes/No\*
- (3) Terminate ETX\*/ETX+CR/  
ETX+CR+LF
- (4) Ack mode Off/On\*



#### Terminate

Select the option Off or On for carriage return (CR) and line feed when collecting measurement data with a computer.



#### ACK mode

When communicating to an external device, the protocol for handshaking can omit the [ACK] coming from the external device so data is not sent again.

On: Standard

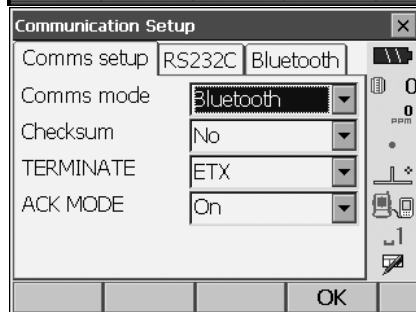

## 10. CONNECTING TO EXTERNAL DEVICES

Off: Omit the **[ACK]**



- Setting '(3) and (4) are for an instrument using GTS commands.

2. Select a mode for the FX in the "*Bluetooth*" tab.

The factory setting is "Slave".

Register companion devices.

- "Master" cannot be selected when no companion devices have been registered.

"Master"/"Slave": " *Bluetooth* connections"

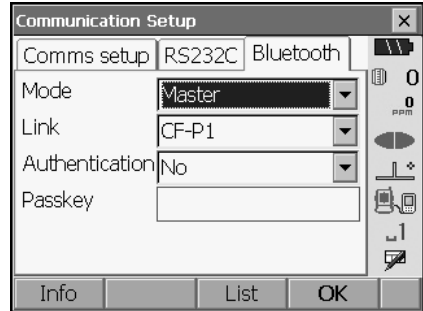

3. Select, in "Link", a companion device from among the *Bluetooth* devices already registered in the FX.

Registering devices: "PROCEDURE Registering *Bluetooth* companion devices"

- Companion devices cannot be selected when the FX is set as "Slave".

4. Set "Authentication" to "Yes" or "No".

If "Authentication" is set to "Yes" for the FX the passkey will also need to be input on the companion device.

5. When "Authentication" is set to "Yes", input the same passkey as that for the intended companion device. Even if "Authentication" is set to "No", a passkey is requested when authentication is set on the companion device being used.

- Up to 16 numeral characters can be input. Input characters will be displayed as asterisks (e.g. "\*\*\*\*\*"). The passkey was set to "0123" at the factory.

6. Press **[OK]** to finish settings.

## PROCEDURE Registering *Bluetooth* companion devices

1. Power on the companion device.
2. Select "*Bluetooth*" in "Comms mode" in the "Comms setup" tab.
3. Press **[LIST]** to display a list of all registered devices.

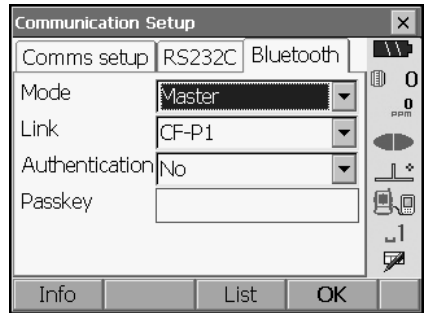

Register the data collectors to use in "Serial" tab and devices to use with the Dial-Up Program in "Dial-up" tab.



- Maximum number of devices registered: 6

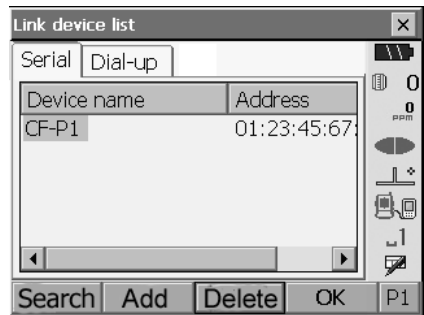

4. Register your *Bluetooth* device(s).

Press **[Add]** to display <Add device>. Input the device name and *Bluetooth* address and press **[OK]**. Both should be 12 characters (numbers 0 to 9 and letters from A to F) in length.



## 10. CONNECTING TO EXTERNAL DEVICES

Press **[Search]** to search about *Bluetooth* devices in the immediate vicinity of the FX and display their device name and address in a list. Select a device from this list and press **[OK]** to add to the Link device list in step 3.

Press **[Delete]** to delete the selected device name. Deleted device names cannot be retrieved.

- Select a device and press **[Edit]** in the second page to update the device name and/or device address.
5. Press **[OK]** to complete registration and return to the screen in step 2.

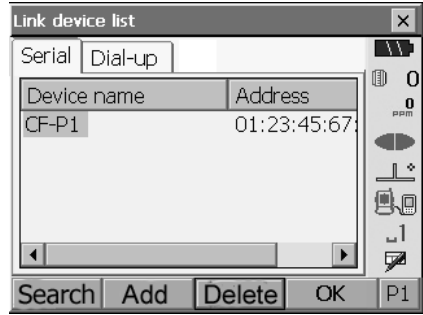

### PROCEDURE Displaying *Bluetooth* information for the FX

1. Select "Comms" in Config mode.
2. Press **[Info]** in the "*Bluetooth*" tab to display information for the FX. Register the *Bluetooth* address (BD ADDR) displayed here in the paired device set as "Master".

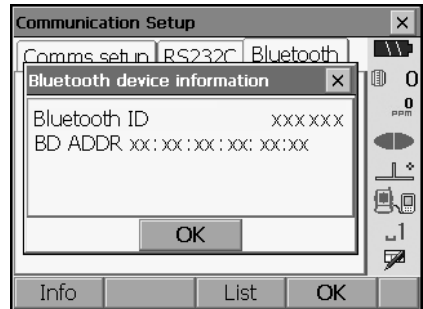

#### **Bluetooth device address**

This is a number unique to one particular *Bluetooth* device used to identify devices during communication. This number consists of 12 characters (numbers 0 to 9 and letters from A to F). Some devices may be referred to by their *Bluetooth* device address.

## 10.2 Communication between the FX and Companion Device



- *Bluetooth* communication causes FX battery power to be depleted at a rate higher than that for normal operation.
- Check that the companion device (data collector, computer, or cellular phone etc.) is turned on and the relevant *Bluetooth* settings are complete.
- All communication settings will be changed to factory settings when a cold boot is performed. Comms setup will need to be performed again.  
 "10.1 Wireless Communication using Bluetooth Technology"

1. Complete the necessary FX settings for *Bluetooth* communication.  
 "10.1 Wireless Communication using Bluetooth Technology"

2. Start communication  
 When FX is set as the "Master" device, the **[Connect]** softkey is allocated to the fourth page of Observation mode. When **[Connect]** is pressed the FX searches for the device selected in "Link" and a connection starts. When a connection has been successfully established is displayed in the status bar.  
 The establishing of a connection can also be initiated by tapping in the status bar.  
 Status bar, communication status:"5.2 Display Functions"



- When FX is set as the "Slave" device, the establishing of a connection can only be initiated/canceled by the companion device set as "Master".
3. Press **[Cancel]** in the fourth page of Observation mode to terminate the connection.  
 A connection can also be terminated by tapping in the status bar.

### 10.3 Connecting to USB devices

FX has two different USB ports. TOPCON CORPORATION cannot guarantee that all USB devices are compatible with the FX USB ports.



- TOPCON CORPORATION cannot guarantee that all USB devices are compatible with the FX USB ports.
- Use a computer WindowsXP/Vista/7 is based and USB connection is capable.

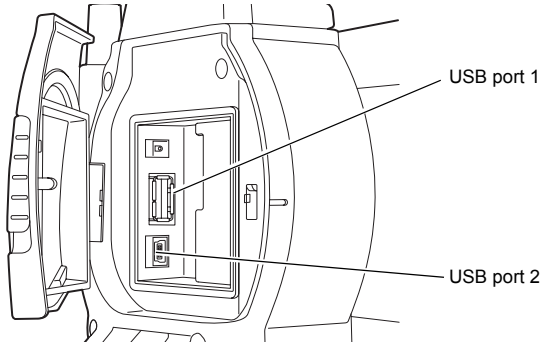

Each port is used for connection to different types of devices.

Port name	Device type
USB port 1	USB memory devices etc.
USB port 2	computers etc.

Using USB port 2, the instrument and a computer can be communicated. There are USB mode and Mobile mode.



- Remove the USB cable from USB port 2 carefully to avoid damaging the cable.

#### Connecting the FX to a computer to transfer data from FX



- As for the download and install of "exFat file system driver"/ActiveSync/Windows Mobile Device Center, please access to Microsoft support site.
- **USB mode connection**  
When connecting Windows XP, "exFat file system driver" needs to be installed to the computer.

1. Power OFF the FX. Connect the FX and computer using the USB cable.

 "9. POWER ON/OFF"

**Note**

- The computer does not need to be turned OFF before connection.

2. Press {  } while pressing {ENT} to display a message box asking whether to boot USB mode, then press [YES].  
The screen of the instrument will be <USB Mode>.

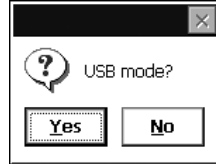

**Note**

- FX may not be displayed as <Removable Disk>. It depends on Windows settings.



Follow the instructions below to ensure that the FX continues to operate normally during USB transfer.

- Do not change the folder hierarchy or folder names in <Removable Disk>.
- Do not format the "removable disk" on the computer.

3. Perform "Safely Remove Hardware"  in the task bar and disconnect the USB cable.

4. Press {  } and hold (about 1sec) to turn off the instrument to exit USB mode connection.

● **Mobile mode connection**

A synchronous software needs to be installed to the computer depending on the Windows version.

Computer to connect	Synchronous software
Windows XP	ActiveSync
Windows vista/7	Windows Mobile Device Center

1. Power OFF the FX. Connect the FX and computer using the USB cable.

 "9. POWER ON/OFF"

**Note**

- The computer does not need to be turned OFF before connection.

## 10. CONNECTING TO EXTERNAL DEVICES

---

2. Press { **ⓘ** } while pressing { **ENT** } to display a message box asking whether to boot USB mode, then press { **NO** }.  
The synchronous software is effective.

### Note

- FX may not be displayed as <Removable Disk>. It depends on Windows settings.



Follow the instructions below to ensure that the FX continues to operate normally during USB transfer.

- Do not change the folder hierarchy or folder names in <Removable Disk>.
  - Do not format the "removable disk" on the computer.
3. If synchronous software displays a partner setting screen on the computer and asks whether to set a partner device, press { **NO** }.

### Note

- A partner setting screen may not be displayed depending on the synchronous software settings.
4. Disconnect the USB cable to exit mobile mode connection.

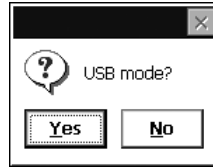



## 10.4 Connection via RS232C cable

### PROCEDURE Basic cable settings

1. Connect the cable.  
 Cables: "25. OPTIONAL ACCESSORIES"

2. Select "Comms" in Config mode.  
 Set communication conditions in the "Comms setup" tab. Set "Comms mode" to "RS232C".

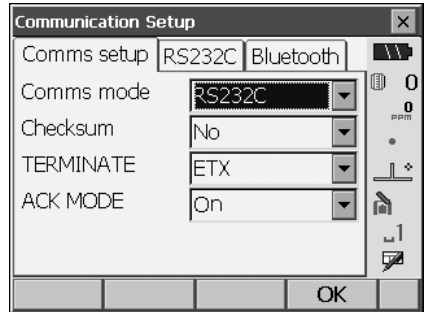

3. Set options in the "RS232C" tab according to the selection made in the "Comms setup" tab.  
 \*: factory settings

Baud rate:	1200/2400/4800/ 9600*/19200/ 38400bps
Data bits:	7/8* bits
Parity:	Not set*/Odd/Even
Stop bit:	1*/ 2 bits

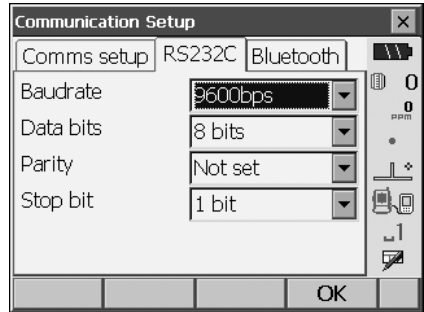

# 11.FOCUSING AND TARGET SIGHTING



- When sighting the target, strong light shining directly into the objective lens may cause the instrument to malfunction. Protect the objective lens from direct light by attaching the lens hood. Observe to the same point of the reticle when the telescope face is changed.

## PROCEDURE

---

### 1. Focus on the reticle

Look through the telescope eyepiece at a bright and featureless background.

Turn the eyepiece screw clockwise, then counterclockwise little by little until just before the reticle image becomes focussed.

Using these procedures, frequent reticle refocussing is not necessary since your eye is focussed at infinity.

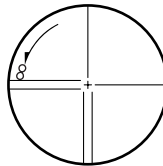

### 2. Sight the target

Loosen the vertical and horizontal clamps, then use the sighting collimator to bring the target into the field of view. Tighten both clamps.

### 3. Focus on the target

Turn the telescope focussing ring to focus on the target.

Turn the vertical and horizontal fine motion screws to align the target with the reticle.

The last adjustment of each fine motion screw should be in the clockwise direction.

### 4. Readjust the focus until there is no parallax

Readjust the focus with the focussing ring until there is no parallax between the target image and the reticle.



### Eliminating parallax

This is the relative displacement of the target image with respect to the reticle when the observer's head is moved slightly before the eyepiece.

Parallax will introduce reading errors and must be removed before observations are taken.

Parallax can be removed by refocussing the reticle.

# 12. ANGLE MEASUREMENT

This section explains the procedures for basic angle measurement in Observation mode.

- It is possible to allocate softkeys in measurement menus to suit various applications and the ways that different operators handle the instrument.

"20.6 Allocating Key Functions"

## 12.1 Measuring the Horizontal Angle between Two Points (Horizontal Angle 0°)

Use the "OSET" function to measure the included angle between two points. The horizontal angle can be set to 0 at any direction.

### PROCEDURE

- Sight the first target as at right.  
 "11. FOCUSING AND TARGET SIGHTING"

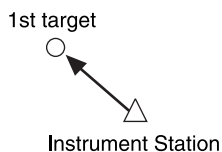

- In the first page of Observation mode, press **[OSET]**.  
**[OSET]** will flash, so press **[OSET]** again.  
The horizontal angle at the first target becomes 0°.

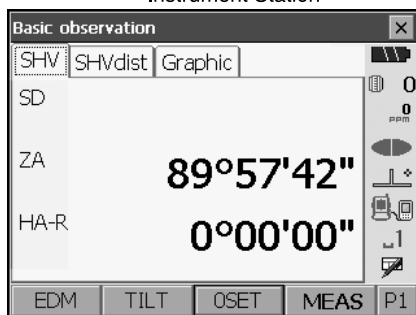

- Sight the second target.

2nd Target

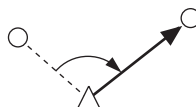

The displayed horizontal angle (HA-R) is the included angle between two points.

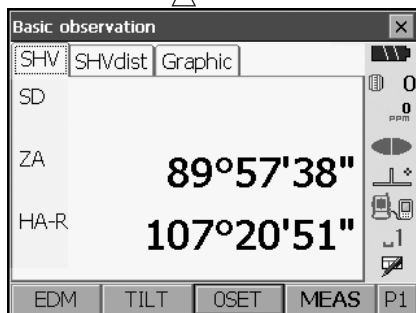

## 12.2 Setting the Horizontal Angle to a Required Value (Horizontal Angle Hold)

You can reset the horizontal angle to a required value and use this value to find the horizontal angle of a new target.

### PROCEDURE

1. Sight the first target.
2. In the second page of Observation mode, press **[H-SET]**. <Set H angle> is displayed.
3. Enter the angle you wish to set, then press **[OK]**. The value that is input as the horizontal angle is displayed.

- The same setting can also be performed with coordinate and azimuth input.  
 "14.2 Azimuth Angle Setting"

4. Press **[OK]** to confirm the input value and display the new horizontal angle.

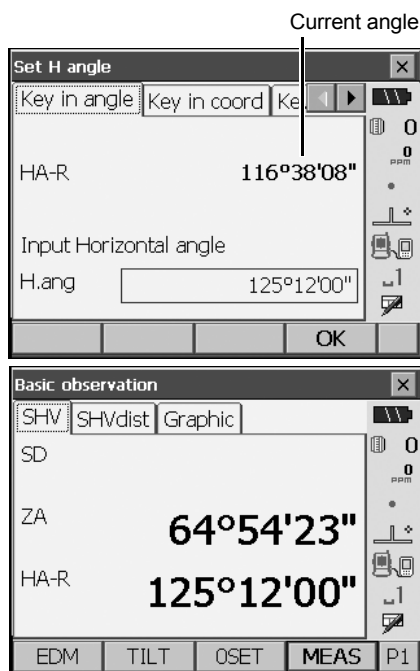

5. Sight the second target.  
The horizontal angle from the second target to the value set as the horizontal angle is displayed.

#### Note

- Pressing **[HOLD]** performs the same function as above.
- Press **[HOLD]** to set the displayed horizontal angle. Then, set the angle that is in hold status to the direction you require.  
 Allocating **[HOLD]**: "20.6 Allocating Key Functions"

## 12.3 Angle measurement and Outputting the Data

The following explains angle measurement and the features used to output measurement results to a computer or other external devices.

 "10. CONNECTING TO EXTERNAL DEVICES", Cables: "25. OPTIONAL ACCESSORIES",  
Output format and command operations: "Communication manual"

### PROCEDURE

1. Connect FX and external device.
2. Allocate the **[HVOUT-T]** or **[HVOUT-S]** softkey to the OBS mode screen.  
 "20.6 Allocating Key Functions"

#### Note

- Pressing the softkey outputs data in the following format.

**[HVOUT-T]** : GTS format

**[HVOUT-S]** : SET format

3. Sight the target point.
4. Press **[HVOUT-T]** or **[HVOUT-S]**.  
Output measurement data to peripheral equipment.

# 13.DISTANCE MEASUREMENT

Perform the following settings as preparation for distance measurement in Observation mode.

- Distance measurement mode
- Target type
- Prism constant correction value
- ppm
- EDM ALC
  - ☞ "20.2 Instrument Configuration"
- It is possible to allocate softkeys in measurement menus to suit various applications and the ways that different operators handle the instrument.
  - ☞ "20.6 Allocating Key Functions"

## Caution

- When using the laser-pointer function, be sure to turn OFF the output laser after distance measurement is completed. Even if distance measurement is canceled, the laser-pointer function is still operating and the laser beam continues to be emitted.



- Make sure that the target setting on the instrument matches the type of target used. FX automatically adjusts the intensity of the laser beam and switches the distance measurement display range to match the type of target used. If the target does not correspond to the target settings, accurate measurement results cannot be obtained.
- Accurate measurement results cannot be obtained if the objective lens is dirty. Dust it off with the lens brush first, to remove minute particles. Then, after providing a little condensation by breathing on the lens, wipe it off with the wiping cloth.
- During reflectorless measurement, if an object with a high reflective factor (metal or white surface) is positioned between the FX and the target, accurate measurement results may not be received.
- Scintillation may affect the accuracy of distance measurement results. Should this occur, repeat measurement several times and use the averaged value of the obtained results.

## 13.1 Returned Signal Checking

Check to make sure that sufficient reflected light is returned by the target sighted by the telescope. Checking the returned signal is particularly useful when performing long distance measurements.

## Caution

- The laser beam is emitted during returned signal checking.



- When the light intensity is sufficient even though the center of the reflective prism and the reticle are slightly misaligned (short distance etc.), "●" will be displayed in some cases, but in fact, accurate measurement is impossible. Therefore make sure that the target center is sighted correctly.

## PROCEDURE

1. Accurately sight the target.
2. Press **[S-LEV]** in observation mode.  
<Aiming> is displayed.  
☞ Allocating **[S-LEV]**: "20.6 Allocating Key Functions"

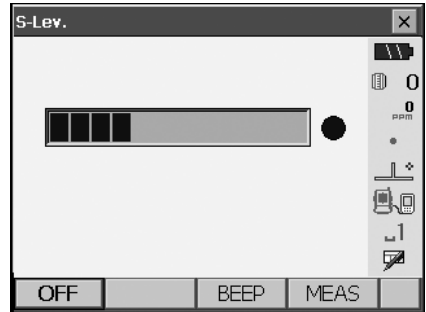

When **[S-LEV]** is pressed, a gauge indicating light intensity is displayed.

- The more ████████ displayed, the greater the quantity of reflected light.
- If "●" is displayed, only enough light for the measurement is returned.
- When "●" is not displayed, accurately resight the target.

**[BEEP]/[OFF]**: Sets a buzzer sound when measurement is possible. Press to switch on and off.

**[MEAS]**: Returns to Observation mode and starts angle and distance measurement.

3. Press **[OFF]** to finish signal checking.  
Press **{ESC}** or tap the cross in the top-right corner to return to the previous screen.

### Note

- When ████████ is displayed persistently, but "●" is not, contact your local dealer.
- If no key operations are performed for two minutes, the display automatically returns to the previous screen.

## 13.2 Distance and Angle Measurement

An angle can be measured at the same time as distance.

### PROCEDURE

1. Face the FX in the direction of the target  
Use the sighting collimator to aim the FX and telescope toward the target.  
☞ "11. FOCUSING AND TARGET SIGHTING"

2. Start measurement.  
Press **[MEAS]** in the first page of Observation mode to start measurement.

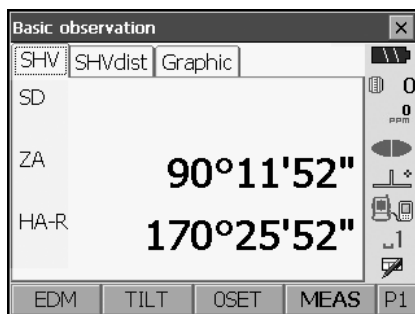

The measured distance data (SD), vertical angle (ZA), and horizontal angle (HA-R) are displayed.

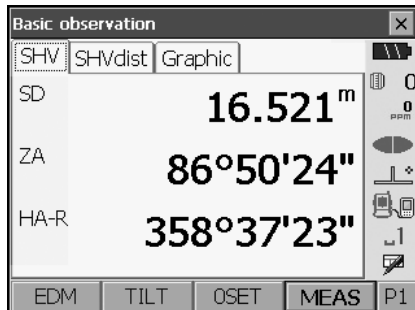

3. Press **[STOP]** to quit distance measurement.



- If the single measurement mode is selected, measurement automatically stops after a single measurement.
- During fine average measurement, the distance data is displayed as SD1, SD2,... to SD9. When the designated number of measurements has been completed, the average value of the distance is displayed in the "SDA" line.
- The distance and angle that are most recently measured remain stored in the memory until the power is off and can be displayed at any time by pressing **[CALL]**.  
☞ Allocating **[CALL]**: "20.6 Allocating Key Functions"



### 13.3 Distance Measurement and Outputting the Data

The following explains distance measurement and the features used to output measurement data to a computer or external devices.

 "10. CONNECTING TO EXTERNAL DEVICES", Communication cables: "25. OPTIONAL ACCESSORIES". Output format and command operations: "Communication manual"

#### PROCEDURE

---

1. Connect FX and external device.
2. Sight the target point.
3. Press **[HVDOUT-T]** or **[HVDOUT-S]** to measure the distance and output the data to the external device.
4. Press **[STOP]** to stop outputting data and return to Obs Mode.

**13.4 REM Measurement**

An REM measurement is a function used to measure the height to a point where a target cannot be directly installed such as power lines, overhead cables and bridges, etc. The height of the target is calculated using the following formula.

$$Ht = h_1 + h_2$$

$$h_2 = S \sin \theta_{z1} \times \cot \theta_{z2} - S \cos \theta_{z1}$$

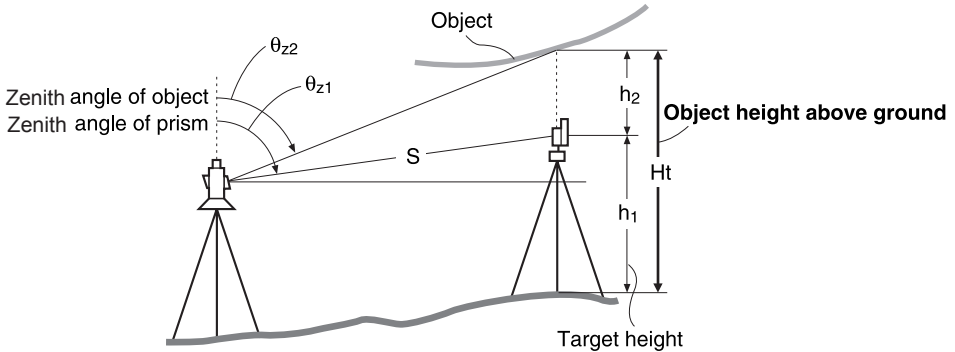

- It is possible to allocate softkeys in measurement menus to suit various applications and the ways that different operators handle the instrument.  
 [Icon] "20.6 Allocating Key Functions"

**PROCEDURE**

1. Set the target directly under or directly over the object and measure the target height with a tape measure etc.

Press **[HT]** and enter the target height.

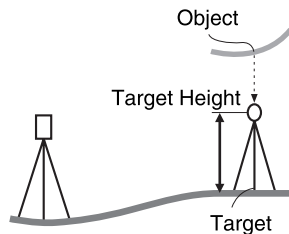

2. Select "REM" in <Menu>.

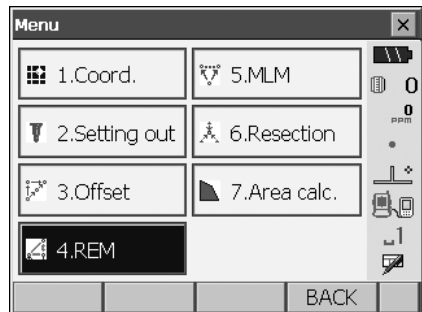

3. Sight the target and press **[MEAS]** to start measurement. Press **[STOP]** to stop the measurement.

Remote elevation		X
Need base point obs.		
SD		0 ppm
ZA	98°08'53"	0
HA-R	359°34'30"	1
HT	MEAS	

The measured distance data, vertical angle and horizontal angle are displayed.

Remote elevation		X
Ht.		0 ppm
SD	6.165 m	0
ZA	98°07'53"	1
HA-R	359°34'41"	
HT	MEAS	REM

4. Sight the object, then press **[REM]** to start REM measurement is started. The height from the ground to the object is displayed in "Ht.". Press **[STOP]** to stop the measurement.

- To re-observe the target, sight the target then press **[MEAS]**.
- To continue REM measurement, press **[REM]**.

Remote elevation		X
Ht.	1.100 m	0 ppm
SD	6.165 m	0
ZA	64°50'23"	1
HA-R	359°33'31"	
HT	MEAS	REM

#### Note

- When measurement data already exists, select "REM" in <Menu> as in step 2 to proceed to step 4 and start REM measurement. Press **[STOP]** to stop the measurement.

# 14.COORDINATE MEASUREMENT

By performing coordinate measurements it is possible to find the 3-dimensional coordinates of the target based on station point coordinates, instrument height, target height, and azimuth angles of the backsight station which are entered in advance.

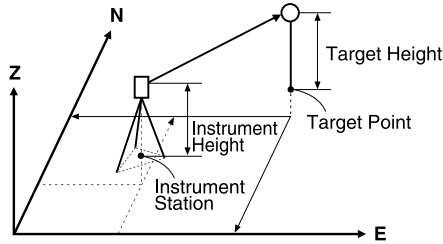

- It is possible to allocate softkeys in measurement menus to suit various applications and the ways that different operators handle the instrument.  
☞ "20.6 Allocating Key Functions"

## 14.1 Entering Instrument Station Data

Before performing coordinate measurement, enter instrument station coordinates and instrument height.

Note

- "Occupy" on the software represents instrument station.

### PROCEDURE

1. First measure the instrument height with a tape measure, etc.
2. Select "Coord." in <Menu>.

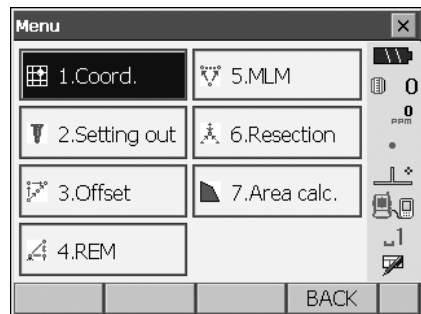

3. Select "Occupy setup" and enter instrument station coordinates, instrument height (HI) and target height (HR).

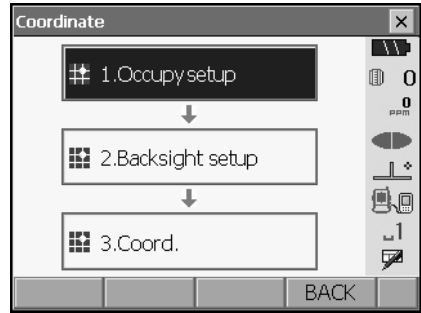

4. Press **[OK]** to set the input values. <Set H angle> is displayed again.

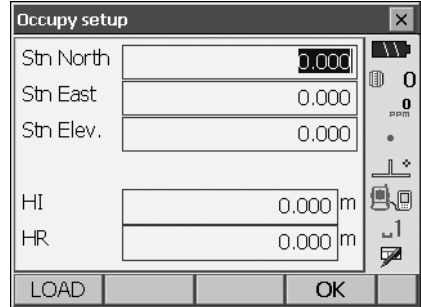

## 14.2 Azimuth Angle Setting

Based on the instrument station coordinates and backsight station coordinates which have already been set, the azimuth angle of the backsight station is calculated.

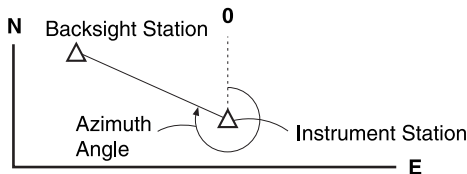

## 14. COORDINATE MEASUREMENT

### PROCEDURE Entering coordinates

1. Select "Backsight setup" in <Coordinate>. <Set H angle> is displayed.

- <Set H angle> can also be displayed from the screen in step 4 of "14.1 Entering Instrument Station Data".

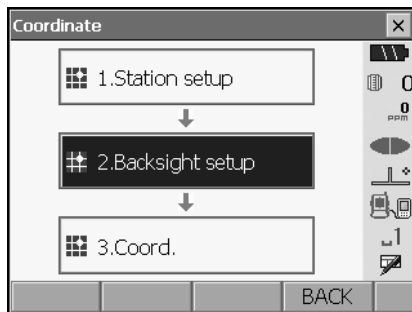

2. Select the "Key in coord" tab and enter the backsight station coordinates.

- **[Azimuth]**: Switches horizontal angle setting method.  
☞ "D Horizontal angle settings"

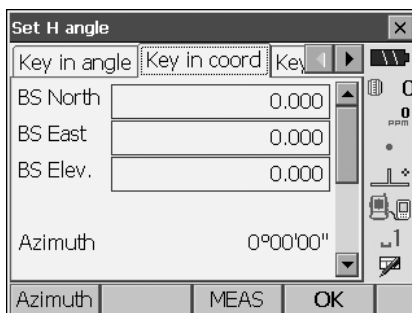

- Sight the backsight station and press **[MEAS]**. Press **[STOP]** to display the distance calculated from coordinates, the measured distance, and the difference between the two. Press **[YES]** to set the azimuth angle and display <Coord. measurement>.

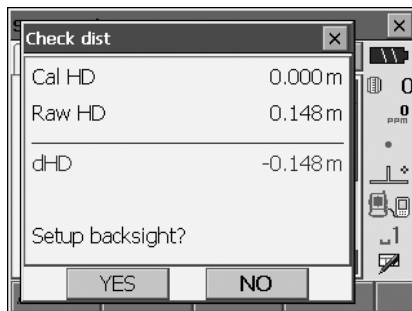

3. Press **[OK]** to set the azimuth angle. <Coord. measurement> is displayed.

### PROCEDURE Entering angle

1. Select "Backsight setup" in <Coordinate>. <Set H angle> is displayed.
- <Set H angle> can also be displayed from the screen in step 4 of "14.1 Entering Instrument Station Data".
2. Select the "Key in angle" tab and enter the desired angle in "H.ang".

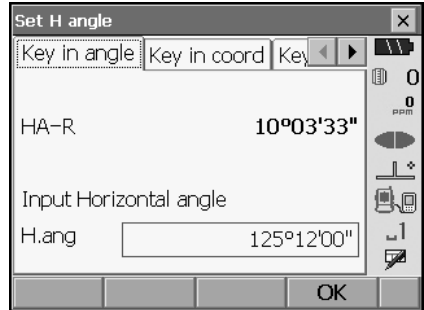

3. Press **[OK]** to set the input values. <Coord. measurement> is displayed.

### PROCEDURE Entering azimuth

1. Select "Backsight setup" in <Coordinate>. <Set H angle> is displayed.
- <Set H angle> can also be displayed from the screen in step 4 of "14.1 Entering Instrument Station Data".
2. Select the "Key in azimuth" tab and enter the desired angle in "Azimuth".

- **[Azimuth]**: Switches horizontal angle setting method.  
 "D Horizontal angle settings"

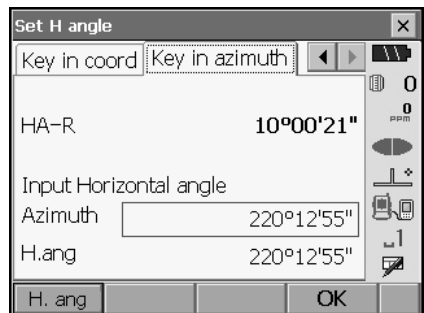

## 14. COORDINATE MEASUREMENT

3. Press **[OK]** to set the input values. <Coord. measurement> is displayed.



### Horizontal angle settings

Azimuth (set both horizontal and azimuth angles to the same value)/H.ang (input both horizontal and azimuth angles)/None (input azimuth angle only)/0 SET (horizontal angle set to 0°)

## 14.3 3-D Coordinate Measurement

The coordinate values of the target can be found by measuring the target based on the settings of the instrument station and backsight station.

The coordinate values of the target are calculated using the following formulae.

$$N1 \text{ Coordinate} = N0 + S \times \sin Z \times \cos Az$$

$$E1 \text{ Coordinate} = E0 + S \times \sin Z \times \sin Az$$

$$Z1 \text{ Coordinate} = Z0 + S \times \cos Z + ih - th$$

N0: Station point N coordinate    S: Slope distance    ih: Instrument height

E0: Station point E coordinate    Z: Zenith angle    th: Target height

Z0: Station point Z coordinate    Az: Direction angle

"Null" coordinates will not be included in calculations. "Null" is not the same as zero.

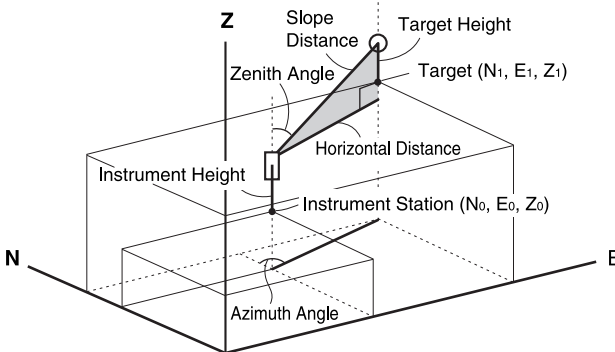



---

**PROCEDURE**

---

1. Sight the target at the target point.
2. Select "Coord." in <Coordinate>.

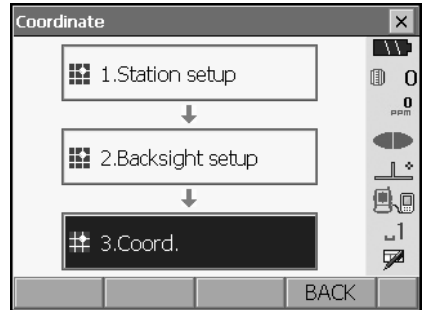

Press **[MEAS]** to start measurement. Press **[STOP]** to stop the measurement. The coordinates of the target point are displayed. Select the "Graphic" tab to display coordinates on a graph.

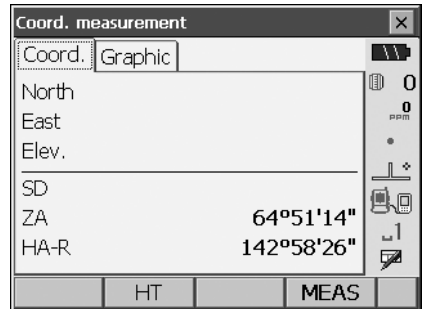



3. Sight the next target and press **[MEAS]** to begin measurement. Continue until all targets have been measured.
4. When coordinate measurement is completed, press **{ESC}** or tap the cross in the top-right corner to return to <Coordinate>.

# 15. RESECTION MEASUREMENT

Resection is used to determine the coordinates of an instrument station by performing multiple measurements of points whose coordinate values are known. Registered coordinate data can be recalled and set as known point data. Residual of each point can be checked, if necessary.

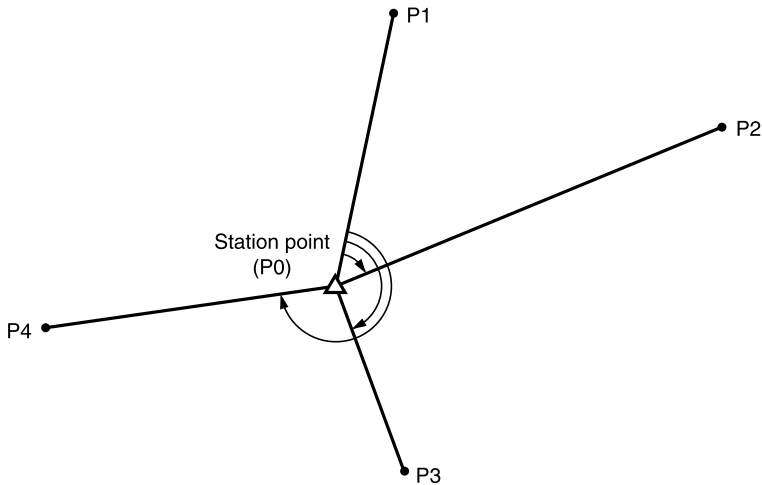
Entry	Output
Coordinates of known point : $(N_i, E_i, Z_i)$	Station point coordinates : $(N_0, E_0, Z_0)$
Observed horizontal angle : $H_i$	
Observed vertical angle : $V_i$	
Observed distance : $D_i$	



- Between 2 and 10 known points can be measured by distance measurement, and between 3 and 10 known points by angle measurement.
  - The more known points there are and the more points there are whose distance can be measured, the higher the precision of the coordinate value calculation.
  - It is possible to allocate softkeys in measurement menus to suit various applications and the ways that different operators handle the instrument.
-  "20.6 Allocating Key Functions"

## 15.1 Coordinate Resection Measurement

N, E, Z of an instrument station is determined by the measurement.

### PROCEDURE

1. Select "Resection" in <Menu>.

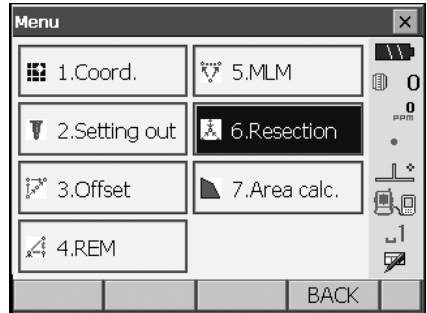

2. Select "NEZ" to display <Resection/Known point>.

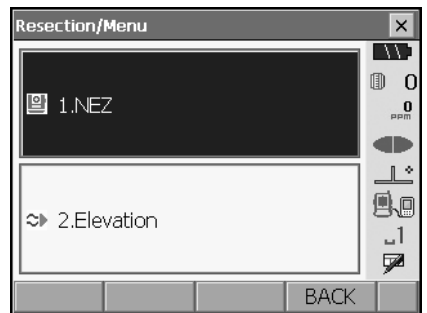

3. Input the known point.  
After setting the coordinates and target height for the first known point press **[NEXT]** to move to the second point.

- Press **[PREV]** to return to settings for the previous point.

When all required known points have been set, press **[OK]**.

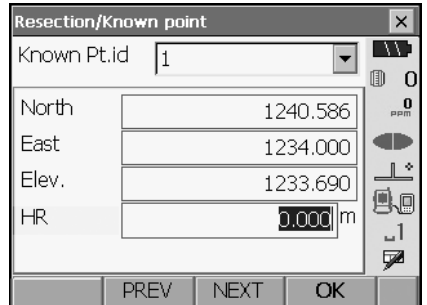

## 15. RESECTION MEASUREMENT

4. Sight the first known point and press **[MEAS]** to begin measurement.

The measurement results are displayed on the screen.

- When **[ANGLE]** has been selected, the distance cannot be displayed.

Resection/ Observation known points	
Known Pt.id	1
North	1240.586
East	1234.000
Elev.	1233.690
SD	1.865 m
ZA	90°43'22"
HA-R	249°01'55"

ANGLE MEAS

5. Press **[YES]** to use the measurement results of the first known point.

- You can also input target height here.
- Press **[NO]** to return to the screen in step 4 and perform measurement again.

Resection/result	
SD	5.018 m
ZA	92°59'42"
HA-R	246°11'09"
HR	<input type="text" value="0.000"/> m

YES NO

6. Repeat procedures 4 to 5 in the same way from subsequent points.

When the minimum quantity of observation data required for the calculation is present, **[CALC]** is displayed.

Resection/result	
SD	5.279 m
ZA	90°00'07"
HA-R	242°29'06"
HR	<input type="text" value="0.000"/> m

CALC YES NO

7. Press **[CALC]** or **[YES]** to automatically start calculations after observations of all known points are completed.

- Instrument station coordinates, station elevation, and standard deviation, which describes the measurement accuracy, are displayed.

Resection/result	
Result	Detail
Occ.North	4.568
Occ.East	2.346
Occ.Elev.	3.012
$\sigma$ N	0.0071
$\sigma$ E	0.0038
$\sigma$ Z	0.0001

RE\_OBS OK

Standard deviation for the northing, easting and elevation coordinates of each point are displayed in the "Detail" tab.

	$\sigma Z$
1st	0.123
2nd	0.123

8. If there are problems with the results of a point, align the cursor with that point and press **[OMIT]**. "OMIT" is displayed to the right of the point. Repeat for all results that include problems.

	$\sigma N$	$\sigma E$	$\sigma Z$
1st OMIT	-0.004	0.002	-0.001
2nd	0.009	-0.001	0.001

9. Press **[RE\_CALC]** to perform calculation again without the point designated in step 8. The result is displayed.
- If there are no problems with the result, go to step 10.
- If problems with the result occur again, perform the resection measurement from step 4.
- Press **[RE\_OBS]** to measure the point designated in step 8.
- If no points are designated in step 8, all the points or only the final point can be observed again.

## 15. RESECTION MEASUREMENT

- Press **[ADD]** in the second page when there is a known point that has not been observed or when a new known point is added.

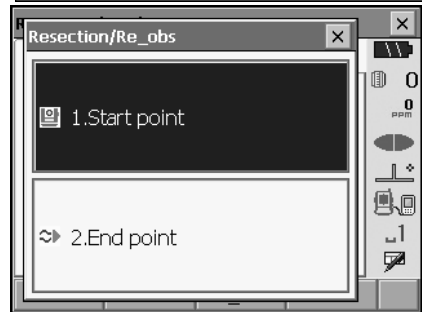
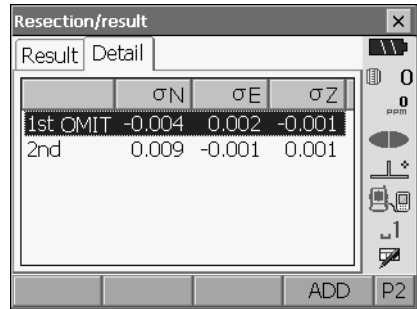

10. Press **[OK]** in <Resection/result> to display <Resection/Set h angle>.
11. Select an angle mode and press **[YES]** to set the azimuth angle of the first known point as the backsight point and return to <Resection/Menu>.
12. Press **[NO]** to return to <Resection/Menu> without setting the azimuth angle.

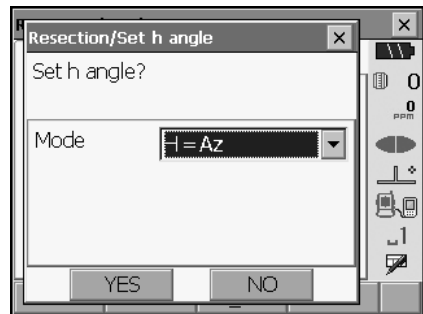

### Horizontal angle settings

H (set horizontal angle to measured value)/H=Az (set horizontal angle to the same value as azimuth angle)/Az (set azimuth angle only)



- It is also possible to perform resection measurement by pressing **[RESEC]** in the third page of Observation mode.

## 15.2 Height Resection Measurement

Only Z (height) of an instrument station is determined by the measurement.

- Known points must be measured by distance measurement only.
- Between 1 and 10 known points can be measured.

### PROCEDURE

1. Select "Resection" in <Menu>.

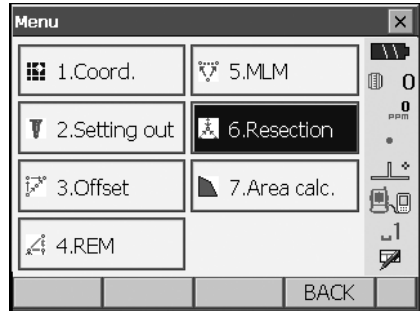

2. Select "Elevation" to display <Resection/Known point>.

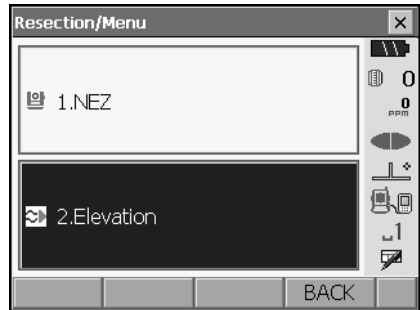

3. Input the known point.  
After setting the elevation and target height for the first known point press **[NEXT]** to move to the second point.
  - Press **[PREV]** to return to settings for the previous point.
 When all required known points have been set, press **[OK]**.

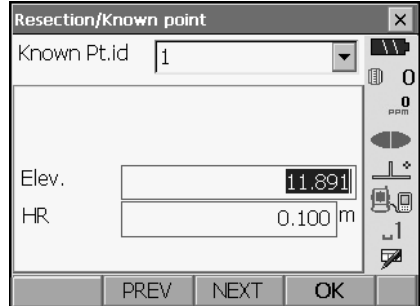

## 15. RESECTION MEASUREMENT

4. Sight the first known point and press **[MEAS]** to begin measurement.  
The measurement results are displayed on the screen.

Known Pt.id	1
Elev.	11.891
SD	5.389m
ZA	89°59'56"
HA-R	3°52'43"

MEAS

5. If measuring two or more known points, repeat procedures 4 in the same way from the second point.

SD	5.389 m
ZA	91°08'52"
HA-R	241°42'02"
HR	0.100 m

CALC YES NO

6. Press **[CALC]** or **[YES]** to automatically start calculations after observations of all known points are completed.
- Instrument station elevation and standard deviation, which describes the measurement accuracy, are displayed in the "Result" tab.

Occ.Elev.	789.012
$\sigma Z$	0.006

RE\_OBS OK

Standard deviation values for each point are displayed in the "Detail" tab.

	$\sigma Z$
1...	0.123
2nd	0.123

OMIT RE\_CALC RE\_OBS OK P1



7. If there are problems with the results of a point, align the cursor with that point and press **[OMIT]**. "OMIT" is displayed to the right of the point. Repeat for all results that include problems.

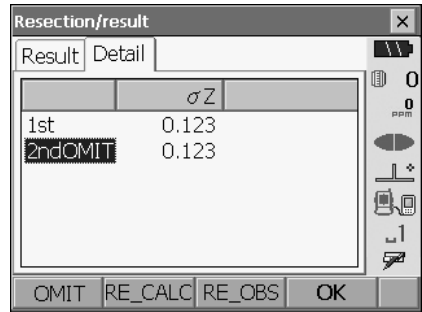

8. Press **[RE\_CALC]** to perform calculation again without the point designated in step 7. The result is displayed. If there are no problems with the result, go to step 9. If problems with the result occur again, perform the resection measurement from step 4.
- Press **[RE\_OBS]** to measure the point designated in step 7.
  - Press **[ADD]** in the second page when there is a known point that has not been observed or when a new known point is added.

If no points are designated in step 7, all the points or only the final point can be observed again.

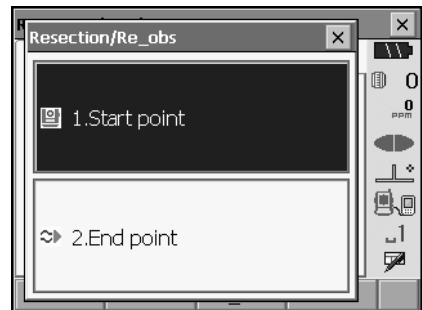

9. Press **[OK]** to finish resection measurement and return to <Resection/Menu>. Only Z (elevation) of the instrument station coordinate is set. N and E values are not overwritten.

## 15. RESECTION MEASUREMENT



### Resection calculation process

The NE coordinates are found using angle and distance observation equations, and the instrument station coordinates are found using the method of least squares. The Z coordinate is found by treating the average value as the instrument station coordinates.

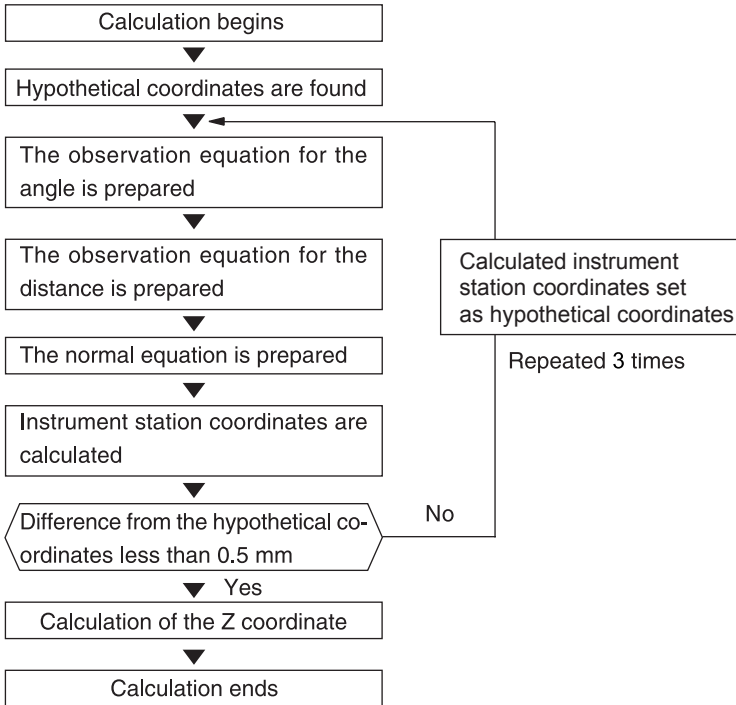



**Precaution when performing resection**

In some cases it is impossible to calculate the coordinates of an unknown point (instrument station) if the unknown point and three or more known points are arranged on the edge of a single circle.

An arrangement such as that shown below is desirable.



It is sometimes impossible to perform a correct calculation in a case such as the one below.

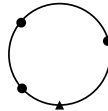

When they are on the edge of a single circle, take one of the following measures.

- (1) Move the instrument station as close as possible to the center of the triangle.

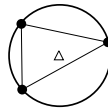

- (2) Observe one more known point which is not on the circle.

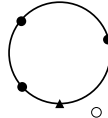

- (3) Perform a distance measurement on at least one of the three points.

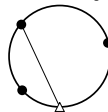

- In some cases it is impossible to calculate the coordinates of the instrument station if the included angle between the known points is too small. It is difficult to imagine that the longer the distance between the instrument station and the known points, the narrower the included angle between the known points. Be careful because the points can easily be aligned on the edge of a single circle.

# 16.SETTING-OUT MEASUREMENT

Setting-out measurement is used to set out the required point.

The difference between the previously input data to the instrument (the setting-out data) and the measured value can be displayed by measuring the horizontal angle, distance or coordinates of the sighted point.

The horizontal angle difference distance difference, and coordinate difference are calculated and displayed using the following formulae.

Horizontal difference

Displayed value (angle) = Horizontal angle of setting-out data - measured horizontal angle

Displayed value (distance) = measured horizontal distance x tan (horizontal angle of setting out data - measured horizontal angle)

Slope distance difference

Displayed value (slope distance) \* = measured slope distance - slope distance setting-out data

\* Horizontal distance or height difference can be input in the above formula.

Coordinate difference

Displayed value (coordinates)\* measured N setting-out coordinates - N coordinates of setting-out data

\* E or Z coordinates can be input in the above formula

Height difference (REM setting out measurement)

Displayed value (height) = measured REM data - REM data of setting out data

- Setting out data can be input in various modes: slope distance, horizontal distance, height difference, coordinates and REM measurement.
- It is possible to allocate softkeys in the Setting-out measurement menu to suit various applications and the ways that different operators handle the instrument.

 "20.6 Allocating Key Functions"

## 16.1 Using the Guide Light

When the guide light is set to ON, the flashing speed of the light indicates the status of the FX and can be known when the user is located at a distance from the instrument. Also, the flashing colors relative to the target indicate the direction of the instrument and allow the user to reposition the target.

 Turning the Guide light ON/OFF: "5.1 Basic Key Operation"

- The pattern of the guide light can be changed.

 "20.2 Instrument Configuration"

### ● Guide light status and meaning

Indication for positioning target during setting-out measurement

Light status	Meaning
Increased flashing speed	(From position of poleman) Move target toward FX
Decreased flashing speed	(From position of poleman) Move target away from FX
Fast flashing	Target is at correct distance
Red	(From position of poleman) Move target left
Green	(From position of poleman) Move target right
Red and Green	Target is at correct horizontal position

## 16.2 Distance Setting-out Measurement

The point is to be found based on the horizontal angle from the reference direction and the distance from the instrument station.

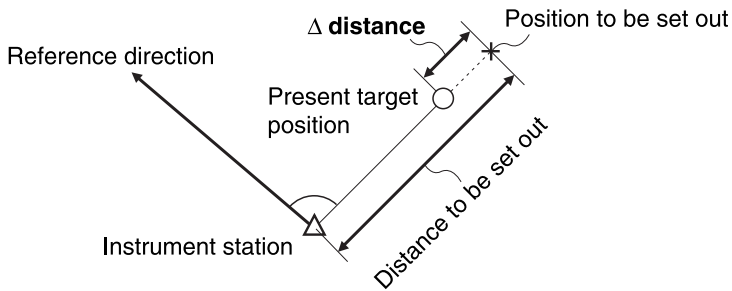

PROCEDURE

1. Select "Setting out" in <Menu> to display <Setting out>.

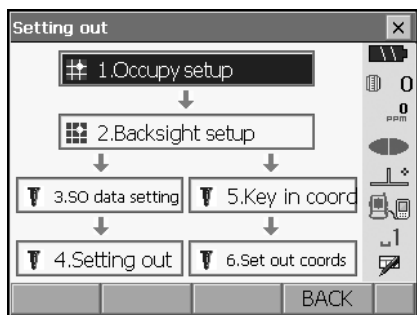
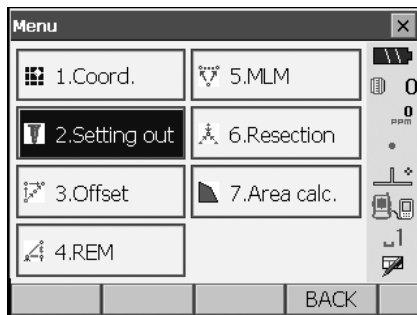

2. Select "Occupy setup" to display <Occupy setup>. Enter data for the instrument station and press [OK] to move to Backsight setup.  
 "14.1 Entering Instrument Station Data"

Reference Direction



Instrument station

3. Set the azimuth angle for the backsight station. Press [OK] to return to <Setting out>.  
 "14.2 Azimuth Angle Setting"

- Select "SO data setting" In <Setting out> to display <SO data setting>. In the distance mode that conforms to your measurement requirements, enter the included angle between the reference point and the setting-out point in "SO.H.ang", and the distance (slope distance, horizontal distance or height difference) from the instrument station to the position to be set out in "SO.Sdist".

- Each time **[Shvr]** is pressed, the distance mode changes from "SD" (slope distance), "HD" (horizontal distance), "VD" (height difference), and "Ht." (REM).
- Press **[COORD]** in the second page and input coordinates in <Key in coord>. The angle and distance from these coordinates to the position to be set out will be calculated.

- Enter values and press **[OK]** to display the screen at right.

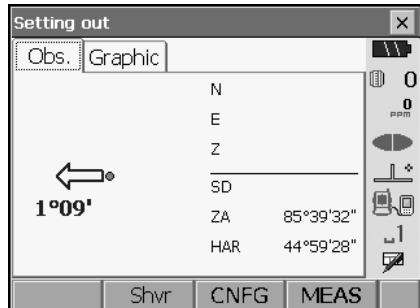
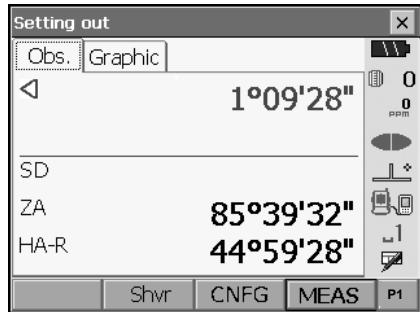
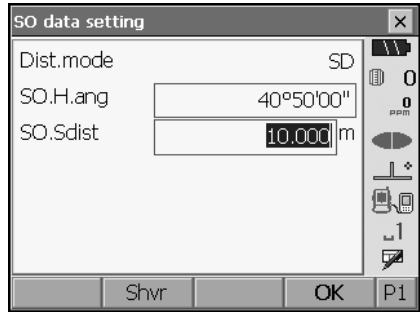





7. Move the target until the distance to the setting-out point reads 0m. When the target is moved within the allowed range, all distance and position arrows are displayed.

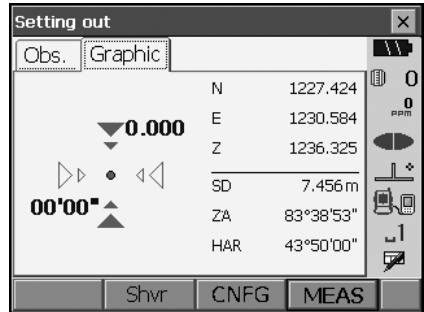
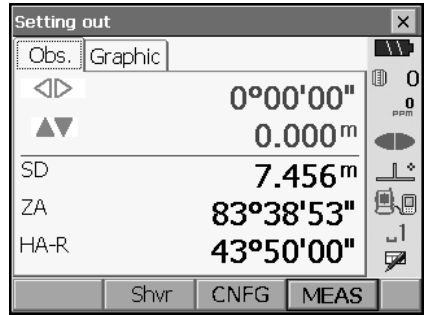

8. Press **{ESC}** to return to <Setting out>. Set the next setting out point to continue setting out measurement.

## 16.3 Coordinates Setting-out Measurement

After setting the coordinates for the point to be set out, the FX calculates the setting-out horizontal angle and horizontal distance. By selecting the horizontal angle and then the horizontal distance setting-out functions, the required coordinate location can be set out.

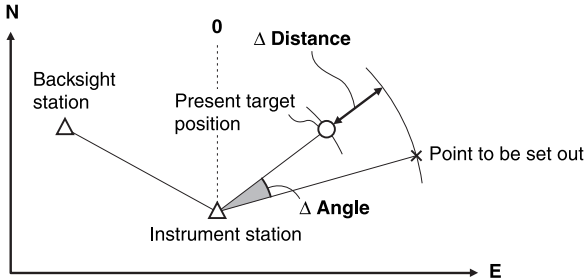

- Previously recorded setting-out points can be placed in order. Up to 50 points can be recorded.
- To find the Z coordinate, attach the target to a pole etc. with the same target height.

### PROCEDURE

1. Select "Setting out" in <Menu> to display <Setting out>.

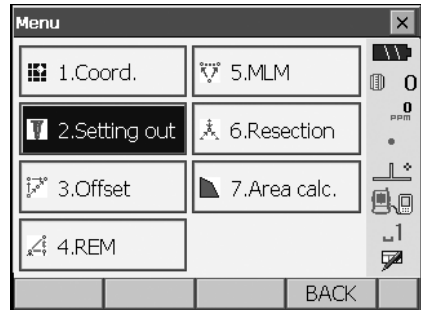

2. Select "Occupy setup" to display <Occupy setup>. If necessary, enter data for Backsight setup.
  - ☞ "16.2 Distance Setting-out Measurement" steps 2 to 3

3. Select "Key in coord" in <Setting out>. Record all the setting-out points (includes setting-out points you will measure from now).

Press **[ADD]** to record new data.

- Press **[DEL]** in the second page to delete the selected setting out point.
- Press **[DELALL]** in the second page to delete all setting out points.

The screenshot shows the 'Key in coord' window with a list of points and a table of values. The 'Pt.id' field is highlighted with 'Pt\_01'. The table shows values for N, E, Z, SD, ZA, and HAR.

Pt.id	Graphic		
Pt_01	N	1245.817	
	E	1233.844	
	Z	1234.512	
	SD	11.859m	
	ZA	94°46'44"	
	HAR	197°56'21"	

Buttons at the bottom: ADD, OK, P1

The screenshot shows the 'Key in coord' window with a form for entering coordinates. The 'Pt.id' field is highlighted with 'PT.01'. The form has fields for North, East, and Elev. with values of 0.000.

Pt.id	PT.01
North	0.000
East	0.000
Elev.	0.000

Buttons at the bottom: OK, P1

4. Select a setting-out point in the first screen of step 3 and press **[OK]** to display <Set out Coords>.

## 16. SETTING-OUT MEASUREMENT

5. Position the target on the line of sight and press **[MEAS]** to begin distance measurement.

The distance and direction to move the target until the setting out point is located is displayed on the FX. The sighting point measurement results (currently installed position of the target) are displayed.

- Switch between the tabs to display different sets of information.

The Graph 1 tab shows the current position of the mirror and the direction to the setting out point from this position.

The Graph 2 tab shows the position of the setting out point (square) and the current location of the mirror (circle).

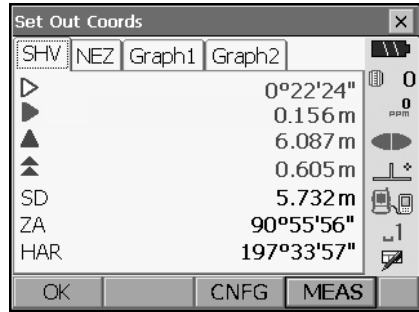

Height difference direction

Position of poleman

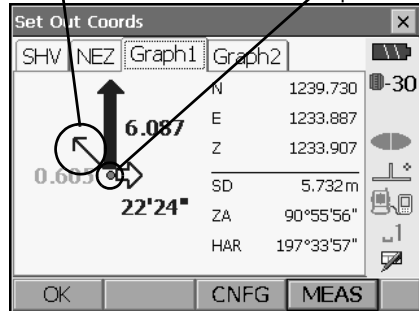

Move the target to find the correct distance (0 is displayed) to the setting out point.

- Movement indicators: "16.2 Distance Setting-out Measurement" step 6

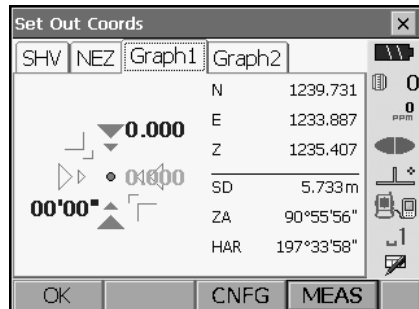
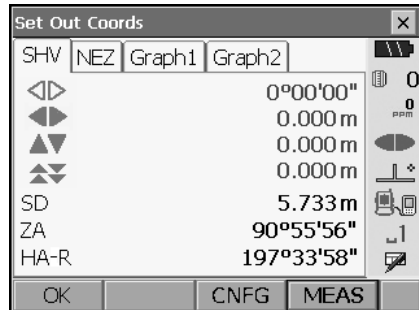

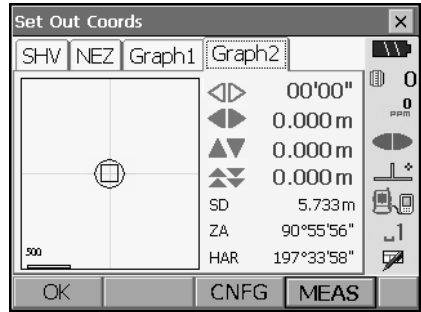

- Press **{ESC}** to return to <Key in coord>. Set the next setting out point to continue setting out measurement.

## 16.4 REM Setting-out Measurement

To find a point where a target cannot be directly installed, perform REM setting-out measurement.  
 "13.4 REM Measurement"

### PROCEDURE

- Install a target directly below or directly above the point to be found. Then use a measuring tape etc. to measure the target height (height from the surveying point to the target).
- Select "Occupy setup" in <Setting out> to display <Occupy setup>. If necessary, enter data for Backsight setup.  
 "16.2 Distance Setting-out Measurement" steps 2 to 3
- Select "SO data setting" In <Setting out> to display <SO data setting>. Press **[Shvr]** until the distance input mode is "SO.Height.". Input height from the surveying point to the position to be set out in "SO.Height". If necessary, input the angle to the point to be set out.

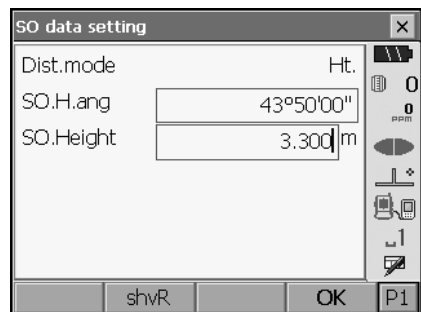

## 16. SETTING-OUT MEASUREMENT

4. Enter values and press **[OK]** in step 3 to display the screen at right.

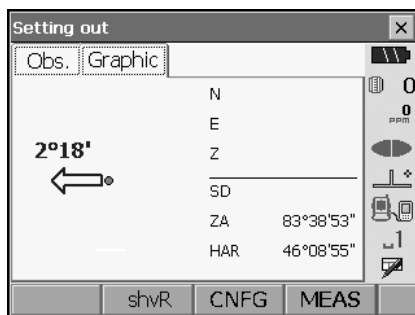

5. Sight the target and press **[MEAS]**. Measurement begins and the measurement results are displayed.

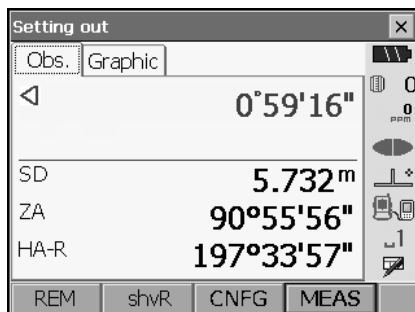

6. Press **[REM]** to start REM measurement. The distance (height difference) and direction to move the target until the sighting point and setting out point are located is displayed on the FX.

Arrows indicate direction to move

Press **[STOP]** to stop measuring.

Find the setting-out point by moving the telescope until the distance to the setting-out point reads 0m.

- Movement indicator (Red indicates that target position is correct)

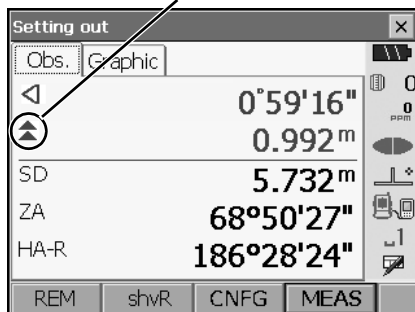

- ▲▲ : Move the telescope near the zenith
- ▼▼ : Move the telescope near the nadir
- ▲▼▲ : Telescope direction is correct

For details of other movement indicators:  
"16.2 Distance Setting-out Measurement"  
step 6

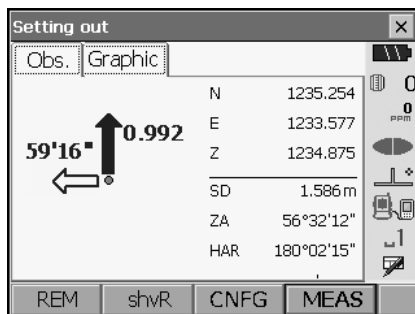

- Press **[CNFG]** to set setting out accuracy. When the position of the target is within this range both arrows will be displayed to indicate that the target position is correct.

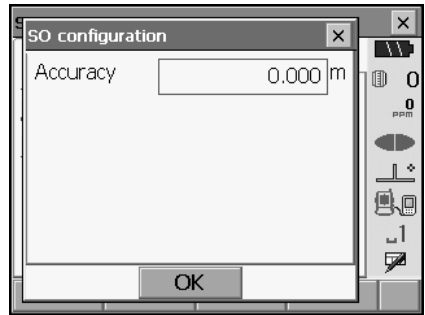

7. Press **{ESC}** to return to <SO data setting>.

# 17.OFFSET MEASUREMENT

Offset measurements are performed in order to find a point where a target cannot be installed directly or to find the distance and angle to a point which cannot be sighted.

- It is possible to find the distance and angle to a point you wish to measure (target point) by installing the target at a location (offset point) a little distance from the target point and measuring the distance and angle from the survey point to the offset point.
- The target point can be found in the three ways explained in this chapter.
- The instrument station and backsight must be set before the coordinates of an offset point can be found. Station and backsight setup can be performed in the Offset menu.
  - ☞ Occupy setup: "14.1 Entering Instrument Station Data", Backsight setup: "14.2 Azimuth Angle Setting" .
- It is possible to allocate softkeys in measurement menus to suit various applications and the ways that different operators handle the instrument.
  - ☞ "20.6 Allocating Key Functions"

## 17.1 Single-distance Offset Measurement

Finding it by entering the horizontal distance from the target point to the offset point.

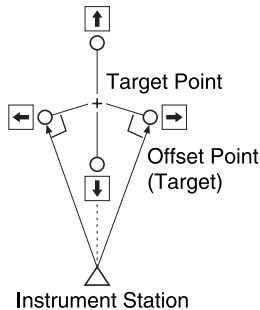

- When the offset point is positioned to the left or right of the target point, make sure the angle formed by lines connecting the offset point to the target point and to the instrument station is almost  $90^\circ$ .
- When the offset point is positioned in front of or behind the target point, install the offset point on a line linking the instrument station with the target point.

### PROCEDURE

1. Set the offset point close to the target point and measure the distance between them, then set up a prism on the offset point.



2. Select "Offset" in <Menu> to display .

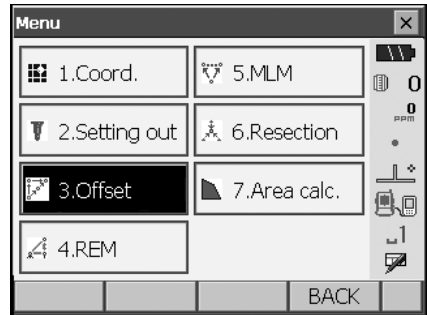

3. Select "Occupy setup" to display <Occupy setup>. Enter data for the instrument station and press [OK] to move to Backsight setup.  
 [F] "14.1 Entering Instrument Station Data"

Reference Direction



Instrument station

4. Set the azimuth angle for the backsight station. Press [OK] to return to <Offset>.  
 [F] "14.2 Azimuth Angle Setting"

5. Select "OffsetDIST".

Input the following items.

- (1) Direction of the offset point.
- (2) Horizontal distance from the target point to the offset point.

• Direction of offset point

- ← : On the left of the target point.
- : On the right of the target point.
- ↓ : Closer than the target point.
- ↑ : Beyond the target point.

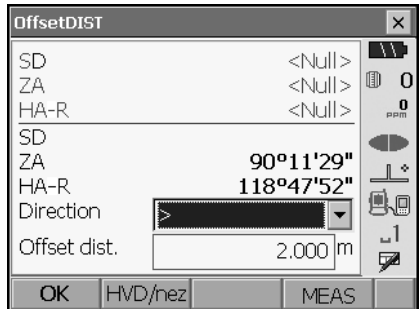
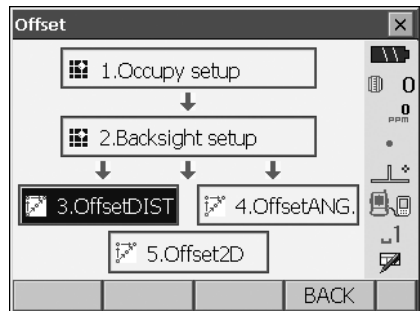

## 17. OFFSET MEASUREMENT

- Sight the offset point and press **[MEAS]** in the screen of step 3 to start measurement.  
Press **[STOP]** to stop the measurement.  
The measurement results are displayed.
- Press **[HVD/nez]** to switch results for the target point between distance/angle values and coordinate/elevation values.

OffsetDIST		0
SD	5.734 m	0 ppm
ZA	90°11'21"	
HA-R	140°51'37"	
SD		5.374 m
ZA		90°11'59"
HA-R		161°16'20"
Direction		>
Offset dist.		2.000 m
OK	HVD/nez	MEAS

## 17.2 Angle Offset Measurement

Sighting the direction of the target point to find it from the included angle.  
Install offset points for the target point on the right and left sides of and as close as possible to the target point and measure the distance to the offset points and the horizontal angle of the target point.

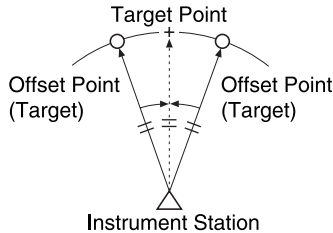

### PROCEDURE

1. Set the offset points close to the target point (making sure the distance from the instrument station to the target point and the height of the offset points and the target point are the same), then use the offset points as the target.

2. Select "Offset" in <Menu> to display <Offset>.

Select "OffsetANG".

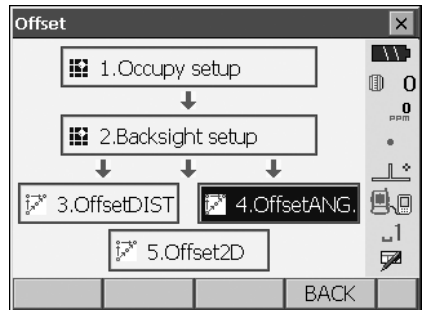

## 17. OFFSET MEASUREMENT

- Sight the offset point and press **[MEAS]** to start measurement.  
Press **[STOP]** to stop the measurement.

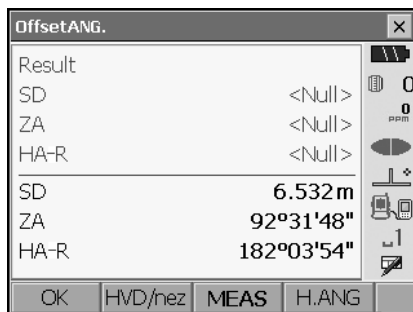

- Sight the target point and press **[H.ANG.]**.
  - Press **[HVD/nez]** to switch results for the target point between distance/angle values and coordinate/elevation values.

Results for offset point

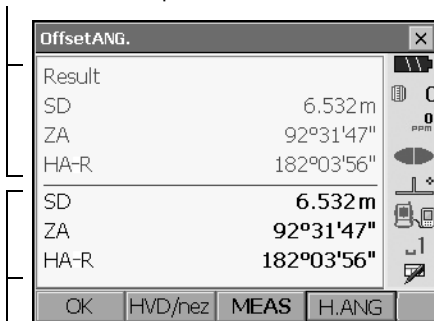

Results for target point

- Press **[OK]** in the screen in step 4 to return to <Offset>.

## 17.3 Two-distance Offset Measurement

By measuring the distances between the target point and the two offset points.

Install two offset points (1st target and 2nd target) on a straight line from the target point, observe the 1st target and 2nd target, then enter the distance between the 2nd target and the target point to find the target point.

- It is possible to make this measurement easily using the optional equipment: the 2-point target (2RT500-K). When using this 2-point target, be sure to set prism constant to 0.

 "24. TARGET SYSTEM"

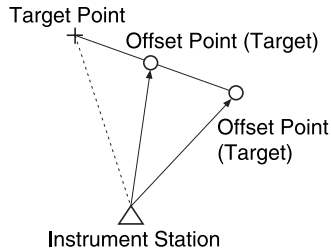

How to use 2-point target (2RT500-K)

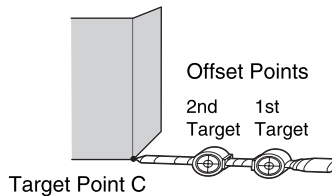

- Install the 2-point target with its tip at the target point.
- Face the targets toward the instrument.
- Measure the distance from the target point to the 2nd target.
- Set the prism constant to 0mm.

### PROCEDURE

1. Install two offset points (1st target, 2nd target) on a straight line from the target point and use the offset points as the target.

2. Select "Offset" in <Menu> to display <Offset>.

Select "5.Offset2D".

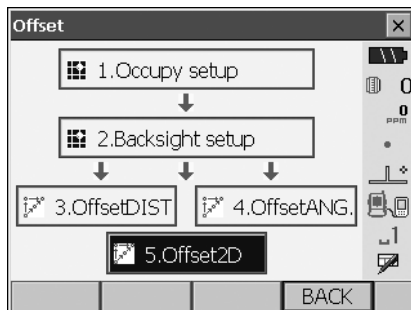

3. Press **[CNFG]** and input the distance from the 2nd target to the target point in "Offset dist.". Set reflector settings and press **[OK]** to confirm.

- Press **[LIST]** to edit the prism constant and aperture in <Reflector setting>.

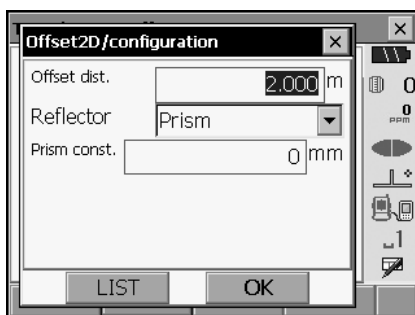

4. Sight the 1st target and press **[MEAS]** to start measurement.  
Press **[STOP]** to stop the measurement. The measurement results are displayed. Press **[YES]** to confirm.



5. Sight the 2nd target and press **[MEAS]** to start measurement.  
Press **[STOP]** to stop the measurement. The measurement results are displayed.

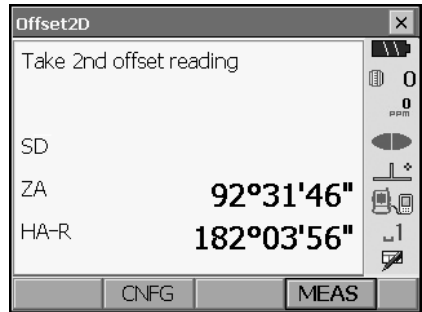

6. Press **[YES]** to display results for the target point.

Press **[HVD/nez]** to switch results for the target point between distance/angle values and coordinate/elevation values.

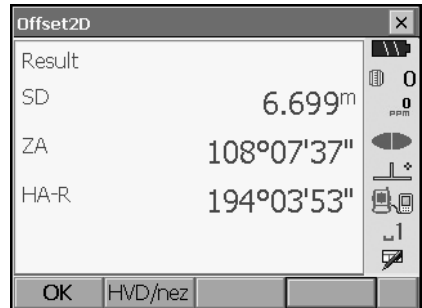

# 18.MISSING LINE MEASUREMENT

Missing line measurement is used to measure the slope distance, horizontal distance, and horizontal angle to a target from the target which is the reference (starting point) without moving the instrument.

- It is possible to change the last measured point to the next starting position.
- Measurement results can be displayed as the gradient between two points.

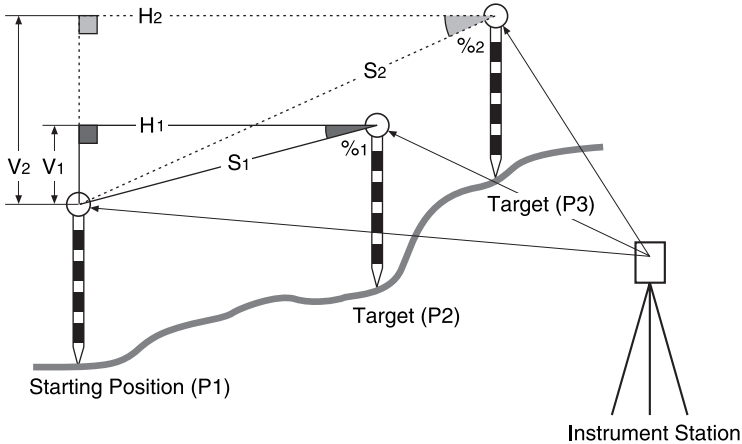

- It is possible to allocate softkeys in measurement menus to suit various applications and the ways that different operators handle the instrument.  
☞ "20.6 Allocating Key Functions"

## 18.1 Measuring the Distance between 2 or more Points

### PROCEDURE

1. Select "MLM" in <Menu>.

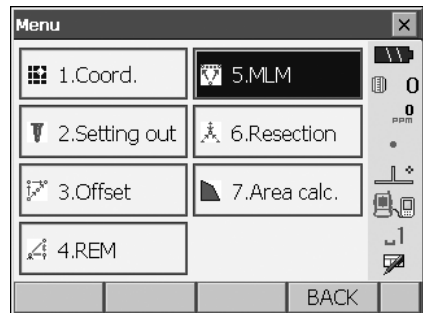



- Sight the starting position, and press **[MEAS]** to start measurement.  
Press **[STOP]** to stop measurement.

**Note**

- When measurement data already exists the screen of step 3 is displayed and measurement starts.

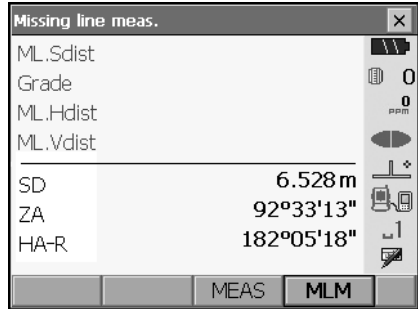
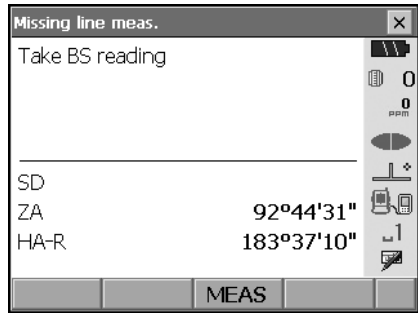

- Sight the next target and press **[MLM]** to begin observation. Slope distance, grade, horizontal distance and height difference between multiple points and the starting position can be measured this way.

- Press **[MEAS]** to re-observe the starting position. Sight the starting position and press **[MEAS]**.
- When **[MOVE]** is pressed, the last target measured becomes the new starting position to perform missing line measurement of the next target.

"18.2 Changing the Starting Point"

Results for measurement between starting position and second target

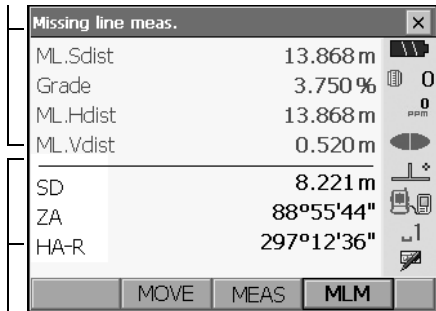

Results for current point

- Press **{ESC}** or tap the cross in the top-right corner to end missing line measurement.

## 18.2 Changing the Starting Point

It is possible to change the last measured point to the next starting position.

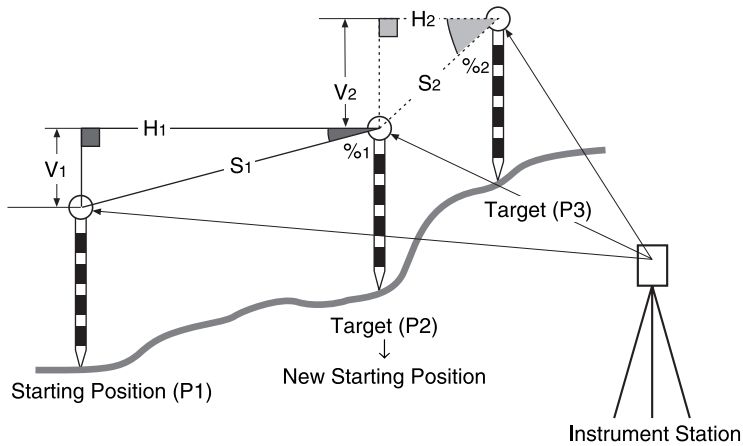

### PROCEDURE

1. Observe the starting position and target following steps 1 to 3 in "18.1 Measuring the Distance between 2 or more Points".
2. After measuring the targets, press **[MOVE]**.

Missing line meas.	
ML.Sdist	13.868 m
Grade	3.750 %
ML.Hdist	13.868 m
ML.Vdist	0.520 m
<hr/>	
SD	8.221 m
ZA	88°55'44"
HA-R	297°12'36"
<span>MOVE</span> <span>MEAS</span> <span>MLM</span>	

Press **[YES]** in the confirmation message window.

- Press **[NO]** to cancel measurement.

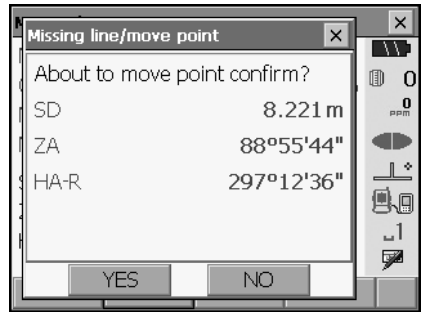



3. The last target measured is changed to the new starting position.
4. Perform missing line measurement following steps 3 to 4 in "18.1 Measuring the Distance between 2 or more Points".

# 19.SURFACE AREA CALCULATION

You can calculate the area of land (slope area and horizontal area) enclosed by three or more known points on a line by inputting the coordinates of the points

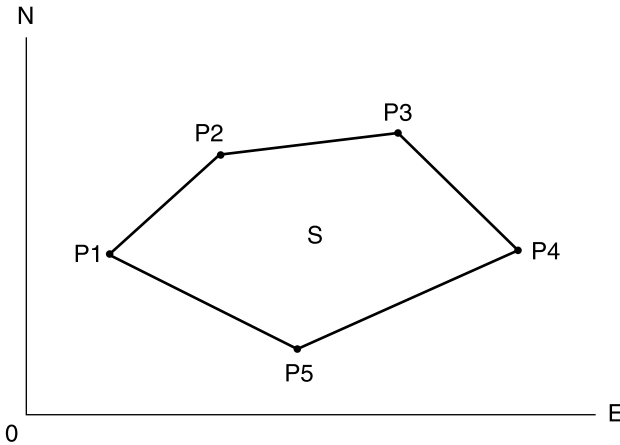
Input		Output
Coordinates:	P1 (N1, E1, Z1)	Surface area: S (horizontal area and slope area)
	...	
	P5 (N5, E5, Z5)	



- Number of specified coordinate points: 3 or more, 30 or less
- Surface area is calculated by observing in order the points on a line enclosing an area or by reading in the previously registered coordinates and using it as known point data.
- It is possible to allocate softkeys in measurement menus to suit various applications and the ways that different operators handle the instrument.  
 "20.6 Allocating Key Functions"



- An error will occur if only two points (or less) are entered (or recalled) when specifying an enclosed area.
- Be sure to observe (or recall) points on an enclosed area in a clockwise or counterclockwise direction. For example, the area specified by entering (or recalling) point numbers 1, 2, 3, 4, 5 or 5, 4, 3, 2, 1 implies the same shape. However, if points are not entered in numerical order, the surface area will not be calculated correctly.



## Slope area

The first three points specified (measured/read-in) are used to create the surface of the slope area. Subsequent points are projected vertically onto this surface and the slope area calculated.

## PROCEDURE Surface area calculation by measuring points

1. Select "Area calc." in <Menu>

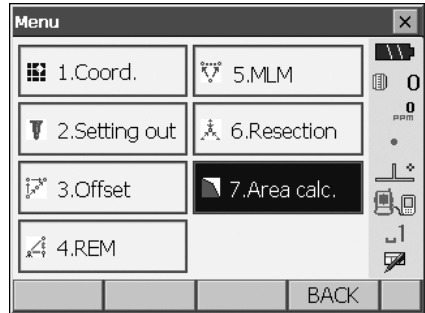

2. Press **[OBS]** to display <Area calculation/ measurement>. Sight the first point on the line enclosing the area, and press **[MEAS]**. Measurement begins and the measured values are displayed. Press **[STOP]** to stop measuring.

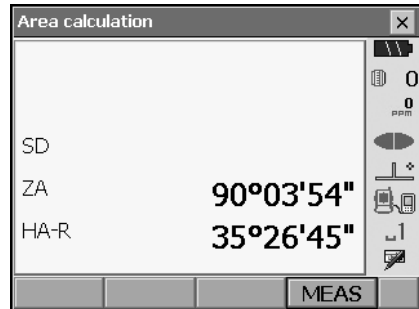
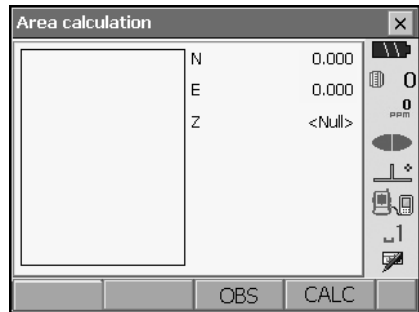

## 19. SURFACE AREA CALCULATION

3. The measurement results are displayed. Press **[YES]** to confirm. The value of point 1 is set in "Pt\_01".

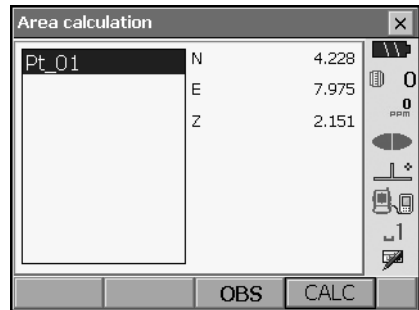
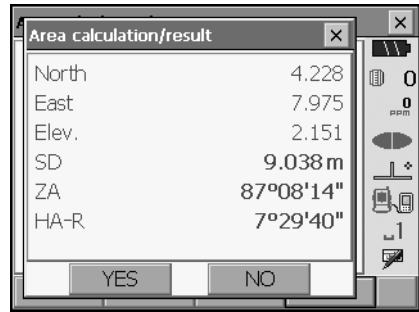

4. Repeat steps 2 to 3 until all points have been measured. Points on an enclosed area are observed in a clockwise or counterclockwise direction. For example, the area specified by entering point numbers 1, 2, 3, 4, 5 or 5, 4, 3, 2, 1 implies the same shape.

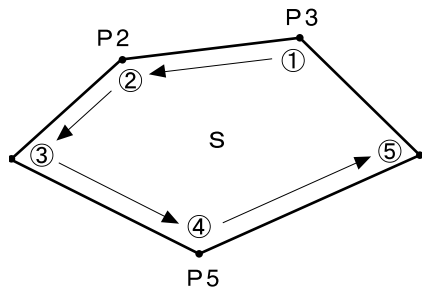

5. Press **[CALC]** to display the calculated area.

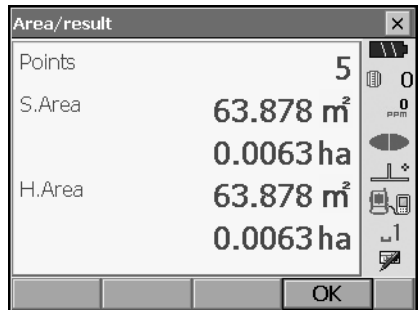
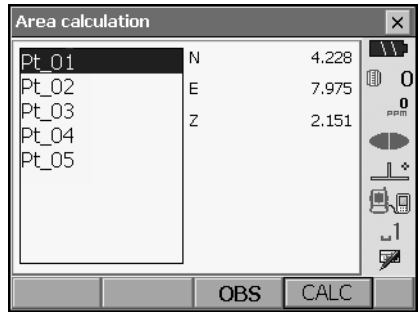

6. Press **[OK]** to return to <Area/key in coord.>. Press **{ESC}** or tap the cross in the top-right corner to quit area calculation.

# 20.CHANGING THE SETTINGS

This section explains the contents of parameter settings in Basic mode and how to change these settings.

Each item can be changed to meet your measurement requirements.

<Configuration> can be accessed by pressing the "CONFIG" icon in <Top>.

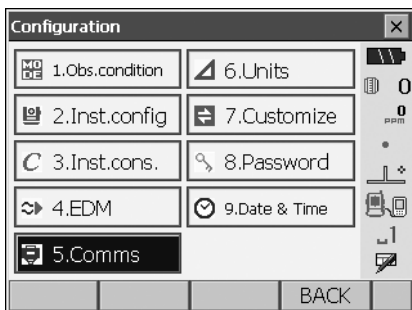

The following chapters provide details of items in Configuration mode.

- Communication settings "10. CONNECTING TO EXTERNAL DEVICES"
- Instrument configurations "22.2 Tilt Sensor", "22.4 Reticle"

## 20.1 Observation Conditions

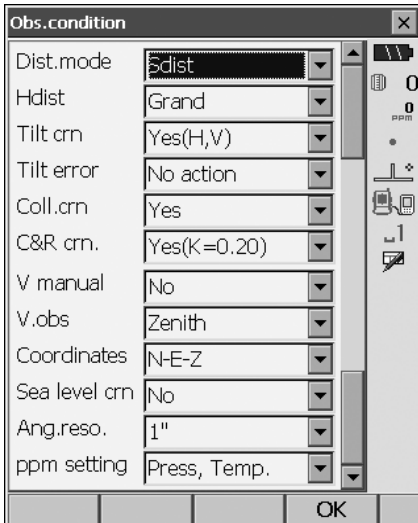





### Items set and options (\*: Factory setting)

Distance mode: Sdist (slope distance)\*, Hdist (horizontal distance), V.dist (height difference)

Hdist : Grand\*, Grid



Tilt crn (tilt correction) 	Yes (H,V)*, No, Yes (V)
Tilt error:	No action*/Go to Tilt screen
Coll.crn. (collimation correction) 	No, Yes*
C&R crn.:	No, Yes(K=0.142),Yes(K=0.20)*
V manual:	No*, Yes
V.obs (vertical angle display method) 	Zenith*, Horiz., Horiz ±90
Coordinates:	N-E-Z*, E-N-Z
Sea level crn. (Sea level correction) 	Yes, No*
Ang.reso. (Angle resolution):	FX-101/FX-102: 0.5", 1"* FX-103/FX-105/FX-107: 1"*, 5"
ppm setting:	Press, Temp.*, +Humidity



**Hdist**

The FX calculates horizontal distance using slope distance values. Horizontal distance display can be selected from the following methods.

- Grand: Distance without sea level correction
- Grid: Distance on the rectangular coordinates system calculated by sea level correction  
(When "Sea level crn." is set to "No", Distance on the rectangular coordinates system without correction)

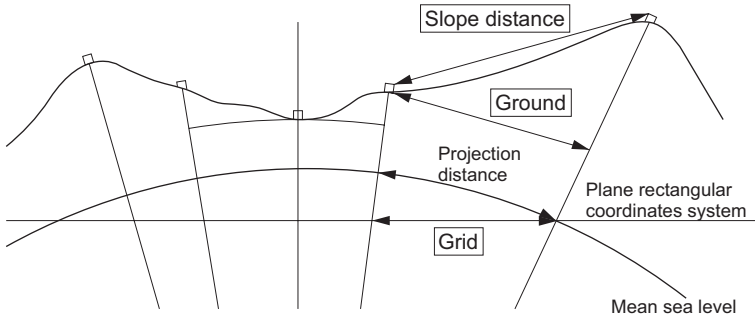

**Automatic tilt angle compensation mechanism**

The vertical and horizontal angles are automatically compensated for small tilt errors using the 2-axis tilt sensor.

- Read the automatically compensated angles when the display has stabilized.
- The horizontal angle error (vertical axis error) fluctuates according to the vertical axis, so when the instrument is not completely leveled, changing the vertical angle by rotating the telescope will cause the displayed horizontal angle value to change.
- Compensated horizontal angle = Measured horizontal angle + Tilt in angle/tan (Vertical angle)
- When the telescope is directed close to the zenith or nadir angle, tilt compensation is not applied to the horizontal angle.

## 20. CHANGING THE SETTINGS

---



### Collimation correction

The FX has a collimation correction function that automatically corrects horizontal angle errors caused by horizontal axis and leveling axis errors.



### Sea level correction

The FX calculates horizontal distance using slope distance values. As this horizontal distance does not take height above sea level into consideration, performing spherical correction is recommended when measuring at high altitudes. Spherical distance is calculated as follows.

Spherical distance

$$= \frac{R - H_a}{R} \times d_1$$

Where: R = radius of the spheroid (6372.000m)

$H_a$  = averaged elevation of the instrument point and target point

$d_1$  = horizontal distance



### V mode (vertical angle display method)

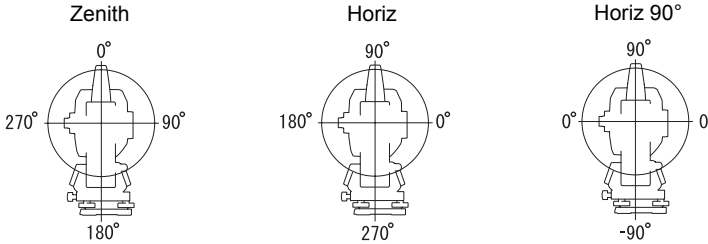

## 20.2 Instrument Configuration

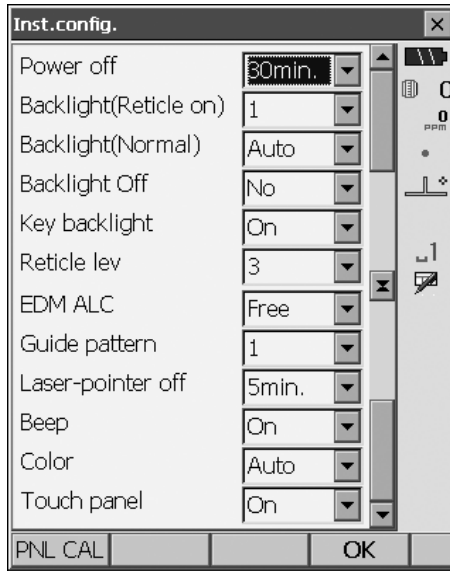

### Items set and options (\*: Factory setting)

Power off	No/5min./10min./15min./30min.*
Backlight (Reticle On)	0 to 8 (1*) (Brightness level on pressing )
Backlight (Normal)	0 to 8 / Auto (Auto*)
Backlight Off	No*/30sec/1min./5min./10min.
Key backlight	Off/On*
Reticle lev	0 to 5 level (3*)
EDM ALC	Free*/Hold
Guide pattern:	1* (simultaneous)/2 (alternating)
Laser-pointer off	No/1min./5min.*/10min./30min.
Beep:	On*/Off
Color:	1/2 (monochrome) / Auto (Auto*)
Touch panel:	On (fixed)

### Note

- Press **[PNL CAL]** to display the touch panel calibration screen.  
 "9.1 Configuring the Touch Panel"



### Adjusting backlight brightness/turning the reticle illumination and key backlight ON/OFF

Pressing switches the brightness level of the backlight in conjunction with the ON/OFF status of the reticle illumination/key backlight.

When the FX is powered ON the brightness level is set to "Backlight (Normal)". "Backlight (Normal)" was set to a higher brightness level than "Backlight (Reticle ON)" when the FX was shipped but these values can be modified according to user preferences.

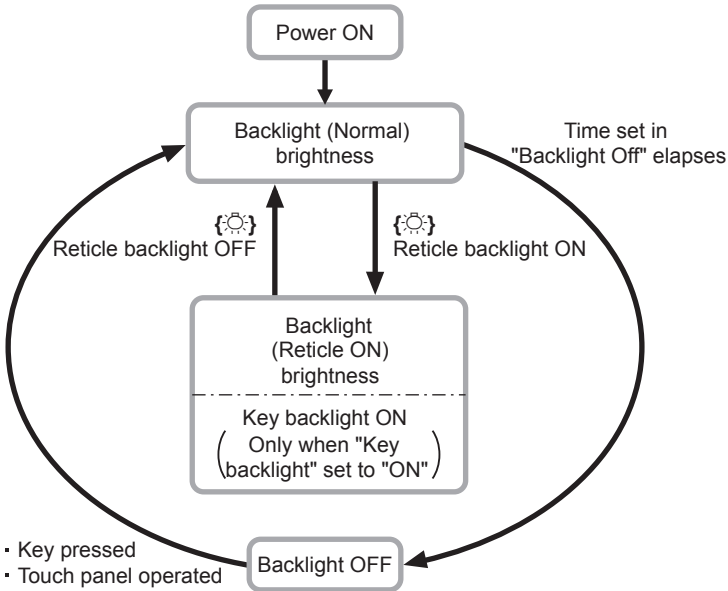

### Power-saving automatic cut-off/Backlight Off

To save power, power to the FX is automatically cut off if it is not operated for the set time.

The backlight will similarly be turned off if the instrument is not operated for the selected time. However, the backlight will not be turned off when "Backlight" is set to "ON".



### EDM ALC

Set the light receiving status of the EDM. While carrying out continuous measurement, set this item according to the measurement conditions.

- When EDM ALC is set to "Free," the instrument's ALC will be automatically adjusted if an error occurs as a result of the amount of light received. Set to "Free" when the target is moved during measurement or different targets are used.
- When "Hold" is set, the amount of light received will not be adjusted until continuous measurement is completed.
- If an obstacle intermittently obstructs the light beam during continuous measurement and the "Signal off" error occurs, each time the obstruction occurs it takes some time for the amount of light received to be adjusted and the measurement value displayed. Set to "Hold" when the light beam used for measurement is stable but is frequently obstructed by obstacles such as people, cars, or tree branches etc. preventing measurement from being performed.



- When the distance measurement mode is set to "Tracking" (target is moved during distance measurement) the EDM ALC will be adjusted regardless of the EDM ALC setting.

**Laser-pointer off**

To save power, the laser-pointer is automatically turned off after the set time has elapsed.

**Key backlight**

The key backlight can be set to "ON" or "OFF". When "ON" the keys will be illuminated when "Backlight (Bright)" is active.

## 20.3 EDM Settings

- "EDM" tab

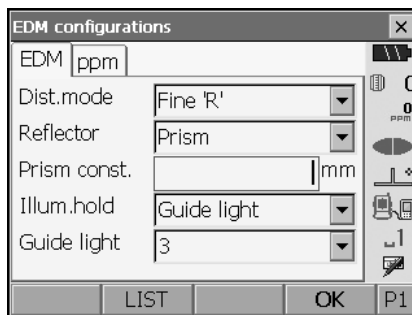

### Items set, options, and input range (\*: Factory setting)

Dist. mode (Distance measurement mode):	Fine "R"*, Fine AVG n= 1(Setting: 1 to 9 times), Fine "S", Rapid "R", Rapid "S", Tracking
Reflector:	Prism*/Sheet/N-Prism
Prism constant:	-99 to 99 mm ("Prism" is selected: 0*, "Sheet" is selected: 0)
Illum. hold (f: function):	Laser-pointer*/Guide light
Guide light (Bright):	1 to 3 (3*)

- The setting for "Fine AVG" distance measurement mode can be increased/decreased using the [ + ]/[ - ] softkeys.
- Target information can be edited and recorded.  
 "PROCEDURE Recording and editing target information"
- "Prism constant" will not be displayed when "N-Prism" is selected in "Reflector".
- When "prism constant" values are changed and [OK] is pressed, these changes are reflected in the status bar target type display temporarily. This display will also change to reflect changes in target information settings made using a data collector temporarily. In both of the above cases, changes will not be recorded in <Reflector setting>.  
 Status bar: "5.2 Display Functions", <Reflector setting>: "PROCEDURE Recording and editing target information", Cold boot: "9.2 Resolving Software Issues D Cold boot"
- The Guide light brightness item ("Guide light (Bright)") will be displayed only when "Illum. hold" is set to "Guide light".



### Prism constant correction

Reflective prisms each have their prism constant.

Set the prism constant correction value of the reflective prism you are using. When selecting "N-Prism" in "Reflector", prism constant correction value is set to "0" automatically.

### ● "ppm" tab

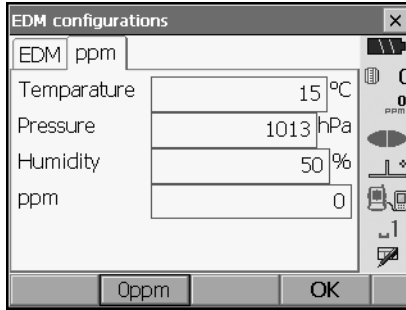

- **[Oppm]**: Atmospheric correction factor returns to 0 and temperature and air pressure are set to the factory settings.
- Atmospheric correction factor is calculated and set using the entered values of the temperature and air pressure. Atmospheric correction factor can also be entered directly.
- When the settings here are different between basic mode and program mode, program mode settings are prior for use.

### Items set, options, and input range (\*: Factory setting)

- |                                      |                                                                                  |
|--------------------------------------|----------------------------------------------------------------------------------|
| Temperature:                         | -30 to 60°C (15*), -22 to +140°F (59*)                                           |
| Pressure:                            | 500 to 1400hPa (1013*), 375 to 1050mmHg (760*),<br>14.8 to 41.3 (inchHg) (29.9*) |
| Humidity:                            | 0 to 100% (50*)                                                                  |
| ppm (Atmospheric correction factor): | -499 to 499 (0*)                                                                 |
- The "Humidity" item is displayed only when the "ppm setting" in "Obs. condition" is set to "+Humidity".



### Atmospheric correction factor

The velocity of the light beam used for measurement varies according atmospheric conditions such as temperature and air pressure. Set the atmospheric correction factor when you wish to take this influence into account when measuring.

- The FX is designed so that the correction factor is 0 ppm at an air pressure of 1013 hPa, a temperature of 15°C, and a humidity of 50%.
- By inputting the temperature, air pressure values and humidity, the atmospheric correction value is calculated using the following formula and set into the memory.

Atmospheric Correction Factor (ppm) =

$$282.324 - \frac{0.294362 \times p}{1 + 0.003661 \times t} + \frac{0.04127 \times e}{1 + 0.003661 \times t}$$

t : Air temperature (°C)

p : Pressure (hPa)

e : Water vapor pressure (hPa)

h : Relative humidity (%)

E : Saturated water vapor pressure

- e (water vapor pressure) can be calculated using the following formula.

$$e = h \times \frac{E}{100} \quad \frac{(7.5 \times t)}{(t + 237.3)}$$

$$E = 6.11 \times 10^{\frac{(7.5 \times t)}{(t + 237.3)}}$$

- The FX measures the distance with a beam of light, but the velocity of this light varies according to the index of refraction of light in the atmosphere. This index of refraction varies according to the temperature and pressure. Near normal temperature and pressure conditions:

With constant pressure, a temperature change of 1°C: an index change of 1 ppm.

With constant temperature, a pressure change of 3.6 hPa: an index change of 1 ppm.

To perform high accuracy measurements, it is necessary to find the atmospheric correction factor from even more accurate temperature and pressure measurements and perform an atmospheric correction.

It is recommended that extremely precise instruments be used to monitor the air temperature and pressure.

- Enter the average temperature, air pressure and humidity along the measurement beam route in "Temperature", "Pressure" and "Humidity".

Flat terrain: Use the temperature, pressure and humidity at the midpoint of the line.

Mountainous terrain: Use the temperature, pressure and humidity at the intermediate point (C).

If it is not possible to measure the temperature, pressure and humidity at the midpoint, take such measurements at the instrument station (A) and the target station (B), then calculate the average value.

Average air temperature:  $(t_1 + t_2)/2$

Average air pressure:  $(p_1 + p_2)/2$

Average humidity:  $(h_1 + h_2)/2$

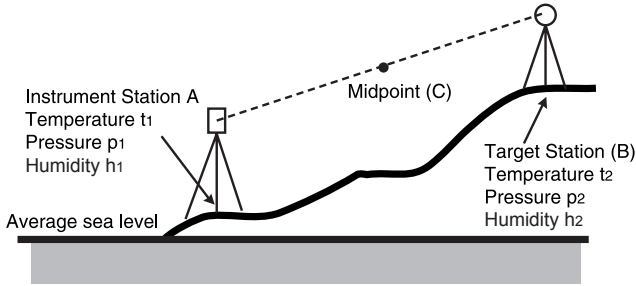

- If the weather correction is not required, set the ppm value to 0.

### PROCEDURE Recording and editing target information

The **[LIST]** softkey is displayed when either "Reflector" or "Prism const." is selected in the "EDM" tab of <EDM configurations>.

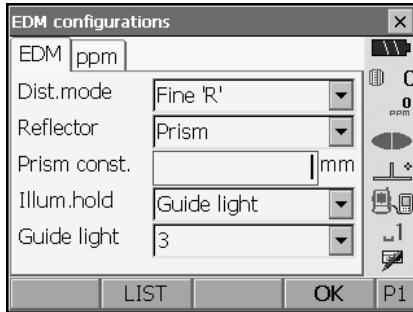

1. Press **[LIST]** to display a list of all recorded targets.

- **[ADD]**: Displays <Reflector list>. Select the desired target from this list and press **[OK]** to register in the list in <Reflector setting>. Up to a maximum of 6 targets can be recorded.
- **[DEL]**: Deletes the selected target.

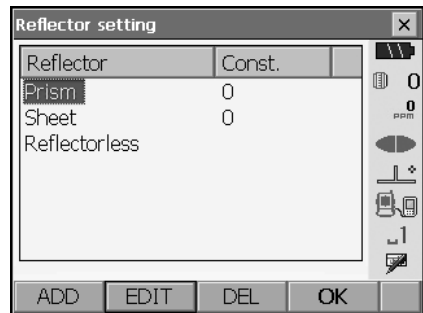



- To edit a target, select the desired target and press **[EDIT]**. <Reflector/edit> is displayed. Select/input relevant information for the target.

Reflector: Prism/Sheet/N-Prism  
 Const.: -99 to 99 mm

- When selecting "N-Prism" in "Reflector", prism constant correction values are set to "0" automatically.

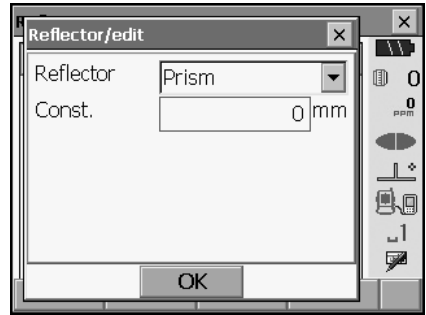

- Press **[OK]** in the screen of step 2 to save edited information and return to <Reflector setting>. Press **[OK]** to return to <EDM configurations>.

## 20.4 Allocating User-defined Tabs

It is possible to allocate tabs in Observation mode and Menu mode to suit the measurement conditions. It is possible to operate the FX efficiently because unique tab allocations can be preset to suit various applications and the ways that different operators handle the instrument.

- The current tab allocations are retained until they are revised again, even when the power is cut off.
- Press **[CLEAR]** in <Customize/Select screen> to return all customized configurations including screen controls, status bar settings, and softkey allocations to their previous settings.
- One screen can contain a maximum of 5 tabs.



- When tab allocations are recorded and registered, the previously recorded tab settings are cleared.

### ● Tab allocations

The following are tabs allocated when the FX was shipped and tabs that can be defined by the user.

- "Basic observation"

Factory settings	User-definable tabs
SHV	SHV
SHVdist	SHVdist
Graphic	SHV + Coord.

- Setting out

Factory settings	User-definable tabs
Obs.	Obs.
Graphic	

## 20. CHANGING THE SETTINGS

---

- Setting out Coord.

Factory settings	User-definable tabs
SHV	SHV
NEZ	NEZ
Graph1	
Graph2	



- Graphic tab cannot be deleted.

### PROCEDURE Allocating tabs

---

1. Select "Customize" to display <Customize/Select screen>.  
Select the measurement mode in which you want to allocate a tab.

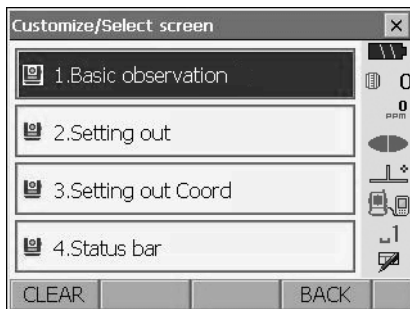

Select "Tab page".

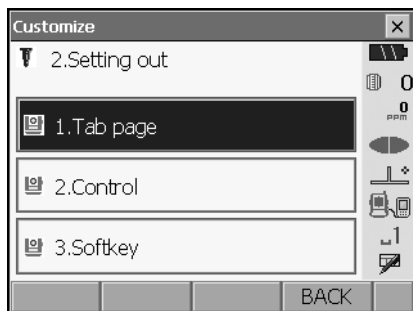

- Use the softkeys (**[ADD]**, **[DEL]** etc.) in <Customize tab page> to allocate the desired tab page layout.

- Press **[ADD]** to add the selected tab at the right-hand side of the screen.
- Press **[INS]** in the second page to insert the selected tab in front of the current tab.
- Press **[CNFG]** in the second page to replace the current tab with the selected tab.
- Press **[DEL]** to delete the current tab.

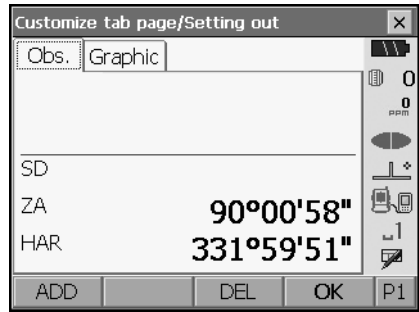

- Tabs, once deleted, cannot be retrieved.

Select a tab type from the "Type" drop-down list.



- Repeat step 2 to perform further tab allocations.
- Press **[OK]** to finish allocating tabs. The allocated tabs are stored in memory and <Customize> is displayed. The newly allocated tabs appear in the relevant measurement screen.

## 20.5 Customizing Screen Controls

It is possible to customize screen controls in Observation mode to suit the measurement conditions and the different methods employed by different operators.

- The current screen control settings are retained until they are revised again, even when the power is cut off.
- Press **[CLEAR]** in <Customize/Select screen> to return all customized configurations including tab pages, status bar settings, and softkey allocations to their previous settings.
- Screen controls cannot be set for the "Graphic" tab.



- When screen control settings are recorded and registered, the previously recorded settings are cleared.

## PROCEDURE Customizing screen controls

1. Select "Customize" to display <Customize/Select screen>. Select the measurement mode in which you want to customize screen controls.

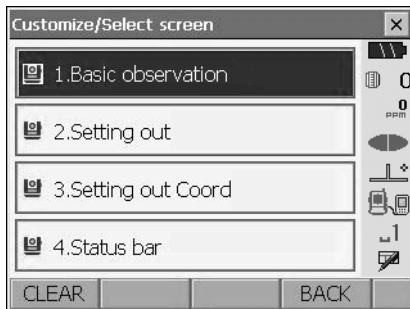

Select "Control".

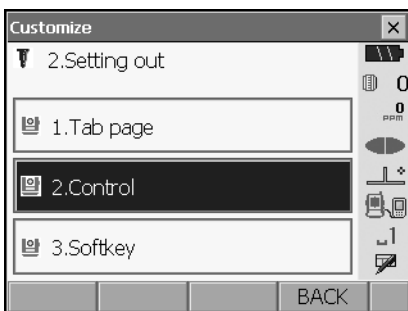

2. Press **[ADD]** to add a control drop-down list.
  - Press **[DEL]** to delete the selected control.



- Controls, once deleted, cannot be retrieved.

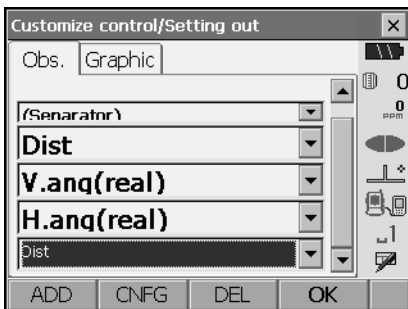

3. Select a screen control from the list.

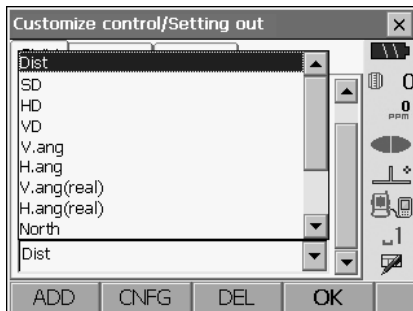

4. Press **[CNFG]** to set the size, thickness, color and spacing of the font.

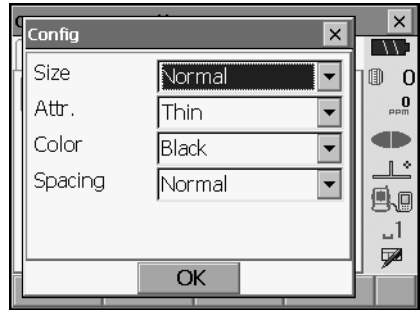

5. Repeat steps 2 to 4 to customize more screen controls.
6. Press **[OK]** to finish customizing screen controls. The modifications are stored in memory and <Customize> is displayed. The modifications are reflected in the relevant screens.

## 20.6 Allocating Key Functions

It is possible to allocate the softkeys in Observation mode to suit the measurement conditions. It is possible to operate the FX efficiently because unique softkey allocations can be preset to suit various applications and the ways that different operators handle the instrument.

- The current softkey allocations are retained until they are revised again, even when the FX is powered OFF.
- Press **[CLEAR]** in <Customize/Select screen> to return all customized configurations including tab pages, status bar settings, and screen controls to their previous settings.



- When softkey allocations are recorded and registered, the previously recorded key settings are cleared.
- Softkeys cannot be allocated to "Graphic" tabs.
- The following are the screens that can be customized and softkey allocations when the FX was shipped.
  1. "SHV" and "SHVdist" tabs of <Basic observation>
    - Page 1 **[EDM] [TILT] [OSET] [MEAS]**
    - Page 2 **[MENU] [OFFSET] [H-SET] [COORD]**
    - Page 3 **[MLM] [RESEC] [REM] [S-O]**
  2. "Obs." tab of <Setting out>
    - Page 1 **[REM] [SHVR] [CNFG] [MEAS]**
    - Page 2 **[ --- ] [ --- ] [ --- ] [ --- ]**
    - Page 3 **[ --- ] [ --- ] [ --- ] [ --- ]**

## 20. CHANGING THE SETTINGS

---

### 3. "SHV" and "NEZ" tabs of <Set out Coords>

Page 1 [ OK ] [ --- ] [CNFG] [MEAS]

Page 2 [ --- ] [ --- ] [ --- ] [ --- ]

Page 3 [ --- ] [ --- ] [ --- ] [ --- ]

#### ● The following functions can be allocated to the softkeys.

- [ --- ] : No functions set
- [MEAS] : Distance and angle measurement
- [CNFG] : Set setting out accuracy (can only be allocated to 2 and 3 above)
- [SHV] : Switch the "SHV" tab and "SHVdist" tab (can only be allocated to 1 above)
- [SHVR] : Switch distance mode between slope distance (SD)/horizontal distance (HD)/height difference (VD)/REM (R) in setting out screens. The capitalized letter in the softkey indicates the currently selected mode (can only be allocated to 2 above).
- [OK] : Terminate setting out measurement for the selected setting out point and return to <Key in coord>. This setting out point will be removed from the list (can only be allocated to 3 above).
- [0SET] : Set horizontal angle to 0°
- [H-SET] : Set required horizontal angle
- [R/L] : Select horizontal angle right/left. The capitalized letter in the softkey indicates the currently selected mode.
- [ZA / %] : Switch between zenith angle/slope in %. The capitalized letter in the softkey indicates the currently selected mode.
- [HOLD] : Hold horizontal angle/release horizontal angle
- [CALL] : Display final measurement data
- [HVOUT-T] : Output angle measurement results to an external device (can only be allocated to 1 above)
- [HVOUT-S] : Output angle measurement results to an external device
- [HVDOUT-T] : Output distance and angle measurement results to an external device (can only be allocated to 1 above)
- [HVDOUT-S] : Output distance and angle measurement results to an external device
- [NEZOUT-T] : Output coordinates data to an external device (can only be allocated to 1 above)
- [F/M] : Switch distance units between meters/feet
- [HT] : Set the instrument station, coordinates and instrument height
- [S-LEV] : Return signal
- [TILT] : Display tilt angle
- [EDM] : EDM settings
- [MENU] : Display <Menu> (coordinate measurement, setting out measurement, offset measurement, REM measurement, missing line measurement, resection, area calculation)
- [COORD] : Coordinates measurement
- [S-O] : Setting-out measurement
- [OFFSET] : Offset measurement
- [A-OFS] : Angle offset menu
- [D-OFS] : Distance offset menu
- [2D-OFS] : Offset/2D menu
- [MLM] : Missing line measurement
- [REM] : REM measurement
- [RESEC] : Resection measurement
- [AREA] : Surface area measurement

## PROCEDURE Allocating a softkey

1. Select "Customize" to display <Customize/Select screen>. Select the measurement mode in which you want to allocate a softkey.



Select "Softkey".

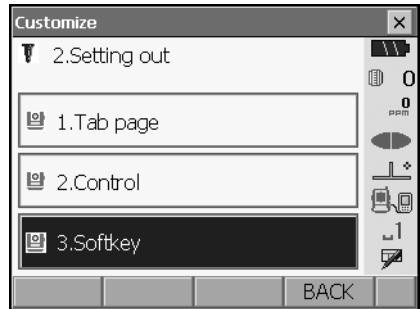

2. Select the desired tab. All softkeys currently allocated to each page of that tab are displayed.

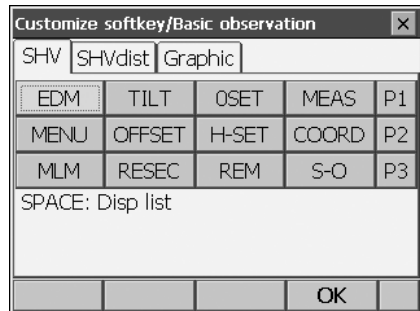

3. Select the softkey whose allocation you want to change. Tapping a softkey, or pressing **{SPACE}** when the cursor is aligned with a softkey, will display <Softkey list>.

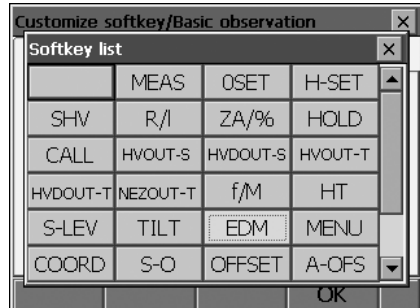

## 20. CHANGING THE SETTINGS

---

4. Select the desired softkey from <Softkey list> to allocate to the position specified in step 3.
5. Repeat steps 3 to 4 to perform further key allocations.
6. Press **[OK]** to finish allocating keys. The allocated keys are stored in memory and <Customize> is displayed. The newly allocated keys appear in the relevant measurement screen.

### 20.7 Changing Status Bar Icons

It is possible to preset icon allocations of the status bar to suit various applications and the ways that different operators handle the instrument.

- The current icon allocations are retained until they are revised again, even when the power is turned off.
- Press **[CLEAR]** in <Customize/Select screen> to return all customized configurations including tab pages, screen controls and softkey allocations to their previous settings.



- When icon allocations are recorded and registered, the previously recorded settings are cleared.
- When icon allocations are recorded and registered, the setting reflects to star key mode.

● The following icons can be allocated to the status bar:

- Remaining battery power
- Target display
- Guide light/Laser-pointer
- Tilt
- Communication status
- Input mode
- SIP (Input panel)
- Touch panel
- ppm (atmospheric correction factor)
- Disk
- No icon



## PROCEDURE Changing icon allocations

1. Select "Customize" to display <Customize/Select screen>.

Select "Status bar".

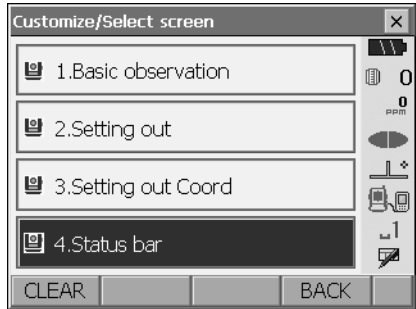

2. Select the icon position (in the status bar) you wish to re-allocate by tapping or using arrow key. A blue arrow will indicate the selected position.

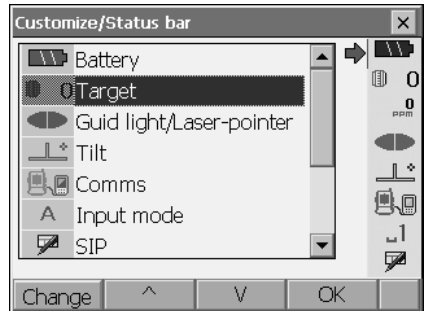

3. Select the new icon for the selected icon position. Select and change by double-tapping. Or Select using {▲}/ {▼} and tap [Change]/{ENT}.
4. Repeat steps 2 to 3 to perform further key allocations.
5. Press [OK] to finish allocating icons. The allocated icons are stored in memory and <Customize/Select screen> is displayed. The newly allocated icons appear in the status bar.

**20.8 Units**

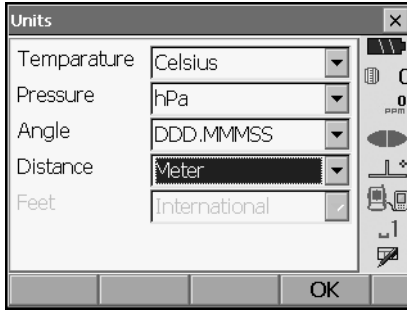

**Items set and options (\*: Factory setting)**

- Temperature: Celsius\*/Fahrenheit
- Pressure: hPa\*/mmHg/InchHg
- Angle: Degree (DDD.MMMSS)\*/Gon/Mil
- Distance: Meter\*/Feet/Inch
- Feet (only displayed when "Feet" or "Inch" selected above): International\*/US



- OS rounds off the value input by the digit of less than 0.004 feet/0.017 inch.



**Inch (Fraction of an inch)**

"Fraction of an inch" is the unit used in the United States and expressed like the following example.

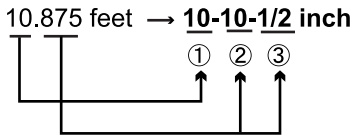

- ① 10.000 feet
- ② 0.875 feet x 12=10.5 inch
- ③ 0.5 inch=1/2 inch



- Even if "inch" is selected in this setting, all the data including the result of area calculation are output in "feet" and all the distance values must be input in "feet". In addition, when the "inch" display exceeds the range, it is displayed in "feet".

## 20.9 Changing Password

Setting a password allows you to protect important information such as measurement data and e-mail addresses.

No password was set when the FX was shipped. When setting a password for the first time, leave the "Old password" box blank.

When a password has been set, the password screen will appear when the FX is powered ON. Input the password to continue.



### Items set

Old password:	Input current password
New password:	Input the new password
New password again:	Input the new password again

- Password can be up to 16 characters in length. Input characters will be displayed as asterisks.
- To deactivate the password function, perform the new password setting procedure but enter a "space" in the "New password" box.



- The password function will not be canceled when a cold boot is performed.

## 20.10 Date and Time

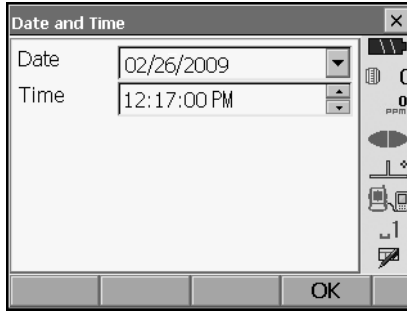

### Items set

- Date: Manually input date or select from the drop-down calendar by tapping ▼.
- Time: Manually input time or set using ▲/▼. Pressing {SPACE} will increment the selected section by 1.





### Date and Time

The FX includes a clock/calendar function.

## 20.11 Restoring Default Settings

Perform a cold boot to return all items to factory settings. A cold boot will not erase surveying data in FX. However, if the data in the memory is important, **BE SURE TO TRANSFER IT TO A PERSONAL COMPUTER BEFORE PERFORMING A COLD BOOT.**

"To perform a cold boot, while holding {}, and {S.P.}, press {}.

"All Settings will be cleared. Are you sure?"

Press [YES] to continue. Press {ESC} to cancel.

After [YES] is pressed the instrument powers ON and the screen for configuring the touch panel is displayed. Configure the touch panel to continue.

 "9.1 Configuring the Touch Panel"



- The password function will not be canceled.

# 21.WARNING AND ERROR MESSAGES

The following is a list of the error messages displayed by the FX and the meaning of each message. If the same error message is repeated or if any message not shown below appears, the instrument has malfunctioned. Contact your local dealer.

## **A new folder cannot be made in this folder !!**

A new folder cannot be created in the selected folder. Select a different location.

## **Backsight Z coord is Null !!**

Cannot compute. Backsight Z coord is set to "Null".  
Input the coordinate.

## **Backup battery dead. Clock display may no longer be correct.**

The voltage supplied by the lithium battery either declines or is completely discharged. Ask your local dealer to replace the battery for you.

## **Bad condition**

The air is shimmering a lot, etc., measuring conditions are poor.

The center of the target cannot be sighted.  
Resight the target.

Unsuitable distance measurement conditions when reflectorless measurement is set. When reflectorless measurement is set, distance cannot be measured because the laser beam is striking at least two surfaces at the same time.

Choose a single surface target for distance measurement.

 Precautions for setting prism: "11. FOCUSING AND TARGET SIGHTING"

## **Bad letter !!**

A file name containing special characters such as "\*" and "?" is invalid.

## **Calculation error**

During resection measurement the same point is registered multiple times. Set another known point so that the known point coordinates do not coincide.

Coordinates identical to the known point coordinates observed during resection exist.

During surface area calculation, conditions necessary for calculations are not met. Check conditions and try again.

An error occurred during calculation.

## **Checksum error !!**

A sending/repetition error has occurred between the total station and external equipment.  
Send/receive the data again.

## **Code error !!**

Cannot read/write code file.

## **Data not found !!**

No data found corresponding to input point number.

## 21. WARNING AND ERROR MESSAGES

---

### **Device list is full !!**

No more *Bluetooth* devices can currently be registered. Delete unnecessary devices from the list and try again.

### **Disconnect *Bluetooth***

Wireless connection disconnected. Re-connect and try again.

### **Error: Read Build Info.**

### **Error: Read sysflg**

### **Error: Self check**

### **Error: Read OS Parameter**

### **Error: Write sysflg**

Press **[OK]** to cancel the message. If this error message appears frequently, contact your local dealer.

### **File does not exist !!**

No file exists with the input filename.

### **Folder already exists !!**

The folder name input already exists.

### **Folder creation error !!**

Folder creation failed.

### **Incorrect password.**

Input password does not match set password. Input correct password.

### **Input device name !!**

*Bluetooth* device name not input. Input device name and complete device registration.

### **Input over 3 letters !**

The input password consists of less than 3 characters. Input a password at least 3 characters in length.

### **It is not possible to save in this folder !!**

Data cannot be saved in the selected folder. Select a different save location.

### **Linear !!**

The three input points form a straight line.

### **Need base pt. obs**

During REM measurement, the observation of the target was not completed normally. Reset and sight the prism and perform measurement again.

### **Need 1st obs**

During missing line measurement, the observation of the starting position was not completed normally.

Sight the starting position accurately and press **[MEAS]** to perform the measurement again.

### **New password Diff.**

During new password setting, the passwords input twice are different. Input new password twice correctly.

### **No data**

When searching for or reading in coordinate data or searching for code data, the search stopped either because the item in question does not exist or the data volume is large.

### **North/East is null**

Coordinates cannot be read in when either the northing or easting value is set to "Null".

### **No solution**

The calculation of the instrument station coordinates during resection does not converge. Access the results and if necessary, perform the observations again.

### **Out of range**

During gradient % display, the display range (less than  $\pm 1000\%$ ) has been exceeded. During REM measurement, either the vertical angle has exceeded horizontal  $\pm 89^\circ$  or the measured distance is greater than 9999.999m. Install the instrument station far from the target.

The instrument station coordinates calculated during resection are too high. Perform the observation again.

During area calculation, results exceeded the display range.

### **Receive error !!**

Reception failed.

### **Receive format error !!**

Check the received data.

### **Send error !!**

Send failed.

### **Signal off**

The reflected light is not observed when distance measurement begins. Or, during measurement, the reflected light has weakened or is blocked.

Either sight the target again or, when using a reflective prism, increase the number of reflective prisms.

### **Target not found !!**

The prism cannot be found within the Search area range. Reset and sight the prism and perform measurement again.

### **Temp Rnge OUT**

FX is outside useable temperature range and accurate measurement cannot be performed. Repeat measurement within the appropriate temperature range.

### **Tilt over range !!**

The tilt angle exceeds the tilt angle compensation range of the sensor. Sight again within  $\pm 1'$ .

### **Time out !!**

Measurement is not carried out in the allotted time.

Reset and sight the prism and perform measurement again.



# 22.CHECKS AND ADJUSTMENTS

FX is a precision instrument that requires fine adjustments. It must be inspected and adjusted before use so that it always performs accurate measurements.

- Always perform checking and adjustment in the proper sequence beginning from "22.1 Circular Level" to "22.6 Additive Distance Constant".
- In addition, the instrument should be inspected with special care after it has been stored a long time, transported, or when it may have been damaged by a strong shock.
- Make sure the instrument is securely set up and stable before performing checks and adjustments.

## 22.1 Circular Level

1. Level while checking the display.

 "8.2 Levelling"

### Note

- Tap  in the status bar or tap Tilt angle compensation icon in star mode to display electric circular level.



- If the tilt sensor is misaligned, the circular level is not adjusted correctly.

 "22.2 Tilt Sensor"

2. Check the position of the bubble of the circular level.

If the bubble is not off-center, no adjustment is necessary.

If the bubble is off-center, perform the following adjustment.

3. First confirm the off-center direction.  
Use the adjusting pin to loosen the circular level adjustment screw on the side opposite to the direction the bubble is displaced to move the bubble to the center.

4. Adjust the adjusting screws until the tightening tension of the three screws is the same to align the bubble in the middle of the circle.



- Be careful that the tightening tension is identical for all the adjusting screws. Also, do not over-tighten the adjusting screws as this may damage the circular level.

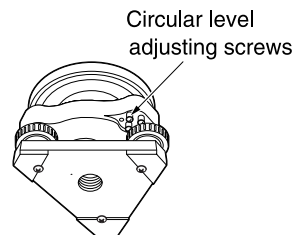
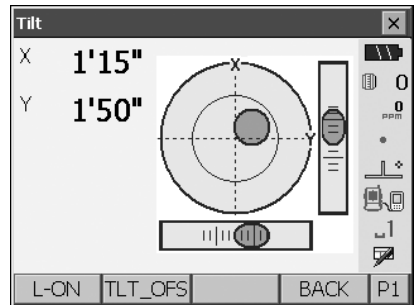

## 22.2 Tilt Sensor

If the tilt angle shown on the display shifts from tilt angle  $0^\circ$  (zero point), the instrument is not correctly levelled. This will adversely affect angle measurement.

Perform the following procedure to cancel the tilt zero point error.

### PROCEDURE Checking and adjusting

- Carefully level the FX. If necessary, repeat the procedures to check and adjust the bubble levels.
- Select "Inst. cons." in <Configuration>

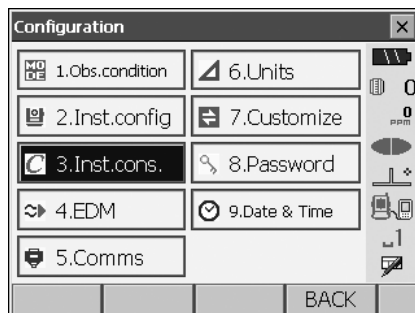

- Select "Tilt offset".

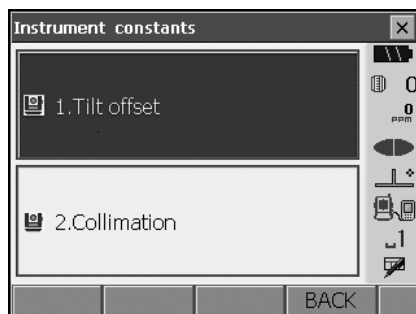

- Level the instrument until the X/Y tilt angles are  $\pm 1'$ . Wait a few seconds for the display to stabilize, then read the current tilt angle in the X (sighting) direction and Y (horizontal axis) direction.

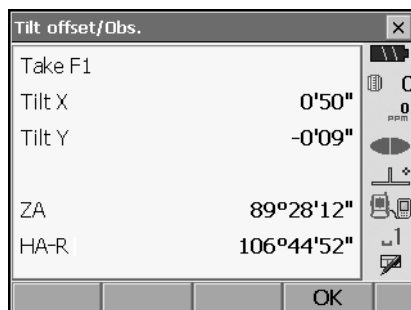

5. Press **[OK]** and rotate the top of the instrument and telescope 180° from the current position.
6. Wait a few seconds for the screen to stabilize, then read the automatically compensated angles X2 and Y2.
7. In this state, calculate the following offset values (tilt zero point error).  
 $X_{\text{offset}} = (X1+X2)/2$   
 $Y_{\text{offset}} = (Y1+Y2)/2$

If one of the offset values ( $X_{\text{offset}}$ ,  $Y_{\text{offset}}$ ) exceeds  $\pm 10''$ , adjust the value using the following procedure.  
 When the offset value falls within the range  $\pm 10''$ , adjustment is not necessary.  
 Press **{ESC}** to return to <Instrument constants>.

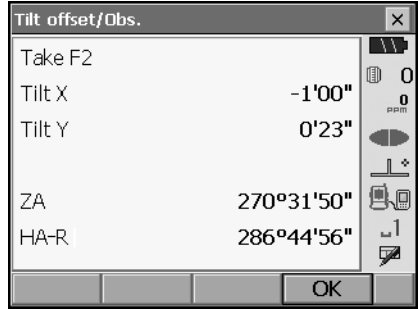

8. Press **[OK]** and rotate the top of the instrument and telescope through 180°.
9. Confirm that the values are in the adjustment range.  
 If both correction constants are within the range the current value  $\pm 3'$ , select **[YES]** to renew the correction angle. <Instrument constants> is restored. Continue to step 11.  
 If the values exceed the adjustment range, select **[NO]** to cancel the adjustment and return to the screen in step 4. Contact your local dealer to perform the adjustment.

Results for target point

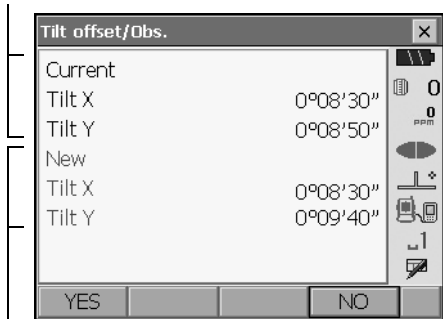

Results for offset point

**PROCEDURE Recheck**

10. Select "Tilt offset".
11. Wait a few seconds for the display to stabilize, then read the automatically compensated angles X3 and Y3.
12. Press **[OK]** and rotate the top of the instrument and telescope through 180°.
13. Wait a few seconds for the display to stabilize, then read the automatically compensated angles X4 and Y4.

## 22. CHECKS AND ADJUSTMENTS

---

14. In this state, the following offset values (tilt zero point error) are calculated.

$$X_{\text{offset}} = (X3+X4)/2$$

$$Y_{\text{offset}} = (Y3+Y4)/2$$

When both offset values fall within the range  $\pm 10''$ , adjustment is completed.

Press **{ESC}** to return to <Instrument constants>.

If one of the offset values ( $X_{\text{offset}}$ ,  $Y_{\text{offset}}$ ) exceeds  $\pm 10''$ , repeat the check and adjustment procedures from the beginning. If the difference continues to exceed  $\pm 10''$  after repeating the check 2 or 3 times, have your local dealer perform the adjustment.

## 22.3 Collimation

With this option you can measure collimation error in your instrument so that the FX can correct subsequent single face observations. To measure the error, make angular observations using both faces.

### PROCEDURE

1. Select "Inst. cons." in <Configuration>.
2. Select "Collimation".
3. Sight the reference point in Face 1 and press **[OK]**. Telescope rotates and vertical circle is indexed.
4. Sight the reference point in Face 2 and press **[OK]**.

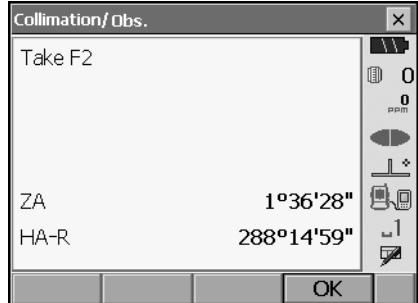
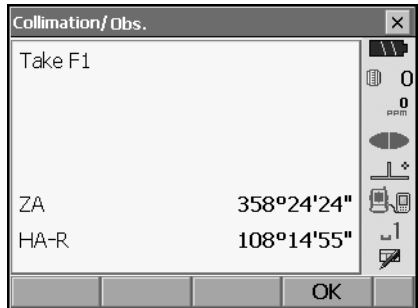
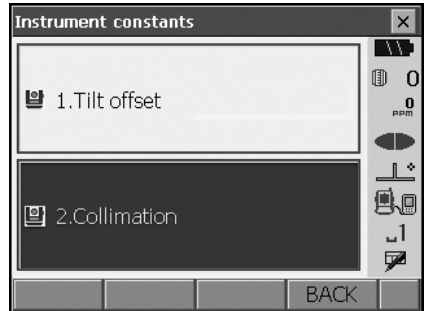

## 22. CHECKS AND ADJUSTMENTS

5. Press [YES] to set the constant.

- Press [NO] to discard the data and return to the screen in step 3.

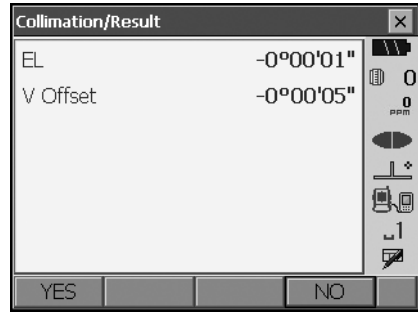

### 22.4 Reticle

With this option you can check the perpendicularity of the reticle and the horizontal/vertical positions of reticle lines.



- Check the telescope reticle by sighting the target.

#### PROCEDURE Check 1: Perpendicularity of the reticle to the horizontal axis

1. Carefully level the instrument.
2. Align a clearly visible target (the edge of a roof for example) on point A of the reticle line.

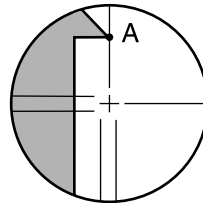

3. Use the fine motion screws to align the target to point B on a vertical line.  
If the target moves parallel to the vertical line, adjustment is unnecessary. If its movement deviates from the vertical line, have our service representative adjust it.

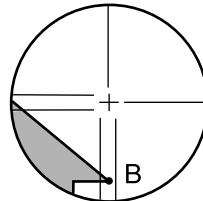

#### PROCEDURE Check 2: Vertical and horizontal reticle line positions

1. Carefully level the instrument.

2. Install a target at a point about 100m in the horizontal direction from the FX.



3. While the Observation mode screen is displayed and the telescope is in face left, sight the center of the target and read out the horizontal angle A1 and the vertical angle B1.

Example:

Horizontal angle A1 = 18° 34' 00"

Vertical angle B1 = 90° 30' 20"

4. While the telescope is in face right, sight the center of the target and read out the horizontal angle A2 and the vertical angle B2.

Example:

Horizontal angle A2 = 198° 34' 20"

Vertical angle B2 = 269° 30' 00"

5. Do the calculations: A2-A1 and B2+B1

If A2-A1 is within  $180^\circ \pm 20''$  and B2+B1 is within  $360^\circ \pm 20''$ , adjustment is unnecessary.

Example: A2-A1 (Horizontal angle)

=  $198^\circ 34' 20'' - 18^\circ 34' 00''$

=  $180^\circ 00' 20''$

B2+B1 (Vertical angle)

=  $269^\circ 30' 00'' + 90^\circ 30' 20''$

=  $360^\circ 00' 20''$

If the difference is large even after repeating the check 2 or 3 times, have our service representative perform the adjustment.

### 22.5 Optical Plummet

---



- Be careful that the tightening tension is identical for all the adjusting screws.
- Also, do not over-tighten the adjusting screws as this may damage the circular level.

#### PROCEDURE Checking

---

1. Carefully level the FX and center a survey point precisely in the reticle of the optical plummet.
2. Turn the upper part through 180° and check the position of the survey point in the reticle.  
If the surveying point is still centered, no adjustment is necessary.  
If the survey point is no longer centered in the optical plummet, perform the following adjustment.

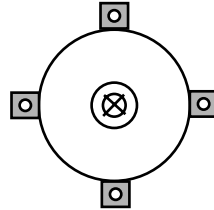

#### PROCEDURE Adjustment

---

3. Correct half the deviation with the levelling foot screw.
4. Remove the optical plummet reticle cover.

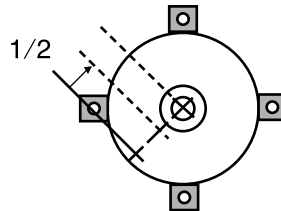



- Use the 4 adjusting screws of the optical plummet to adjust the remaining half of the deviation as shown below.

When the survey point is on the lower (upper) part of the illustration:

Loosen the upper (lower) adjusting screw slightly, and tighten the upper (lower) adjusting screw the same amount to move the survey point to a point directly under the center of the optical plummet. (It will move to the line in the figure on the right.)

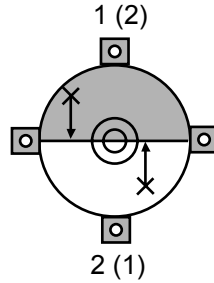

If the survey point is on the solid line (dotted line):

Loosen the right (left) adjusting screw slightly and, tighten the left (right) adjusting screw by the same amount to move the survey point to a point in the center of the optical plummet.

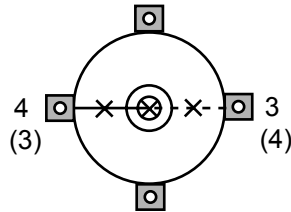

- Check to make sure that the survey point remains centered on the reticle even if the upper part of the instrument is rotated. If necessary, perform the adjustment again.

- Replace the optical plummet reticle cover.

## 22.6 Additive Distance Constant

The additive distance constant  $K$  of the FX is adjusted to 0 before delivery. Although it almost never deviates, use a baseline with a known distance precision to check that the additive distance constant  $K$  is close to 0 several times a year and whenever the values measured by the instrument begin to deviate by a consistent amount. Perform these checks as follows.



- Errors in setting up the instrument and reflective prism or in sighting the target will influence the additive distance constant. Be extremely careful to prevent such errors when performing these procedures.
- Set up so that the instrument height and the target height are identical. If a flat place is not available, use an automatic level to make sure the heights are identical.

## 22. CHECKS AND ADJUSTMENTS

---

### PROCEDURE Check

---

1. Find an area of flat ground where two points 100m apart can be selected.  
Set up the Instrument at point A and the reflective prism at point B. Establish a point C half way between points A and B.

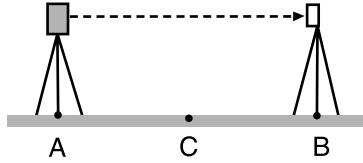

2. Precisely measure the horizontal distance between point A and point B 10 times and calculate the average value.
3. Place the FX at point C directly between points A and B and set up the reflective prism at point A.

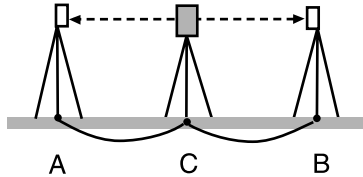

4. Precisely measure the horizontal distances CA and CB 10 times each and calculate the average value for each distance.
5. Calculate the additive distance constant K as follows.  
$$K = AB - (CA + CB)$$
6. Repeat steps 1 to 5 two or three times.  
If the additive distance constant K is within  $\pm 3\text{mm}$  even once, adjustment is unnecessary.  
If it always exceeds this range, have our service representative perform an adjustment.

## 22.7 Laser Plummet (Option)

Checks and adjustments are performed using an adjustment target. Make an enlarged or reduced copy of it.

### PROCEDURE Check

1. Level the instrument and emit the laser plummet beam.

 8.2 Levelling

2. Rotate the upper part horizontally and place a target so that it is aligned with the center of the circle created by the rotating laser plummet beam.

- Laser beam remains centered on the center of the target – No adjustment necessary
- Laser beam strays from the center of the target – Adjustment necessary.
- Laser beam draws a circle outside the target circle – Contact your local dealer.

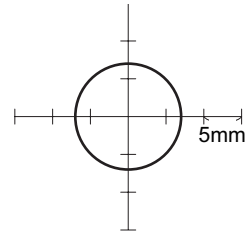

Adjustment target

### PROCEDURE Adjustment

1. Turn the laser plummet adjustment cap anticlockwise and remove.

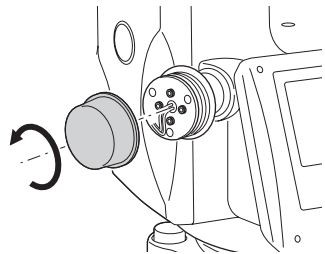

2. Emit the laser plummet beam.
3. Note the current position (x) of the laser beam.

## 22. CHECKS AND ADJUSTMENTS

4. Turn the upper part of the instrument horizontally through  $180^\circ$  and note the new position (y) of the laser beam.

Adjustment will bring the laser beam to a point midway along a line drawn between these two positions.

5. Check the position of the desired final position. Place a target so that its center is aligned with the desired final position.

The remaining deviation will be adjusted using the 4 fine adjustment screws.



- Be extremely careful to adjust all the fine adjustment screws by the same amount so that none will be over-tightened.
- Turn screws clockwise to tighten.

6. When the laser beam is on the upper (lower) part of Fig. A the up/down adjustment is made as follows:

- ① Insert the provided hexagon key wrench into both the upper and lower screws.

- ② Slightly loosen the upper (lower) screw and tighten the lower (upper) screw. Make sure that the tightening tension for both screws is identical. Continue to adjust until the laser beam is on the horizontal line of the target.

7. When the laser beam is in the right (left) part of Fig. B the left (right) adjustment is made as follows:

- ① Insert a hexagon key wrench into both the left and right screws.
- ② Slightly loosen the right (left) screw and tighten the left (right) screw. Make sure that the tightening tension for both screws is identical.

Continue to adjust until the laser beam is aligned with the target center.

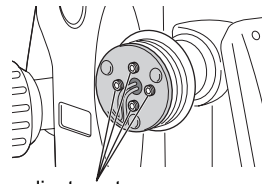
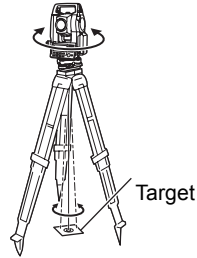
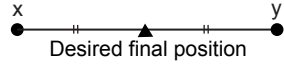

Fine adjustment screws

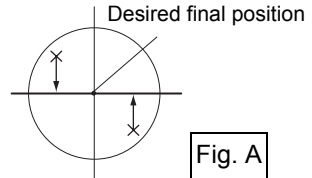

Fig. A

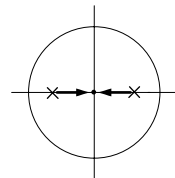
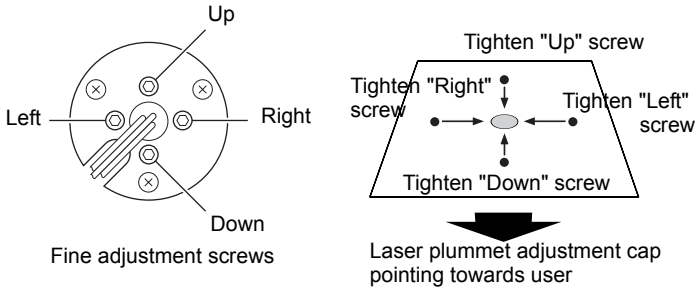

Fig. B

8. Turn the upper part of the instrument horizontally and check that the laser beam is now aligned with the target center.
9. Re-attach the laser plummet adjustment cap.

**Note**

- Tightening each of the fine adjustment screws moves the laser plummet beam in the directions shown below.



# 23. POWER SUPPLY SYSTEM

Operate your FX with the following combinations of power equipment.



- When using BDC60/61 and EDC139, mount the BDC70 in place to maintain the balance of the instrument.
- Never use any combination other than those indicated below. If you do, the FX could be damaged.

Those indicated by \* are standard accessories. Others are optional accessories (sold separately) for 101, 102, and low temperature models.

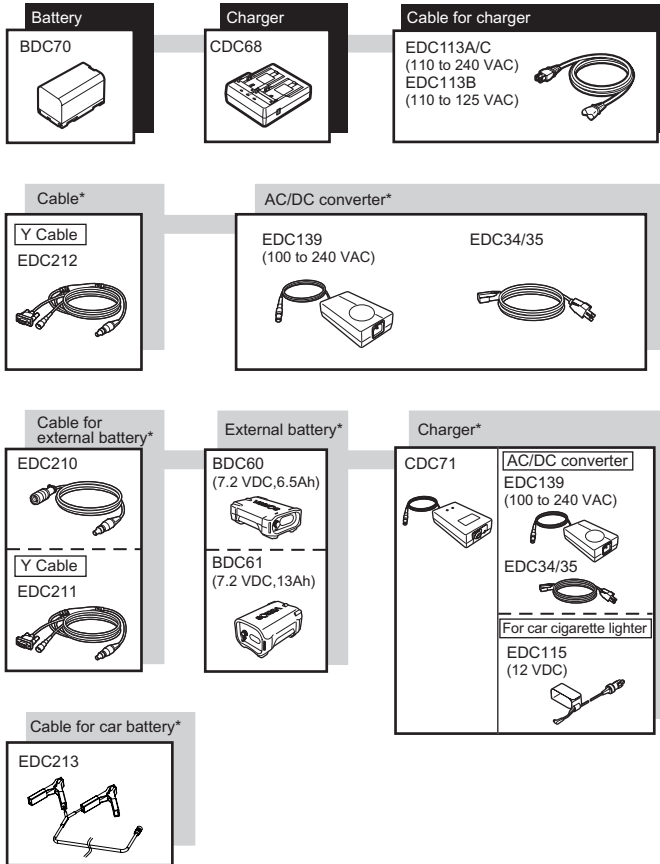

- By using the Y cable the FX can perform RS232C communication (D-sub 9-pin) at the same time as connecting to an external power source.

# 24.TARGET SYSTEM

- Because all SOKKIA reflecting prisms and accessories have standardized screws, it is possible to combine these prisms, accessories, etc. according to your objectives.
- The following are all special accessories (sold separately).
- Because these targets (\*2) are coated with fluorescent paint, they reflect when there is little light.



- When using a reflecting prism equipped with a target for distance and angle measurements, be sure to direct the reflective prism correctly and sight the center of the prism target accurately.
- Each reflective prism (\*1) has its own prism constant value. When changing prisms, be sure to change the prism constant correction value.
- To use the triple prism assembly AP31 or AP32 as a single prism for short distance measurements, mount the single reflective prism AP01AR in the center mounting hole of the prism holder.

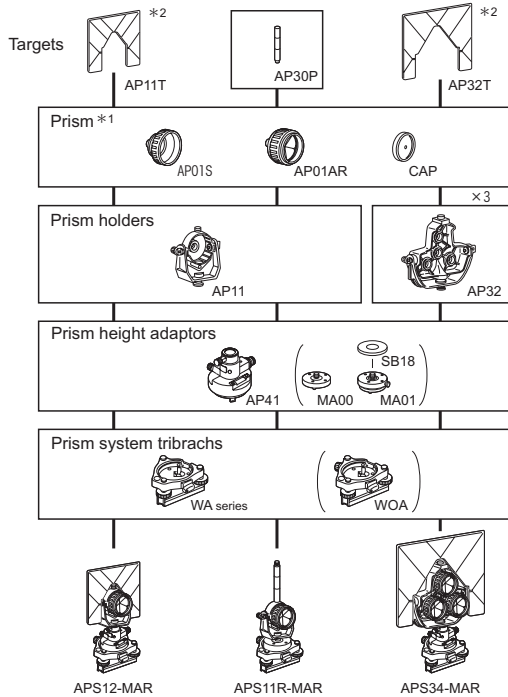

- **High-precision reflecting prism (CPS12)**  
Prism constant: -27

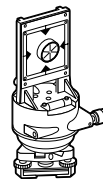

## 24. TARGET SYSTEM

- **2-point target (2RT500-K)**

This target is used for two-distance offset measurement.

Prism constant: 0

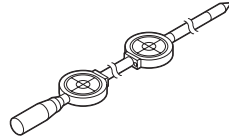

- **Instrument height adaptor (AP41)**

This device is used to adjust the height of the target.

Make sure that the instrument height “236” (mm) is displayed in the instrument height adjustment window.

1. Install the tribrach to the instrument height adaptor.

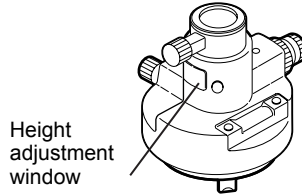

2. Level the instrument and check the position of the bubble of the plate level.

3. Turn the upper part through 180° and check the bubble position.  
If the bubble is still centered, no adjustment is necessary.  
If the bubble is off-center, adjust as follows.

4. Correct half of the bubble displacement using levelling foot screw C.

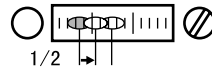

5. Correct the remaining half of the displacement by using the adjustment pin to rotate the plate level adjustment screw.

When the plate level adjustment screw is turned in the counterclockwise direction, the bubble moves in the same direction.

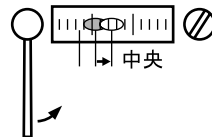

6. Rotate the top of the instrument and continue adjustments until the bubble remains centered for any position of the upper part.

If the bubble does not move to the center even when the adjustment has been repeated, ask your local dealer to adjust it.

- Adjust the optical plummet of the AP41 instrument height adaptor following the checking and adjustment methods of optical plummet.

 "22.5 Optical Plummet"



# 25.OPTIONAL ACCESSORIES

The following are optional accessories which are sold separately from the FX.

☞ Power supply and target optional accessories: "23. POWER SUPPLY SYSTEM", "24. TARGET SYSTEM".

## ● Plumb bob

The plumb bob can be used to set up and center the instrument on days when there is little wind. To use the plumb bob, unwind its cord, pass it through the cord grip piece as shown in the figure to adjust its length, then suspend it from the hook attached to the centering screw.

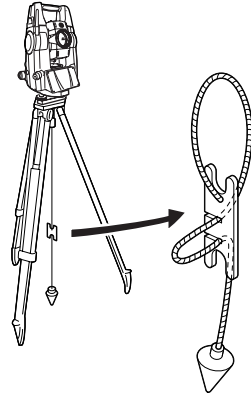

## ● Tubular compass (CP7)

Slide the tubular compass into the tubular compass slot, loosen the clamp screw, then rotate the top part of the instrument until the compass needle bisects the index lines. The telescope's face 1 sighting direction in this position will indicate magnetic north. After use, tighten the clamp and remove the compass from the slot.

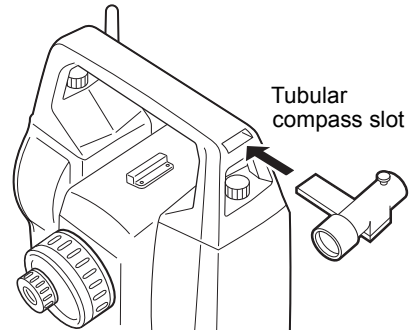

- The tubular compass is susceptible to the influence of nearby magnets or metal. Such influence could cause it to fail to accurately indicate magnetic north. Do not use magnetic north as indicated by this compass for base line surveying.

## ● Telescope eyepiece lens (EL7)

Magnification: 40X

Field of view: 1° 20'

● **Diagonal eyepiece (DE27)**

The diagonal eyepiece is convenient for observations near the nadir and in narrow spaces. Magnification: 30X

After removing the handle from the FX loosen the attachment screw to remove the telescope eyepiece. Then screw the diagonal lens into place.

☞ Handle removal method: "4.1 Parts of the Instrument "Handle""

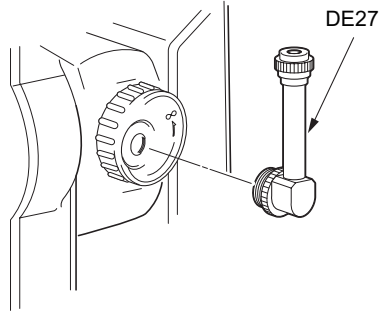

- Do not perform vertical rotation of the telescope when using the diagonal eyepiece. The diagonal eyepiece may strike the FX causing damage.

● **Solar filter (OF3A)**

When sighting targets where glare is present, solar observations for example, attach it to the objective lens of the FX to protect its interior and the eyes of its operator. The filter part can be flipped up without being removed.

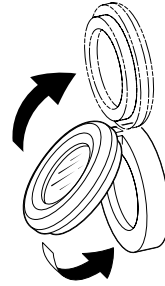

- Do not perform vertical rotation of the telescope when using the solar filter. The solar filter may strike the FX causing damage.

● **Interface cable**

Connect the FX to a host computer using the following cables.

Cable	Notes
DOC210	Pin number and signal level : RS232C compatible
EDC211 (Y cable)	D-Sub connector : 9 pins (female)
DOC212 (Y cable)	

**Note**

- By using the Y cable the FX can perform RS232C communication (D-Sub 9-pin) at the same time as connecting to an external power source. DOC25/26/27/1 are necessary when connecting EDC120/121 or DOC129 to DOC128.

# 26.SPECIFICATIONS

Except where stated, the following specifications apply to all FXs.

## Telescope

Length	171mm
Aperture	45mm (1.8 inch) (EDM: 48mm (1.9 inch))
Magnification	30X
Image	Erect
Resolving power:	
FX-101/102/103/105:	2.5"
FX-107:	3.5"
Field of view	1°30' (26m/1,000m)
Minimum focus	1.3m (4.3ft)
Focussing screw	1 speed
Reticle illumination	5 brightness levels

## Angle measurement

Horizontal and Vertical circles type

Rotary absolute encoder

Detecting

    FX-101/102/103: 2 sides

    FX-105/107: 1 side

Angle units

Degree/Gon/Mil (selectable)

Minimum display

    FX-101: 0.5"(0.0001gon/0.002mil)/1" (0.0002gon/0.005mil) (selectable)

    FX-102/103/105/107: 1" (0.0002gon/0.005mil)/5" (0.0010gon/0.020mil) (selectable)

Accuracy

    FX-101: 1" (0.0003gon/0.005mil)

    FX-102: 2" (0.0006gon/0.010mil)

    FX-103: 3" (0.001gon/0.015mil)

    FX-105: 5" (0.0015gon/0.025mil)

    FX-107: 7" (0.0022gon/0.035mil)

(ISO 17123-3 : 2001)

Collimation compensation

On/Off (selectable)

Measuring mode

    Horizontal angle: Right/Left (selectable)

    Vertical angle: Zenith/Horizontal/Horizontal  $\pm 90^\circ$ /% (selectable)

## Tilt angle compensation

Type

Liquid 2-axis tilt sensor

Correction unit

1"

Range of compensation

$\pm 6'$  ( $\pm 0.1111$ gon)

Compensation accuracy

    FX-101:  $\pm 3''$

    FX-102:  $\pm 6''$

    FX-103/105:  $\pm 10''$

    FX-107:  $\pm 12''$

Automatic compensator

ON (V & H/V)/OFF (selectable)

Compensation constant

Can be changed

## 26. SPECIFICATIONS

---

### Distance measurement

Measuring method	Coaxial phase-contrast measuring system
Signal source	Red laser diode 690nm Class 3R (IEC60825-1 Ed. 2.0: 2007/FDA CDRH 21CFR Part1040.10 and 1040.11 (Complies with FDA performance standards for laser products except for deviations pursuant to Laser Notice No.50, dated July 26, 2001.)) (When the prism or reflective sheet is selected in Config mode as target, the output is equivalent to Class 1)
Measuring range	(Using the following reflective prism/reflective sheet target during normal atmospheric conditions* <sup>1</sup> / * <sup>2</sup> is good atmospheric conditions/ * <sup>3</sup> is conditions for the low/high temperature models)
Reflective sheet RS90N-K* <sup>4</sup> :	1.3 to 500m (1,640ft) 1.3 to 300m (980ft)* <sup>3</sup>
Reflective sheet RS50N-K* <sup>4</sup> :	1.3 to 300m (980ft) 1.3 to 180m (590ft)* <sup>3</sup>
Reflective sheet RS10N-K* <sup>4</sup> :	1.3 to 100m (320ft) 1.3 to 60m (190ft)* <sup>3</sup>
Compact prism CP01:	1.3 to 2,500m (8,200ft)
Standard prism AP01AR X 1:	1.3 to 4,000m (13,120ft)* <sup>7</sup> 1.3 to 5,000m (16,400ft)* <sup>2</sup> * <sup>7</sup>
Standard prism AP01AR X 3:	1.3 to 5,000 m (16,400ft)* <sup>7</sup> 1.3 to 6,000m (19,680ft)* <sup>2</sup> * <sup>7</sup>
Mini pole prism OR1PA:	1.3 to 500m (1,640ft)
Reflectorless (White)* <sup>5</sup> :	0.3 to 500m (1,640ft) 0.3 to 200m (650ft)* <sup>8</sup>
Reflectorless (Gray)* <sup>6</sup> :	0.3 to 220m (720ft) 0.3 to 100m (320ft)* <sup>8</sup>
Minimum display	
Fine/Rapid measurement:	0.001 m (0.005ft/ 1/8 inch)
Tracking measurement:	0.01 m (0.05ft/ 1/2 inch)
Maximum slope distance display	
Prism/reflective sheet:	7680m (25,196.9ft)
Reflectorless:	768m (2519.7ft)
Distance unit	m/ft/inch (selectable)
Accuracy (Under normal atmospheric conditions* <sup>1</sup> )(ISO 17123-4 : 2001) (Using prism)	Fine measurement: $\pm(2 + 2 \text{ ppm} \times D)$ mm Rapid measurement: $\pm(5 + 2 \text{ ppm} \times D)$ mm
(Using reflective sheet target)* <sup>4</sup>	Fine measurement: $\pm(3 + 2 \text{ ppm} \times D)$ mm Rapid measurement: $\pm(5 + 2 \text{ ppm} \times D)$ mm
(Reflectorless (White))* <sup>5</sup>	Fine measurement: $\pm(3 + 2\text{ppm} \times D)$ mm (0.3 to 200m)

	$\pm(5 + 10\text{ppm} \times D)$ mm (over 200 to 350m) $\pm(10 + 10\text{ppm} \times D)$ mm (over 350 to 500m) Rapid measurement: $\pm(6 + 2\text{ppm} \times D)$ mm (0.3 to 200m) $\pm(8 + 10\text{ppm} \times D)$ mm (over 200 to 350m) $\pm(15 + 10\text{ppm} \times D)$ mm (over 350 to 500m)
(Reflectorless (Gray))* <sup>6</sup>	Fine measurement: $\pm(3 + 2\text{ppm} \times D)$ mm (0.3 to 100m) $\pm(5 + 10\text{ppm} \times D)$ mm (over 100 to 170m) $\pm(10 + 10\text{ppm} \times D)$ mm (over 170 to 220m) Rapid measurement: $\pm(6 + 2\text{ppm} \times D)$ mm (0.3 to 100m) $\pm(8 + 10\text{ppm} \times D)$ mm (over 100 to 170m) $\pm(15 + 10\text{ppm} \times D)$ mm (over 170 to 220m)
	(D: measurement distance; Unit: mm)
Measurement mode	Fine measurement (single/repeat/average)/Rapid measurement (single/repeat)/Tracking (selectable)
Measuring time	(fastest time under good atmospheric conditions* <sup>2</sup> , no compensation, EDM ALC at appropriate setting, slope distance)
Fine measurement:	less than 1.7 sec + every 0.9 sec or less
Rapid measurement:	less than 1.4 sec + every 0.7 sec or less
Tracking measurement:	less than 1.4 sec + every 0.3 sec or less
Atmospheric correction	
Temperature input range:	- 30 to 60°C (in 0.1°C step)/ - 22 to 140°F (in 1°F step)
Pressure input range:	500 to 1,400 hPa (in 1hPa step) 375 to 1,050 mmHg (in 1mmHg step) 14.8 to 41.3 inchHg (in 0.1inchHg step)
ppm input range:	-499 to 499 ppm (in 1 ppm step)
Prism constant correction	-99 to 99 mm (in 1 mm step) 0mm fixed for reflectorless measurement
Earth curvature and refraction correction	No/Yes K=0.14/Yes K=0.20 (selectable)
Sea level correction	No/Yes (selectable)

\*1: Slight haze, visibility about 20 km, sunny periods, weak scintillation.

\*2: No haze, visibility about 40 km, overcast, no scintillation.

\*3: Measurement at -30 to -20°C (-22 to -4°F) (Low Temperature Model)/50 to 60°C (122 to 140°F) (High Temperature Model)

\*4: Figures when the laser beam strikes within 30° of the reflective sheet target.

\*5: Figures when using Kodak Gray Card White side (reflection factor 90%) and brightness level is less than 30000 lx (a little cloudy).

\*6: Figures when using Kodak Gray Card Gray side (reflection factor 18%) and brightness level is less than 30000 lx (a little cloudy).

\*5,\*6: When performing reflectorless measurement, the possible measurement range and precision will change depending on the target reflection factor, weather conditions and location conditions.

\*7: Face the target toward the prism during the measurement with the distance at 10 m or less.

\*8: At the time of the tracking measurement.

## 26. SPECIFICATIONS

---

### Guide Light

Light source	LED (red 626 nm/green 524 nm)
Distance	1.3 to 150m*1
Visible range	Right and Left/Upward and Downward: $\pm 4^\circ$ (7m/100m)
Resolving power at center area (width)	4' (about 0.12/100m)
Brightness	3 levels (bright/normal/dim)

### Internal memory

Capacity	500 MB (includes memory for program files)
----------	--------------------------------------------

### External memory

USB flash memory (up to 8 GB)

### Data transfer

Data input/output	Asynchronous serial, RS232C compatible
USB	USB Ver. 1.1, Host (Type A) and Client (Type miniB)

### Bluetooth wireless communication (option)

Transmission method	FHSS
Modulation	GFSK
Frequency band	2.402 to 2.48GHz
Bluetooth profile	SPP, DUN
Power class	Class 1
Usable range	to 300m (usable range may vary with different paired devices) (No obstacles, few vehicles or sources of radio emissions/ interference in the near vicinity of the instrument, no rain)
Authentication	Yes/No (selectable)

### Power Supply

Power source	Rechargeable Li-ion battery BDC70
Working duration at 20 °C	Distance measurement (Fine distance measurement (single) repeated every 30 sec) BDC70: about 20 hours BDC60 (external battery, optional accessory): about 24 hours BDC61 (external battery, optional accessory): about 49 hours
Battery state indicator	4 levels
Auto power-off	5 levels (5/10/15/30 min/Not set) (selectable)
External power source	6.7 to 12V
Battery (BDC70)	
Nominal voltage:	7.2V
Capacity:	5,240mAh
Dimensions:	38 (W) x 70 (D) x 40 (H) mm
Weight:	about 195g
Charger (CDC68)	
Input voltage:	AC100 to 240V

Charging time per battery (at 25°C):

BDC70: about 5.5 hours

(Charging can take longer than the times stated above when temperatures are either especially high or low.)

Charging temperature range: 0 to 40°C

Storage temperature range: -20 to 65°C

Size: 94 (W) X 102 (D) X 36 (H) mm

Weight: about 170g

### General

Operating system	Windows Embedded CE 6.0
Display	3.5 inch Transflective TFT QVGA color LCD
Backlight:	LED: 9 brightness levels (0 to 8) (selectable)
Touch panel:	Resistance-sensitive analog type
Keyboard	26 keys
Key backlight:	Yes
Trigger key	Yes (right side)
Sensitivity of levels	
Circular level:	10 <sup>1</sup> / <sub>2</sub> mm
Electronic Circular levels:	
Graphic display range:	6' (inner circle)
Digital display range:	±6' 30"
Optical plummet	
Image:	Erect
Magnification:	3X
Minimum focus:	0.3 m
Laser plummet (option)	
Signal source:	Red laser diode 635 ±10nm (Class 2 IEC60825-1 Ed. 2.0:2007/FDA CDRH 21CFR Part 1040.10 and 1040.11 (Complies with FDA performance standards for laser products except for deviations pursuant to Laser Notice No.50, dated June 24, 2007.))
Beam accuracy:	1mm or less (when tripod head height is 1.3m).
Spot diameter:	ø3mm or less
Brightness control:	5 levels
Auto power-off:	Provided (power cut off after 5 minutes)
Calendar/clock function	Yes
Laser-pointer function	ON/OFF (selectable)
Operating temperature	
Standard models:	-20 to 50 °C (-4 to 122 °F)
Low temperature models:	-30 to 50 °C (-22 to 122 °F)
High temperature models:	-20 to 60 °C (-4 to 140 °F) (no direct sunlight)
Storage temperature range	-30 to 70°C (-22 to 158 °F) (no condensation)
Dust and water resistance	IP65 (IEC 60529:2001)
Instrument height:	192.5 mm from tribrach mounting surface 236mm +5/-3mm from tribrach bottom
Size (with handle)	
Display on one side:	191 (W) X 174 (D) X 348 (H) mm
Display on both sides:	191 (W) X 190 (D) X 348 (H) mm
Weight (with handle and battery)	5.7kg (12.3 lb)

# 27.EXPLANATIONS

## 27.1 Manually Indexing the Vertical Circle by Face Left, Face Right Measurement

The 0 index of the vertical circle of your FX is almost 100% accurate, but when it is necessary to perform particularly high precision angle measurements, you can eliminate any inaccuracy of the 0 index as follows.



- If the power is cut off, the vertical circle indexing is ineffective. Do it again every time the power is turned on.

### PROCEDURE

1. Select "Obs.condition" in <Configuration>. Set "V manual" (vertical circle indexing method) to "Yes".  
☞ "20.1 Observation Conditions"

<V manual 0 set> is displayed.

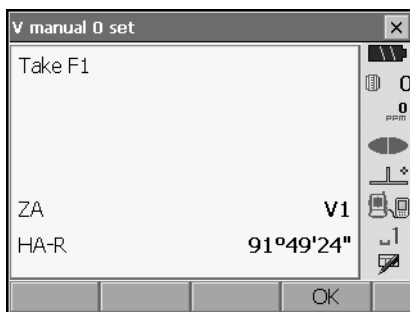

2. Carefully level the instrument.
3. Accurately sight a clear target with a distance of about 30m in the horizontal direction with the telescope in face left.  
Press **[OK]**. The vertical angle V2 is displayed under "Take F2".
4. Turn the upper part through 180° and clamp it. Then set the telescope in the face right position and accurately sight the same target.  
Press **[OK]**.  
The vertical and horizontal angles are displayed. This concludes the vertical circle indexing procedure.

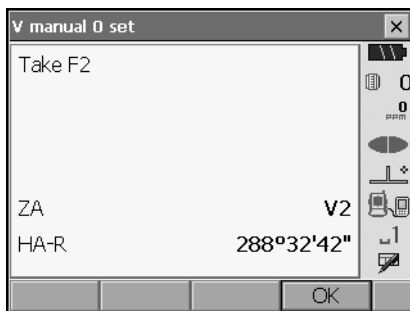





# 28.REGULATIONS



## Compliance with Environmental Directives & Regulations

Region/ Country	Directives/ Regulations	Labels/Declarations
California, U.S.A.	Proposition 65	<div style="border: 1px solid black; padding: 5px;"> <p><b>WARNING</b> : Handling the cord on this product or cords associated with accessories sold with this product, will expose you to lead, a chemical known to the State of California to cause birth defects or other reproductive harm. <b>Wash hands after handling.</b></p> </div>
California, U.S.A.	Perchlorate Material (CR Lithium Battery)	<div style="border: 1px solid black; padding: 5px;"> <p>This product contains a CR Lithium Battery which contains Perchlorate Material-special handling may apply. See <a href="http://www.dtsc.ca.gov/hazardouswaste/perchlorate/">http://www.dtsc.ca.gov/hazardouswaste/perchlorate/</a> Note ; This is applicable to California, U.S.A. only</p> </div>
California and NY, U.S.A.	Recycling Batteries	<div style="border: 1px solid black; padding: 10px;"> <p style="text-align: center;"><u><b>DON'T THROW AWAY RECHARGEABLE BATTERIES, RECYCLE THEM.</b></u></p> <p style="text-align: center;"><u><b>Sokkia Corporation United States Return Process for Used Rechargeable Nickel Metal Hydride, Nickel Cadmium, Small Sealed Lead Acid, and Lithium Ion, Batteries</b></u></p> <p>In the United States Sokkia Corporation has established a process by which SOKKIA customers may return used rechargeable Nickel Metal Hydride (Ni-MH), Nickel Cadmium (Ni-Cd), Small Sealed Lead Acid (Pb), and Lithium Ion (Li-Ion) batteries to Sokkia Corporation for proper recycling and disposal. Only SOKKIA batteries will be accepted in this process.</p> <p>Proper shipping requires that batteries or battery packs must be intact and show no signs of leaking. The metal terminals on individual batteries must be covered with tape to prevent short circuiting and heat buildup or batteries can be placed in individual plastic bags. Battery packs should not be disassembled prior to return.</p> <p>SOKKIA customers are responsible for complying with all federal, state, and local regulations pertaining to packing, labeling, and shipping of batteries. Packages must include a completed return address, be prepaid by the shipper, and travel by surface mode. <u><b>Under no circumstance should used/recyclable batteries be shipped by air.</b></u></p> <p>Failure to comply with the above requirements will result in the rejection of the package at the shipper's expense.</p> <p>Please remit packages to: Sokkia Corporation 16900 W, 118th Terrace Olathe, KS 66061</p> <p style="text-align: center;"><u><b>DON'T THROW AWAY RECHARGEABLE BATTERIES, RECYCLE THEM.</b></u></p> </div>

**28. REGULATIONS**

Region/ Country	Directives/ Regulations	Labels/Declarations
EU	WEEE Directive	<div style="border: 1px solid black; padding: 10px;">  <p><b>WEEE Directive</b> This symbol is applicable to EU member states only.</p> <p>Following information is only for EU-member states: The use of the symbol indicates that this product may not be treated as household waste. By ensuring this product is disposed of correctly, you will help prevent potential negative consequences for the environment and human health, which could otherwise be caused by inappropriate waste handling of this product. For more detailed information about the take-back and recycling of this product, please contact your supplier where you purchased the product or consult.</p> <p style="text-align: right;"><b>TOPCON CORPORATION</b></p> </div>
EU	EU Battery Directive	<div style="border: 1px solid black; padding: 10px;">  <p><b>EU Battery Directive</b> This symbol is applicable to EU member states only.</p> <p>Battery users must not dispose of batteries as unsorted general waste, but treat properly.</p> </div>

## Compliance with Electric Directives & Regulations

Region/ Country	Directives/ Regulations	Labels/Declarations
Europe	EMC-Class B R&TTE-Class 2	 <p><b>EMC NOTICE</b> In industrial locations or in proximity to industrial power installations, this instrument might be affected by electromagnetic noise. Under such conditions, please test the instrument performance before use.</p>
Europe	R&TTE-Class 2	<p><b>R&amp;TTE Directive</b></p> <p>FX series Hereby, TOPCON CORP., declares that the above-mentioned equipment is in compliance with the essential requirements and other relevant provisions of Directive 1999/5/EC.</p> <p>Please inquire below if you wish to receive a copy of Topcon's Declaration of Conformity.</p> <p>Topcon Europe Positioning B.V. Essebaan 11, 2908 LJ Capelle a/d IJssel, The Netherlands Tel:+31-10-4585077 Fax:+31-10-2844949 <a href="http://www.topcon-positioning.eu/index.asp">http://www.topcon-positioning.eu/index.asp</a></p>
Australia	C-Tick	

Region/ Country	Directives/ Regulations	Labels/Declarations
U.S.A.	FCC-Class A	<p><b>FCC Compliance</b></p> <p><b>WARNING:</b> Changes or modifications to this unit not expressly approved by the party responsible for compliance could void the user's authority to operate the equipment.</p> <p><b>NOTE:</b> This equipment has been tested and found to comply with the limits for a Class A digital device pursuant to Part 15 of the FCC Rules. These limits are designed to provide reasonable protection against harmful interference when the equipment is operated in a commercial environment. This equipment generates, uses, and can radiate radio frequency energy and, if not installed and used in accordance with the operator's manual, may cause harmful interference to radio communications. Operation of this equipment in a residential area is likely to cause harmful interference in which case the user will be required to correct the interference at his own expense.</p> <p>This transmitter must not be co-located or operated in conjunction with any other antenna or transmitter.</p> <p>This equipment complies with FCC radiation exposure limits set forth for uncontrolled equipment and meets the FCC radio frequency (RF) Exposure Guidelines in Supplement C to OET65. This equipment has very low levels of RF energy that is deemed to comply without maximum permissive exposure evaluation (MPE). But it is desirable that it should be installed and operated with at least 20cm and more between the radiator and person's body (excluding extremities: hands, wrists, feet and ankles).</p> <p><b>Declaration of Conformity</b> Model Number: FX series Trade Name: TOPCON CORPORATION</p> <p><b>Manufacture</b> Name: TOPCON CORPORATION Address: 75-1, Hasunuma-cho, Itabashi-ku, Tokyo, 174-8580 JAPAN 243-0036 Country: JAPAN</p> <p><b>U.S.A. Representative</b> Responsible party: SOKKIA CORPORATION Address: 16900 West 118th Terrace, Olathe, KS 66061, U.S.A</p> <p><b>Means of conformity</b> This device complies with part 15 of the FCC Rules, Operation is subject to the following two conditions: (1) This device may not cause harmful interference, and (2) this device must accept any interference received, including interference that may cause undesired operation.</p>

Region/ Country	Directives/ Regulations	Labels/Declarations
Canada	ICES-Class A	<p>This Class A digital apparatus meets all requirements of Canadian Interference-Causing Equipment Regulations. Cet appareil numérique de la Class A respecte toutes les exigences du Règlement sur le matériel brouilleur du Canada.</p> <p>This class A digital apparatus complies with Canadian ICES-003. Cet appareil numérique de la classe A est conforme a la norme NMB-003 du Canada.</p> <p>Operation is subject to the following two conditions: (1) this device may not cause interference, and (2) this device must accept any interference, including interference that may cause undesired operation of this device.</p> <p>This equipment complies with IC radiation exposure limits set forth for uncontrolled equipment and meets RSS-102 of the IC radio frequency (RF) Exposure rules. This equipment should be installed and operated with at least 20cm and more between the radiator and person's body (excluding extremities: hands, wrists, feet and ankles).</p>

# 29. INDEX

<b>A</b>	
ACK mode .....	41
Adjusting backlight brightness/turning the reticle illumination and key backlight ON/OFF .....	108
Atmospheric correction factor .....	111
Automatic tilt angle compensation mechanism .....	105
<b>B</b>	
Bluetooth connections .....	41
Bluetooth device address .....	44
<b>C</b>	
Cold boot .....	39
Collimation correction .....	106
<b>D</b>	
Date and Time .....	124
<b>E</b>	
EDM ALC .....	108
Eliminating parallax .....	50
<b>G</b>	
Guide light .....	11
<b>H</b>	
Hdist .....	105
Horizontal angle settings .....	64, 70
<b>I</b>	
Inch (Fraction of an inch) .....	122
Instrument height mark .....	11
<b>K</b>	
Key backlight .....	109
<b>L</b>	
Laser-pointer function .....	11
Laser-pointer off .....	109
<b>P</b>	
Power-saving automatic cut-off/Backlight Off .....	108
Precaution when performing resection .....	75
Prism constant correction .....	110
Problems Powering OFF .....	40
<b>R</b>	
Resection calculation process .....	74
Resume function .....	38
<b>S</b>	
Sea level correction .....	106
Sighting collimator .....	11
Slope area .....	100
<b>T</b>	
Terminate .....	41
Trigger key .....	11
<b>V</b>	
V mode (vertical angle display method) .....	106



---

## **TOPCON CORPORATION**

75-1 Hasunuma-cho, Itabashi-ku, Tokyo 174-8580, Japan <http://www.topcon.co.jp>

Please see the attached address list or the following website for contact addresses.

**GLOBAL GATEWAY** <http://global.topcon.com/>

---