

**INSTRUCTION MANUAL  
ELECTRONIC TOTAL STATION**

---

**GTS-230N SERIES**

**GTS-233N**

**GTS-235N**

**GTS-236N**

**GTS-239N**



# FOREWORD

Thank you for purchasing the TOPCON Electronic Total Station, GTS-230N series. For the best performance of the instruments, please carefully read these instructions and keep them in a convenient location for future reference.

## General Handling Precautions

**Before starting work or operation, be sure to check that the instrument is functioning correctly with normal performance.**

**Do not submerge the instrument into water.**

The instrument can not be submerged underwater.

The instrument is designed based on the International Standard IP66, therefore it is protected from the normal rainfall.

**Setting the instrument on a tripod**

When mounting the instrument on a tripod, use a wooden tripod when possible. The vibrations that may occur when using a metallic tripod can effect the measuring precision.

**Installing the tribrach**

If the tribrach is installed incorrectly, the measuring precision could be effected.

Occasionally check the adjusting screws on the tribrach. Make sure the base fixing lever is locked and the base fixing screws are tightened.

**Guarding the instrument against shocks**

When transporting the instrument, provide some protection to minimize risk of shocks.

Heavy shocks may cause the measurement to be faulty.

**Carrying the instrument**

Always carry the instrument by its handgrip.

**Exposing the instrument to extreme heat.**

Do not leave the instrument in extreme heat for longer than necessary. It could adversely affect its performance.

**Sudden changes of temperature**

Any sudden change of temperature to the instrument or prism may result in a reduction of measuring distance range, i.e when taking the instrument out from a heated vehicle. Let instrument acclimate itself to ambient temperature.

**Battery level check**

Confirm battery level remaining before operating.

**Taking the battery out**

It is recommended not to take the battery or external battery out during the power is on. All the data stored is possible gone at that time. So please do your assembling or taking the battery out after the power is off.



**Do not hold the lower part of display unit**

When you take out the instrument from a carrying case, or keep into the case, please hold the hand grip and base of the instrument. Please do not hold the lower part of the display unit.

## Display for Safe Use

In order to encourage the safe use of products and prevent any danger to the operator and others or damage to properties, important warnings are put on the products and inserted in the instruction manuals.

We suggest that everyone understand the meaning of the following displays and icons before reading the "Safety Cautions" and text.

Display	Meaning
 <b>WARNING</b>	<b>Ignoring or disregard of this display may lead to the danger of death or serious injury.</b>
 <b>CAUTION</b>	<b>Ignoring or disregard of this display may lead to personal injury or physical damage.</b>

\*Injury refers to hurt, burn, electric shock, etc.

\*Physical damage refers to extensive damage to buildings or equipment and furniture.

## Safety Cautions

 <b>WARNING</b>
<p>•<b>There is a risk of fire, electric shock or physical harm if you attempt to disassemble or repair the instrument yourself.</b> This is only to be carried out by TOPCON or an authorized dealer, only!</p>
<p>•<b>Cause eye injury or blindness.</b> Do not look at the sun through a telescope.</p>
<p>•<b>High temperature may cause fire.</b> Do not cover the charger while it is charging.</p>
<p>•<b>Risk of fire or electric shock.</b> Do not use damaged power cable, plug and socket.</p>
<p>•<b>Risk of fire or electric shock.</b> Do not use a wet battery or charger.</p>
<p>•<b>May ignite explosively.</b> Never use an instrument near flammable gas, liquid matter, and do not use in a coal mine.</p>
<p>•<b>Battery can cause explosion or injury.</b> Do not dispose in fire or heat.</p>
<p>•<b>Risk of fire or electric shock.</b> Do not use any power voltage except the one given on manufacturers instructions.</p>
<p>•<b>Battery can cause outbreak of fire.</b> Do not use any other type of charger other than the one specified.</p>
<p>•<b>Risk of fire.</b> Do not use any other power cable other than the one specified.</p>
<p>•<b>The short circuit of a battery can cause a fire.</b> Do not short circuit battery when storing it.</p>

 <b>CAUTION</b>
•Do not connect or disconnect equipment with wet hands, you are at risk of electric shocks if you do!
•Risk of injury by overturn the carrying case. Do not stand or sit on the carrying cases.
•Please note that the tips of tripod can be hazardous, be aware of this when setting up or carrying the tripod.
•Risk of injury by falling down the instrument or case. Do not use a carrying case with a damaged which belts, grips or latches .
•Do not allow skin or clothing to come into contact with acid from the batteries, if this does occur then wash off with copious amounts of water and seek medical advice.
•A plumb bob can cause an injury to a person if used incorrectly.
•It could be dangerous if the instrument falls over, please ensure you attach a handle battery to the instrument securely.
•Ensure that you mount the Tribach correctly, failing to do so may result in injury if the tribach were to fall over.
•It could be dangerous if the instrument falls over, please check that you fix the instrument to the tripod correctly.
•Risk of injury by falling down a tripod and an instrument. Always check that the screws of tripod are tightened.

## User

1)This product is for professional use only!

The user is required to be a qualified surveyor or have a good knowledge of surveying, in order to understand the user and safety instructions, before operating, inspecting or adjusting.

2)Wear the required protectors (safety shoes, helmet, etc.) when operating.

## Exceptions from Responsibility

1)The user of this product is expected to follow all operating instructions and make periodic checks of the product's performance.

2)The manufacturer, or its representatives, assumes no responsibility for results of a faulty or intentional usage or misuse including any direct, indirect, consequential damage, and loss of profits.

3)The manufacturer, or its representatives, assumes no responsibility for consequential damage, and loss of profits by any disaster, (an earthquake, storms, floods etc.).

A fire, accident, or an act of a third party and/or a usage any other usual conditions.

4)The manufacturer, or its representatives, assumes no responsibility for any damage, and loss of profits due to a change of data, loss of data, an interruption of business etc., caused by using the product or an unusable product.

5)The manufacturer, or its representatives, assumes no responsibility for any damage, and loss of profits caused by usage except for explained in the user manual.

6)The manufacturer, or its representatives, assumes no responsibility for damage caused by wrong movement, or action due to connecting with other products.

## Contents

<b>FOREWORD</b> .....	<b>1</b>
General Handling Precautions .....	1
Display for Safe Use .....	2
Safety Cautions.....	2
User .....	3
Exceptions from Responsibility .....	3
Contents .....	4
Standard Set Composition .....	7
<b>1 NOMENCLATURE AND FUNCTIONS</b> .....	<b>1-1</b>
1.1 Nomenclature .....	1-1
1.2 Display.....	1-3
1.3 Operating Key .....	1-4
1.4 Function Key (Soft Key) .....	1-5
1.5 Star key mode .....	1-6
1.6 Serial signal RS-232C connector .....	1-8
<b>2 PREPARATION FOR MEASUREMENT</b> .....	<b>2-1</b>
2.1 Power Connection .....	2-1
2.2 Setting Instrument Up For Measurement .....	2-2
2.3 Power Switch Key ON .....	2-3
2.4 Battery Power Remaining Display .....	2-4
2.5 Vertical and Horizontal Angle Tilt Correction.....	2-5
2.6 How to Enter Alphanumeric characters.....	2-7
2.6.1 How to Enter Alphanumeric Characters .....	2-7
<b>3 ANGLE MEASUREMENT</b> .....	<b>3-1</b>
3.1 Measuring Horizontal Angle Right and Vertical Angle.....	3-1
3.2 Switching Horizontal Angle Right/Left .....	3-2
3.3 Measuring from the Required Horizontal Angle .....	3-2
3.3.1 Setting by Holding the Angle .....	3-2
3.3.2 Setting a Horizontal Angle from the Keys.....	3-3
3.4 Vertical Angle Percent Grade(%) Mode .....	3-3
3.5 Repetition Angle Measurement.....	3-4
3.6 Buzzer Sounding for Horizontal Angle 90° Increments .....	3-5
3.7 Compasses ( vertical angle) .....	3-6
<b>4 DISTANCE MEASUREMENT</b> .....	<b>4-1</b>
4.1 Setting of the Atmospheric Correction.....	4-1
4.2 Setting of the Correction for Prism Constant.....	4-1
4.3 Distance Measurement (Continuous Measurement).....	4-1
4.4 Distance Measurement (N-time Measurement/Single Measurement) .....	4-2
4.5 Fine Mode/Tracking Mode/Coarse Mode .....	4-3
4.6 Stake Out (S.O).....	4-4
4.7 Offset Measurement .....	4-5
4.7.1 Angle Offset .....	4-6
4.7.2 Distance Offset Measurement .....	4-8
4.7.3 Plane Offset Measurement .....	4-10
4.7.4 Column Offset Measurement .....	4-12
<b>5 COORDINATE MEASUREMENT</b> .....	<b>5-1</b>
5.1 Setting Coordinate Values of Occupied Point.....	5-1
5.2 Setting Height of the Instrument .....	5-2
5.3 Setting Height of Target (Prism Height) .....	5-2
5.4 Execution of Coordinate Measuring .....	5-3
<b>6 SPECIAL MODE (Menu Mode)</b> .....	<b>6-1</b>
6.1 Application Measurement (PROGRAMS) .....	6-2
6.1.1 Remote Elevation measurement (REM).....	6-2







6.1.2	Missing Line Measurement (MLM)	6-5
6.1.3	Setting Z Coordinate of Occupied Point	6-8
6.1.4	Area Calculation	6-11
6.1.5	Point to Line Measurement	6-14
6.2	Setting the GRID FACTOR	6-16
6.3	Setting Illumination of Display and Cross Hairs	6-17
6.4	Setting Mode 1	6-18
6.4.1	Setting Minimum Reading	6-18
6.4.2	Auto Power Off	6-19
6.4.3	Vertical and Horizontal Angle Tilt correction ( Tilt ON/OFF)	6-19
6.4.4	Systematic Error of Instrument Correction (only for GTS-233N/235N/236N)	6-20
6.4.5	Selecting Battery Type	6-20
6.4.6	Heater ON/OFF	6-21
6.5	Setting Contrast of Display	6-21
6.6	ROAD	6-22
6.6.1	Input Start Point	6-23
6.6.2	Input Road Data	6-24
6.6.3	Search Data	6-28
6.6.4	Edit Data	6-28
6.6.5	Set OCC and BS	6-29
6.6.6	Setout Road	6-31
6.6.7	Select a File	6-32
6.6.8	Initialize ROAD data	6-32
<b>7</b>	<b>DATA COLLECTION</b>	<b>7-1</b>
7.1	Preparation	7-3
7.1.1	Selecting a File for Data Collection	7-3
7.1.2	Selecting a Coordinate File for Data Collection	7-4
7.1.3	Occupied Point and Backsight Point	7-4
7.2	Operational Procedure of "DATA COLLECT"	7-7
7.3	Data Collect Offset Measurement mode	7-10
7.3.1	Angle Offset Measurement	7-10
7.3.2	Distance Offset Measurement	7-12
7.3.3	Plane Offset Measurement	7-14
7.3.4	Column Offset Measurement	7-16
7.4	NEZ Auto Calculation	7-17
7.5	Editing PCODE Library [PCODE INPUT]	7-18
7.6	Setting Parameter of Data Collect [CONFIG.]	7-19
<b>8</b>	<b>LAYOUT</b>	<b>8-1</b>
8.1	Preparation	8-3
8.1.1	Setting the GRID FACTOR	8-3
8.1.2	Selecting Coordinate Data File	8-4
8.1.3	Setting Occupied Point	8-5
8.1.4	Setting Backsight Point	8-6
8.2	Executing a Layout	8-8
8.3	Setting a New Point	8-10
8.3.1	Side Shot Method	8-10
8.3.2	Resection Method	8-12
<b>9</b>	<b>MEMORY MANAGER MODE</b>	<b>9-1</b>
9.1	Display Internal Memory Status	9-2
9.2	Searching Data	9-3
9.2.1	Measured Data Searching	9-3
9.2.2	Coordinate Data Searching	9-5
9.2.3	PCODE LIBRARY Searching	9-6
9.3	FILE MAINTENANCE	9-7
9.3.1	Rename a File	9-8
9.3.2	Searching Data in a File	9-8
9.3.3	Deleting a File	9-9

9.4	Coordinate Data Direct Key Input	9-10
9.5	Delete a Coordinate Data from a File	9-11
9.6	Editing PCODE Library	9-12
9.7	Data Communications	9-13
9.7.1	Sending Data	9-13
9.7.2	Loading Data	9-14
9.7.3	Setting Parameter of Data Communications	9-15
9.8	Initialization	9-16
<b>10</b>	<b>SET AUDIO MODE</b>	<b>10-1</b>
<b>11</b>	<b>SETTING THE PRISM CONSTANT VALUE</b>	<b>11-1</b>
<b>12</b>	<b>SETTING ATMOSPHERIC CORRECTION</b>	<b>12-1</b>
12.1	Calculation of Atmospheric Correction	12-1
12.2	Setting of Atmospheric Correction Value	12-1
<b>13</b>	<b>CORRECTION FOR REFRACTION AND EARTH CURVATURE</b>	<b>13-1</b>
13.1	Distance Calculation Formula	13-1
<b>14</b>	<b>POWER SOURCE AND CHARGING</b>	<b>14-1</b>
14.1	On-board Battery BT-52QA	14-1
<b>15</b>	<b>DETACH/ATTACH OF TRIBRACH</b>	<b>15-1</b>
<b>16</b>	<b>SELECTING MODE</b>	<b>16-1</b>
16.1	Items of the Selecting Mode	16-1
16.2	How to Set Selecting Mode	16-3
<b>17</b>	<b>CHECK AND ADJUSTMENT</b>	<b>17-1</b>
17.1	Checking and adjusting of instrument constant	17-1
17.2	Checking the Optical Axis	17-2
17.3	Checking/Adjusting the Theodolite Functions	17-3
17.3.1	Checking /Adjusting the Plate Level	17-4
17.3.2	Checking /Adjusting the Circular Level	17-4
17.3.3	Adjustment of the Vertical Cross-hair	17-5
17.3.4	Collimation of the Instrument	17-6
17.3.5	Checking / Adjusting the Optical Plummet Telescope	17-7
17.3.6	Adjustment of Vertical Angle 0 Datum	17-8
17.4	How to Set the Instrument Constant Value	17-9
17.5	Adjustment of Compensation Systematic Error of Instrument	17-10
17.6	Reference frequency check mode	17-12
<b>18</b>	<b>PRECAUTIONS</b>	<b>18-1</b>
<b>19</b>	<b>SPECIAL ACCESSORIES</b>	<b>19-1</b>
<b>20</b>	<b>BATTERY SYSTEM</b>	<b>20-1</b>
<b>21</b>	<b>PRISM SYSTEM</b>	<b>21-1</b>
<b>22</b>	<b>ERROR DISPLAYS</b>	<b>22-1</b>
<b>23</b>	<b>SPECIFICATIONS</b>	<b>23-1</b>
<b>APPENDIX</b>	<b>Appendix-1</b>	
	Dual Axis Compensation	Appendix-1
	Precaution when Charging or Storing Batteries	Appendix-3

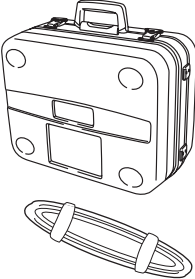
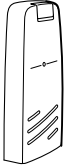
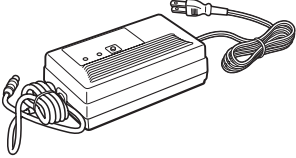

## Standard Set Composition

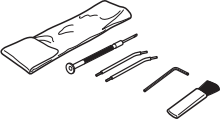
The numerical value in parentheses shows the quantity.

<p>GTS-230N series (with lens cap) (1)</p> 	<p>Plastic carrying case(1)</p> 
<p>On-board Battery BT-52QA (1)</p> 	<p>Battery charger BC-27BR or BC-27CR (1)</p> 
<p>Sun shade(1)</p> 	<p>Plastic rain cover(1)</p> 
<p>Plumb bob set(1)</p>  <p>Plumb bob hook is including in the tool kit case.</p>	<p>Tool kit with case (1) [rod pin(2), screwdriver, hexagonal wrench, cleaning brush ]</p> 
<p>Instruction manual (1)</p> 	<p>Silicon cloth (1)</p> 

(Make sure that all of the above items are with the instrument when purchased.)

**Remarks:**

- 1) Battery charger BC-27CR is for AC 230V use and BC-27BR is for AC 120V use.
- 2) Plumb bob set and plumb bob hook are supplied for certain markets.

# 1 NOMENCLATURE AND FUNCTIONS

## 1.1 Nomenclature

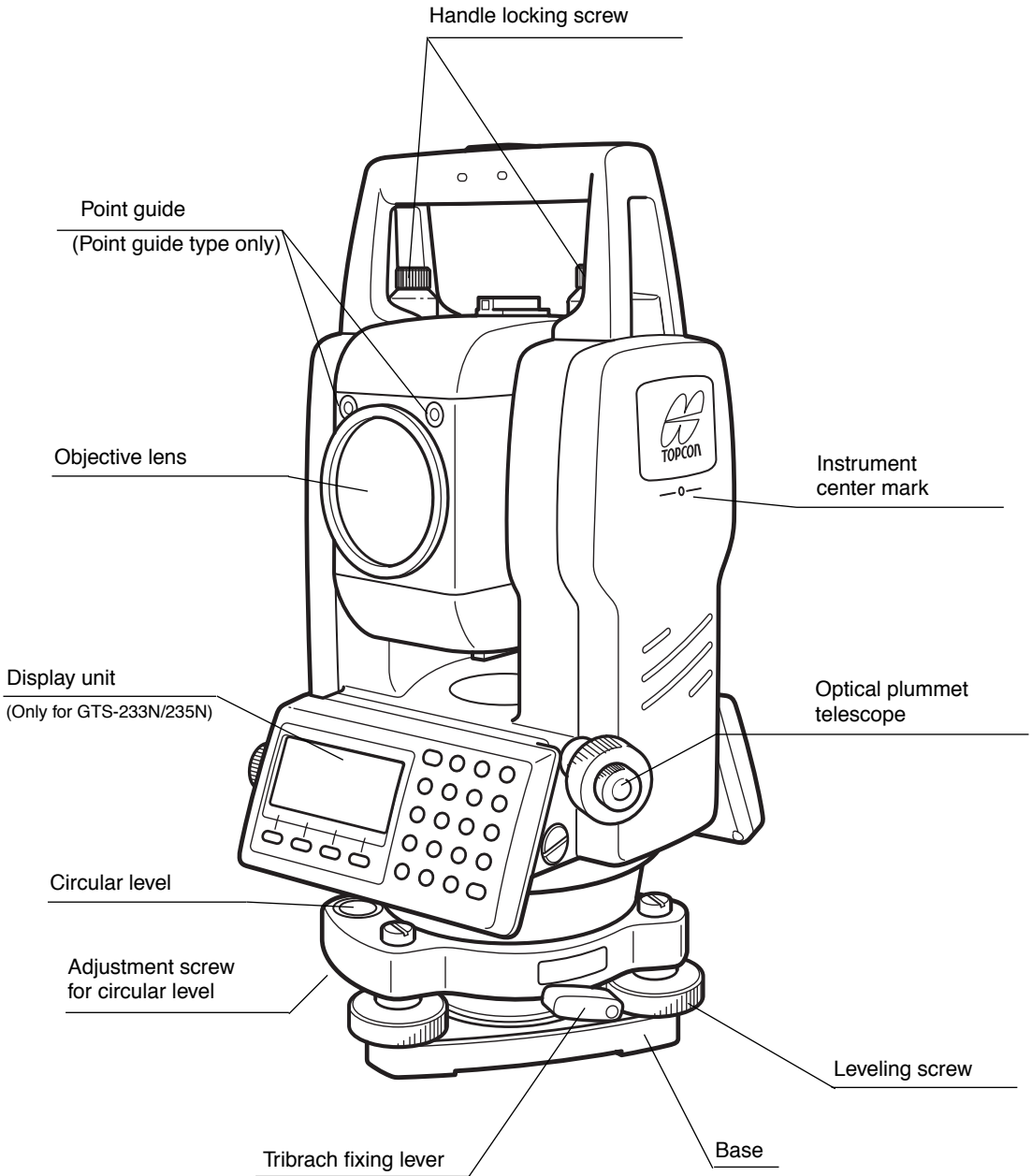

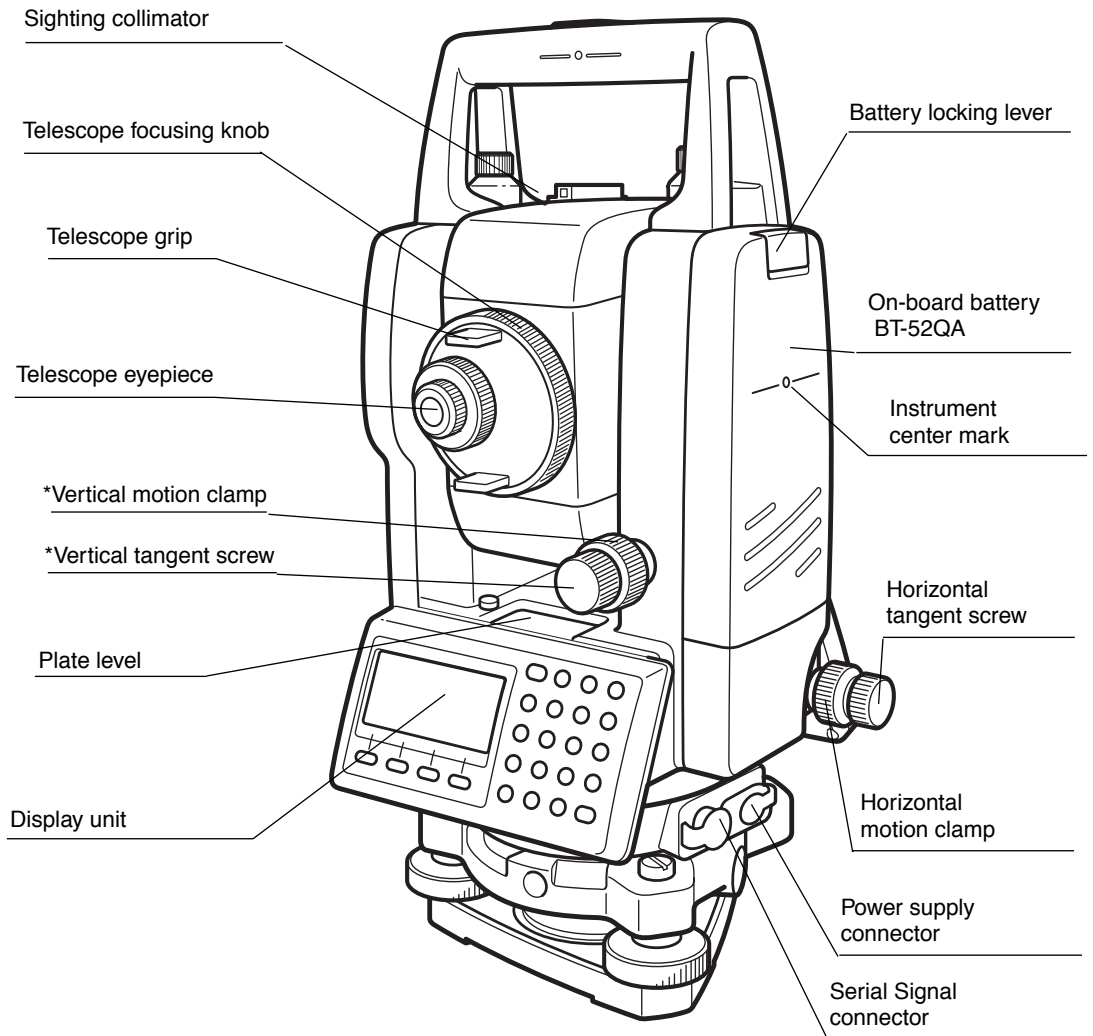

\*The position of vertical motion clamp and Vertical tangent screw will differ depending on the market.

## 1.2 Display

- **Display**

The display uses a dot matrix LCD which has 4 lines and 20 characters per line. In general, the upper three lines display measured data, and the bottom line displays the soft key function which changes with the measuring mode.

- **Contrast and Illumination**

The contrast and illumination of display window are adjusted. see Chapter 6 “SPECIAL MODE (Menu Mode)” or section 1.5 “Star key mode”.

- **Heater (Automatic)**

The built-in automatic heater functions when the temperature is below 0°C. This keeps the display's speed up at temperatures lower than 0°C. To set the heater ON/OFF, see section 6.4.6 “Heater ON/OFF”. The operating time will become short if a heater is used.

- **Example**

<b>V : 90°10'20"</b> <b>HR: 120°30'40"</b>  <b>OSET HOLD HSET P1↓</b>
--

Angle measurement mode

V-angle : 90°10'20"  
H-angle : 120°30'40"

Feet unit

<b>HR: 120°30'40"</b> <b>HD* 123.45 f</b> <b>VD: 12.34 f</b> <b>MEAS MODE S/A P1↓</b>
--

Horizontal-angle : 120°30'40"  
Horizontal distance : 123.45ft  
Relative elevation : 12.34ft

<b>HR: 120°30'40"</b> <b>HD* 65.432 m</b> <b>VD: 12.345 m</b> <b>MEAS MODE S/A P1↓</b>
---

Distance measurement mode

Horizontal-angle : 120°30'40"  
Horizontal distance : 65.432m  
Relative elevation : 12.345m

Feet and inch unit

<b>HR: 120°30'40"</b> <b>HD* 123.04.6f</b> <b>VD: 12.03.4f</b> <b>MEAS MODE S/A P1↓</b>
--

Horizontal-angle : 120°30'40"  
Horizontal distance : 123ft4in6/8in  
Relative elevation : 12ft3in4/8in

- **Display marks**

Display	Contents	Display	Content
V	V-angle	*	EDM working
HR	H-angle right	m	Meter unit
HL	H-angle left	f	Feet and inch unit
HD	Horizontal distance		
VD	Relative elevation		
SD	Slope distance		
N	N coordinate		
E	E coordinate		
Z	Z coordinate		

### 1.3 Operating Key

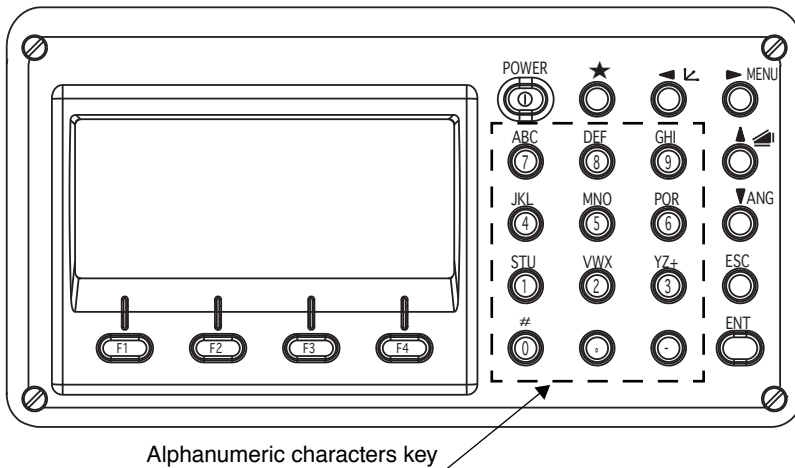

Keys	Name of Key	Function
★	Star key	Star key mode is used for each presetting or displaying as follows. 1 Contrast of the display 2 Reticle illumination 3 Back Light 4 Tilt correction 5 Point guide (Only for point guide model) 6 Set audio mode
	Coordinate meas.key	Coordinate measurement mode
	Distance meas.key	Distance measurement mode.
ANG	Angle meas.key	Angle measurement mode
POWER	Power source key	ON/OFF of power source
MENU	Menu key	Switches menu mode and normal mode. To set application measurements and adjust in the menu mode.
ESC	Escape key	<ul style="list-style-type: none"> <li>● Returning to the measurement mode or previous layer mode from the mode set.</li> <li>● To be DATA COLLECTION mode or LAYOUT mode directly from the normal measurement mode.</li> <li>● It is also possible to use as Record key in normal measurement mode.</li> </ul> <b>To select function of Escape key, see Chapter 16 “SELECTING MODE”</b>
ENT	Enter key	Press at the end of inputting values.
F1-F4	Soft key (Function key)	Responds to the message displayed.

### 1.4 Function Key (Soft Key)

The Soft Key message is displayed at the bottom line of display. The functions are according to the displayed message.

Angle measurement mode

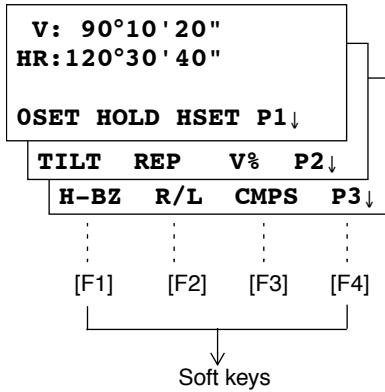

Distance measurement mode

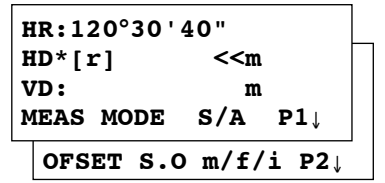

Coordinates measurement mode

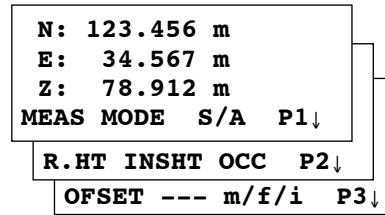

#### Angle measurement

Page	Soft key	Display mark	Function
1	F1	0SET	Angle of Horizontal is set to 0°00'00"
	F2	HOLD	Hold the horizontal angle
	F3	HSET	Sets a required horizontal angle by entering numerals.
	F4	P1↓	The function of soft keys is shown on next page (P2).
2	F1	TILT	Setting Tilt Correction If ON, the display shows tilt correction value.
	F2	REP	Repetition angle measurement mode
	F3	V%	Vertical angle percent grade(%) mode
	F4	P2↓	The function of soft keys is shown on next page (P3).
3	F1	H-BZ	Sets the buzzer sound for every horizontal angle 90°
	F2	R/L	Switches R/L rotation of horizontal angle.
	F3	CMPS	Switches the COMPASS ON/OFF of vertical angle.
	F4	P3↓	The function of soft keys is shown on next page (P1).

#### Distance measurement mode

1	F1	MEAS	Start measuring
	F2	MODE	Sets a measuring mode, Fine/Coarse/Tracking
	F3	S/A	Select set audio mode
	F4	P1↓	The function of soft keys is shown on next page (P2).
2	F1	OFFSET	Select Off-set measurement mode
	F2	S.O	Select stake out measurement mode
	F3	m/f/i	Switches meter, feet or feet and inch unit.
	F4	P2↓	The function of soft keys is shown on next page (P1).

## Coordinate measurement mode

1	F1	MEAS	Start measuring
	F2	MODE	Sets a measuring mode, Fine/Coarse/Tracking
	F3	S/A	Select set audio mode
	F4	P1↓	The function of soft keys is shown on next page (P2).
2	F1	R.HT	Sets a prism height by input values.
	F2	INSHT	Sets an instrument height by input values.
	F3	OCC	Sets an instrument coordinate point by input values.
	F4	P2↓	The function of soft keys is shown on next page (P3).
3	F1	OFSET	Select Off-set measurement mode
	F3	m/f/i	Switches meter, feet or feet and inch unit.
	F4	P3↓	The function of soft keys is shown on next page (P1).

### 1.5 Star key mode

Press the (★) key to view the instrument options.

The following instrument options can be selected from the (★):

1. Adjustment the contrast of the display (0 to 9 steps) [▲ or ▼]
2. Adjustment the reticle illumination (1 to 9 steps) [◀ or ▶]
3. Turn the backlight of the display ON/OFF [F1]
4. Setting Tilt Correction [F2]
5. Turn the Point Guide option ON/OFF [F3] (Only for point guide type)
6. S/A (set audio) mode [F4]

Note: Star key mode does not function when the same function as the function assigned to the star key mode is performed from the main routine.

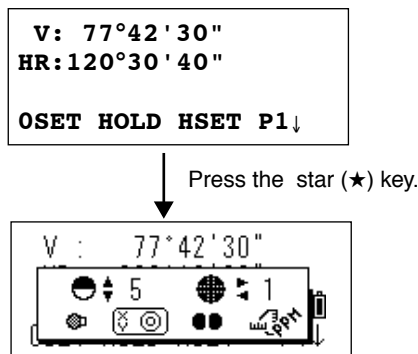

key	Display mark	Function
F1		Turn the backlight of the display ON/OFF
F2		Setting Tilt Correction If ON, the display shows tilt correction value.
F3		Turn the Point Guide option ON/OFF (Only for point guide type)
F4		The light acceptance quantity level for the EDM (SIGNAL), the atmospheric correction value (PPM) and correction value of prism constant (PSM) are displayed.
▲ or ▼		Adjust the contrast of the display (0 to 9 steps)
◀ or ▶		Adjust the Reticle Illumination (1 to 9 steps) ON/OFF of the reticle illumination is linked with ON/OFF of the backlight.

- **Adjustment the contrast (0 to 9) of the display**  
This enable you to adjust the contrast of the display.  
Press the up or down arrow keys to adjust the contrast.
- **Adjustment the reticle illumination (1 to 9)**  
This enable you to adjust the reticle illumination.
- **Turn the display back light ON/OFF**  
To turn the back light ON, press the [F1] key. Press [F1] again to turn the back light OFF.
- **Tilt correction**  
The tilt setting mode performed here will not be memorized after powering OFF. To set TILT correction in the initialized setting ( it is memorized after powering OFF), see Section 6.4.3 "Vertical and Horizontal Angle Tilt correction ( Tilt ON/OFF)" .
- **Set audio mode**  
The light acceptance quantity level (Signal level) is displayed in this mode.  
When reflected light from the prism is received, a buzzer sounds. This function is good for easy collimation when the target is difficult to find.  
Press the [F4] key to view the set audio screen.  
(1) To stop the buzzer, refer to Chapter 16 "SELECTING MODE".  
(2) Also, it is possible to display the signal level in Distance Measuring Mode.  
  
The temperature, pressure, PPM, and PSM can be viewed in set audio mode.  
Refer to Chapter 10 "SET AUDIO MODE", Chapter 11 "SETTING THE PRISM CONSTANT VALUE" and Chapter 12 "SETTING ATMOSPHERIC CORRECTION" , for further instructions.
- **Point guide ( Only for Point guide type)**  
Fast and simple to use, the Point Guide feature is useful when doing stake out work. The LED's for the Point Guide System on the instrument telescope assist the rod person to get on-line. When using the Point Guide System, the battery life will be approximately 8 hours at +20 °C (+68 °F).

#### Turning the Point Guide ON and Operation:

Press the [F3] key to turn ON the Point Guide LEDs.  
Looking at the objective lens of the telescope, the right LED will blink and the left LED will stay lit.

The Point Guide should be used within a distance of 100 meters (328 feet). The quality of its results will depend on the weather conditions and the user's eyesight.

The goal of the rod person is to look at both LED's on the instrument and move the prism on-line until both LED's are equally bright.

If the solid LED is brighter, move right.  
If the blinking LED is brighter, move left.

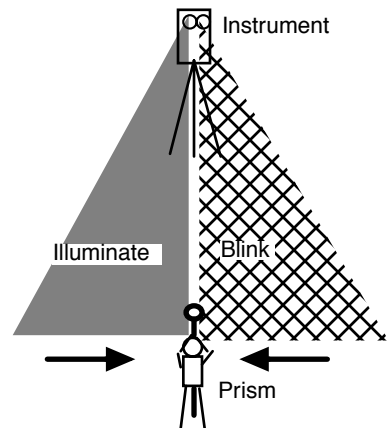

Once you have determined that both of the LED's are equally bright, you are on-line with the instrument.

#### Turning the Point Guide OFF:

To turn OFF the Point Guide System, press the [F3] key again.



## 1.6 Serial signal RS-232C connector

The serial signal connector is used for connecting the GTS-230N series with a computer or TOPCON Data Collector, which enables the computer to receive measured data from the GTS-230N series or to send preset data of horizontal angle, etc. to it.

- The following data will be output at each mode.

Mode	Output
Angle mode ( V,HR or HL)	V,HR (or HL)
Horizontal distance mode (HR, HD, VD)	V,HR, HD, VD
Slope distance mode (V, HR,SD)	V,HR, SD,HD
Coordinate mode	N, E, Z, HR (or V,HR,SD,N,E,Z)

- The display and the output at the coarse mode are the same as the contents above.
- Output at the tracking mode is displayed as distance data only.

The details necessary for the connection with the GTS-230N Series are obtained from its Interface Manual which is optionally available. Please refer to the manual.

## 2 PREPARATION FOR MEASUREMENT

### 2.1 Power Connection

(unnecessary if on-board Ni-MH battery BT-52QA is used)

See below for connecting the external battery pack.

- **Large capacity battery pack BT-3L**  
Power cord PC-6 is used.

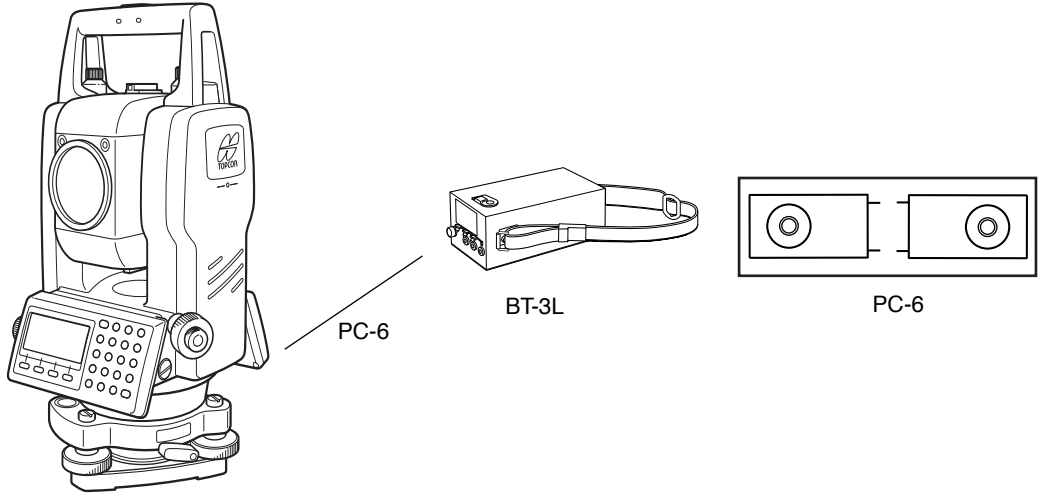

Note: BT-32Q on-board (Ni-cd) battery can be also available.  
To use BT-32Q (Ni-cd) battery, it is required to change battery type in selecting mode, see Section 6.4.5 "Selecting Battery Type".

## 2.2 Setting Instrument Up For Measurement

Mount the instrument to the tripod. Level and center the instrument precisely to insure the best performance. Use tripods with a tripod screw of 5/8 in. diameter and 11 threads per inch, such as the Type E TOPCON wide- frame wooden tripod.

### Reference: Leveling and Centering the Instrument

#### 1. Setting up the Tripod

First, extend the extension legs to suitable lengths and tighten the screws on their midsections.

#### 2. Attaching the Instrument on the Tripod Head

Place the instrument carefully on the tripod head and slide the instrument by loosening the tripod screw. If the plumb bob is positioned right over the center of the point, slightly tighten the tripod screw.

#### 3. Roughly Leveling the Instrument by Using the Circular Level

- 1 Turn the leveling screws A and B to move the bubble in the circular level. The bubble is now located on a line perpendicular to a line running through the centers of the two leveling screws being adjusted.

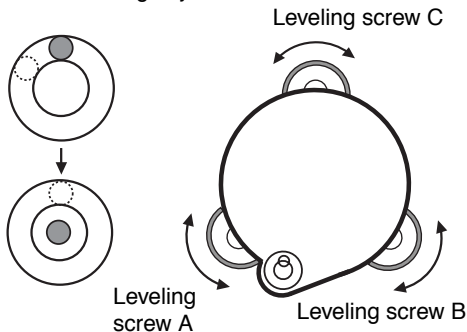

- 2 Turn the leveling screw C to bring the bubble to the center of the circular level.

#### 4. Centering by Using the Plate Level

- 1 Rotate the instrument horizontally by using the Horizontal motion/clamp screw and place the plate level parallel with the line connecting leveling screws A and B, and then bring the bubble to the center of the plate level by turning leveling screws A and B.

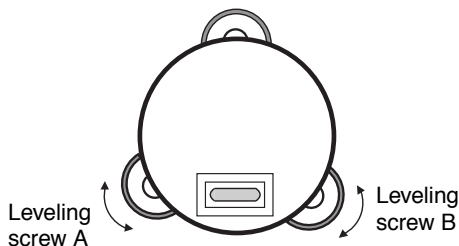

- 2 Rotate the instrument 90° (100g) around its vertical axis and turn the remaining leveling screw or C to center the bubble once more.

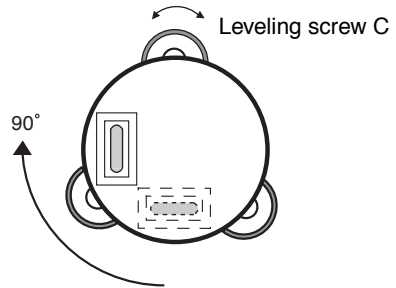

- 3 Repeat the procedures 1 and 2 for each 90° (100g) rotation of the instrument and check whether the bubble is correctly centered for all four points.

#### 5. Centering by Using the Optical Plummet Telescope

Adjust the eyepiece of the optical plummet telescope to your eyesight.

Slide the instrument by loosening the tripod screw, place the point on the center mark, and then tighten the tripod screw. Sliding the instrument carefully not to rotate that allows you to get the least dislocation of the bubble.

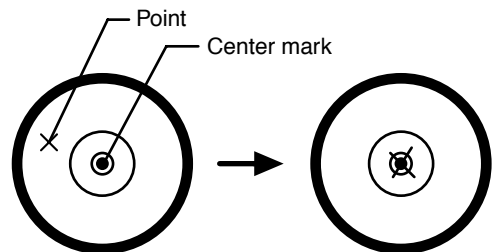

#### 6. Completely Leveling the Instrument

Leveling the instrument precisely in a similar way to 4. Rotate the instrument and check to see that the bubble is in the center of the plate level regardless of telescope direction, then tighten the tripod screw hard.

## 2.3 Power Switch Key ON

- 1 Confirm the instrument is leveled.
- 2 Turn the power switch ON.

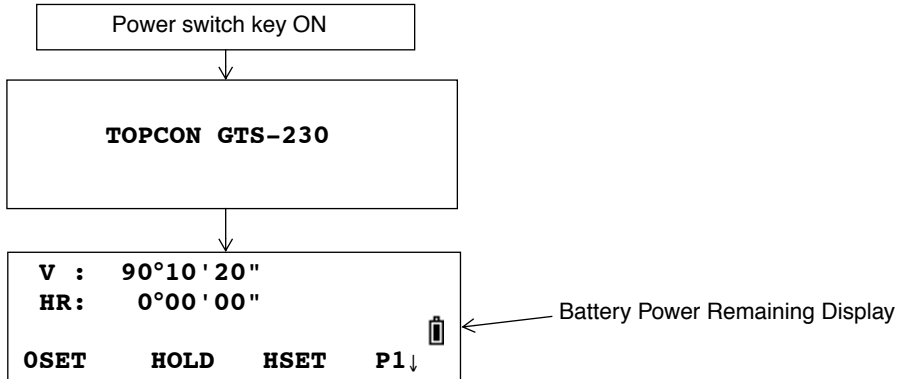

- Confirm the battery power remaining display. Replace with charged battery or charge when battery level is low or indicates “Battery empty”. see Section 2.4 “Battery Power Remaining Display” .
- **Contrast adjustment**  
You can confirm prism constant value (PSM) , atmospheric correction value (PPM) and you can also adjust the contrast of the display when the instrument is turned on.  
To display this screen, see Chapter 16 “SELECTING MODE” ..

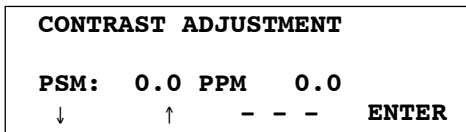

This enables you to adjust the brightness by pressing the [F1](↓) or [F2](↑) key.  
To memorize the setting value after powering off, press [F4](ENTER) key.

## 2.4 Battery Power Remaining Display

Battery power remaining display indicates the power condition.

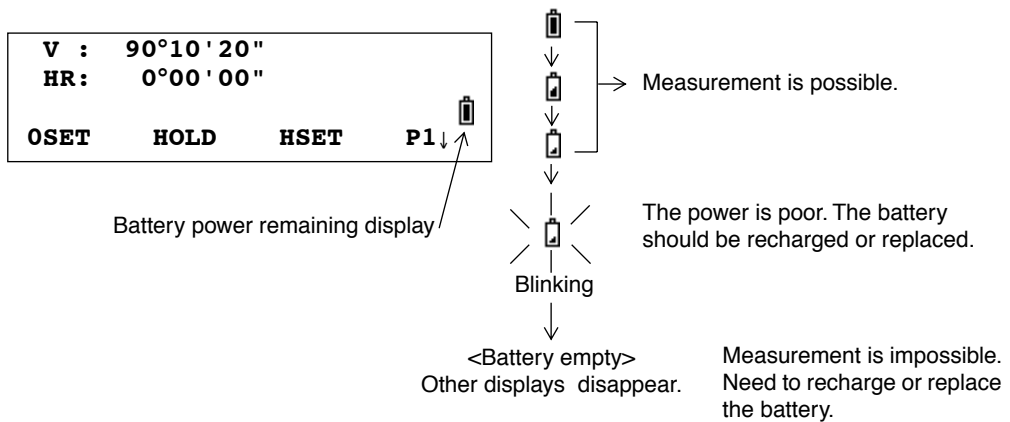

- Note:
- 1 The battery operating time will vary depending on the environmental conditions such as ambient temperature, charging time, the number of times of charging and discharging etc. It is recommended for safety to charge the battery beforehand or to prepare spare full charged batteries.
  - 2 For general usage of the battery, see Chapter 14 "POWER SOURCE AND CHARGING".
  - 3 The battery power remaining display shows the power level regarding to the measurement mode now operating. The safety condition indicated by the battery power remaining display in the angle measurement mode does not necessarily assure the battery's ability to be used in the distance measurement mode. It may happen that the mode change from the angle mode to the distance mode will stop the operation because of insufficient battery power for the distance mode which consumes more power than angle mode.

## 2.5 Vertical and Horizontal Angle Tilt Correction

(GTS-239N has vertical angle tilt correction only.)

When the tilt sensors are activated, automatic correction of vertical and horizontal angle for mislevelment is displayed.

To ensure a precise angle measurement, tilt sensors must be turned on. The display can also be used to fine level the instrument. If the (TILT OVER) display appears the instrument is out of automatic compensation range and must be leveled manually.

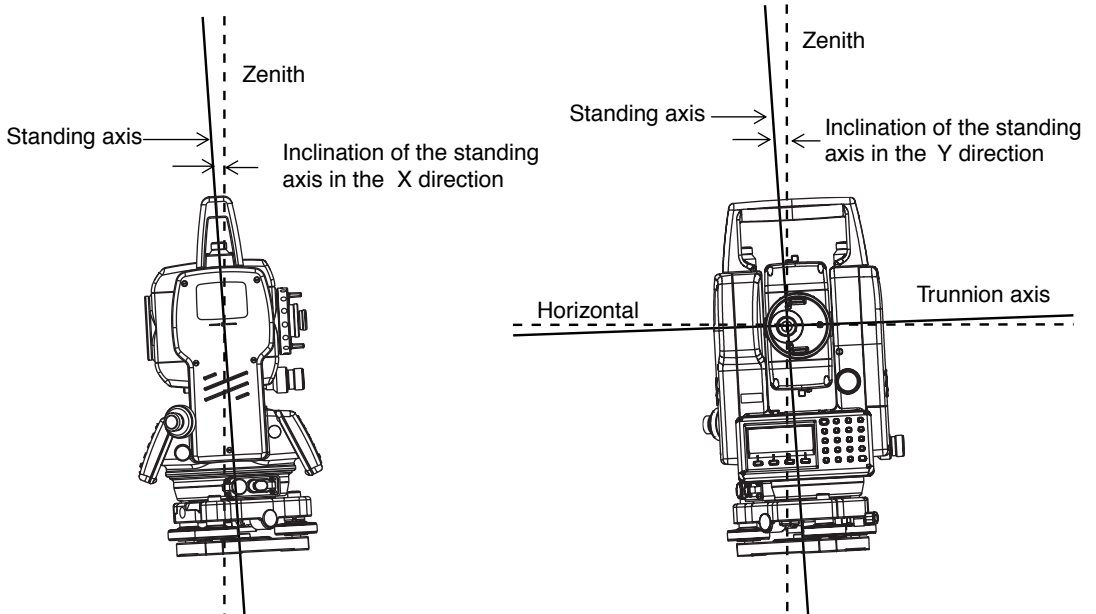

- GTS-230N compensates both the vertical angle and the horizontal angle readings due to inclination of the standing axis in the X and Y directions.
- For more information about dual axis compensation, refer to APPENDIX 1 "Dual Axis Compensation".

When the instrument is out of compensation. (TILT OVER)

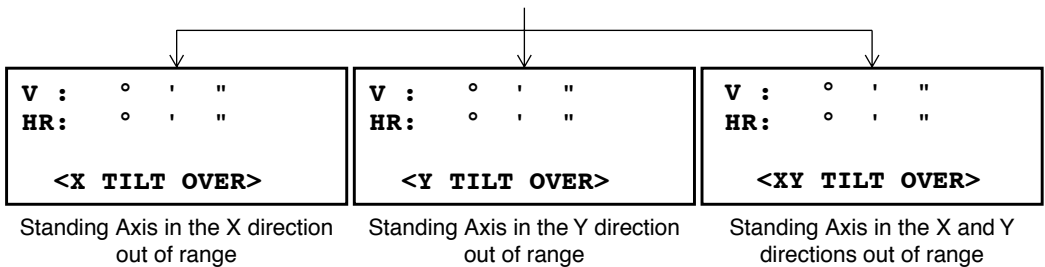

- To set auto tilt correction from the moment that power is on, see Section 6.4.3 "Vertical and Horizontal Angle Tilt correction (Tilt ON/OFF)".
- The display of Vertical or Horizontal angle is unstable when instrument is on an unstable stage or a windy day. You can turn off the auto tilt correction function of V/H angle in this case.

● **Setting Tilt Correction by Soft Key**

To enable you to select tilt ON/OFF function. setting is not memorized after power is OFF.

[Example] Setting X,Y Tilt OFF

Operating procedure	Option	Display
<p><b>1</b> Press [F4] key to get the function page 2.</p>	[F4]	<pre> V : 90°10'20" HR: 120°30'40"  OSET  HOLD  HSET  P1↓ TILT  REP   V%   P2↓                     </pre>
<p><b>2</b> Press [F1](TILT) key. In case ON is already selected, the display shows tilt correction value.</p>	[F1]	<pre> TILT SENSOR:[XY-ON] X:-0°00'25" Y: 0°00'20" X-ON XY-ON OFF ---                     </pre>
<p><b>3</b> Press [F3](OFF) key.</p>	[F3]	<pre> TILT SENSOR: [OFF]  X-ON XY-ON OFF ---                     </pre>
<p><b>4</b> Press [ESC] key.</p>	[ESC]	<pre> V : 90°10'20" HR: 120°30'40"  OSET  HOLD  HSET  P1↓                     </pre>
<p>● The setting mode performed here will not be memorized after powering OFF. To set TILT correction in the initialized setting ( it is memorized after powering OFF), see Section 6.4.3“Vertical and Horizontal Angle Tilt correction ( Tilt ON/OFF)” .</p>		





- 2** Press the [F1] (INPUT) key.  
The arrow changes to the equal (=) .  
The instrument switches to numerical input mode.
- ```
PT#   =
ID    :
INS.HT: 0.000 m
[ALP] [SPC] [CLR] [ENT]
```
- 3** Press the [F1] [ALP] key.  
The instrument switches to alphabetical input mode.
- ```
PT#   =
ID    :
INS.HT: 0.000 m
[NUM] [SPC] [CLR] [ENT]
```
- 4** Enter letters of the alphabet by pressing the alphanumeric characters key.  
Example: [1] (STU) key is pressed twice.
- ```
PT#   =T
ID    :
INS.HT: 0.000 m
[NUM] [SPC] [CLR] [ENT]
```
- 5** Enter other letters of the alphabet in the same way.
- ```
PT#   =TOPCON
ID    :
INS.HT: 0.000 m
[NUM] [SPC] [CLR] [ENT]
```
- 6** Press the [F1] (NUM) key, again.  
The instrument switches back to numerical input mode.
- ```
PT#   =TOPCON
ID    :
INS.HT: 0.000 m
[ALP] [SPC] [CLR] [ENT]
```
- 7** Enter numbers by pressing the alphanumeric characters key.  
Example: [-], [1] key is pressed.
- ```
PT#   =TOPCON-1
ID    :
INS.HT: 0.000 m
[ALP] [SPC] [CLR] [ENT]
```
- 8** Press [F4](ENT) key.  
The arrow moves to next item.  
Select next character in the same manner.
- ```
PT#   =TOPCON-1
ID    →
INS.HT: 0.000 m
[NUM] [SPC] [CLR] [ENT]
```
- To correct a character, move the cursor to correct character by pressing [◀] or [▶] key and enter again.

### 3 ANGLE MEASUREMENT

#### 3.1 Measuring Horizontal Angle Right and Vertical Angle

Make sure the mode is in Angle measurement.

| Operating procedure                                                                                                | Operation   | Display                                                                        |
|--------------------------------------------------------------------------------------------------------------------|-------------|--------------------------------------------------------------------------------|
| <b>1</b> Collimate the 1st target (A).                                                                             | Collimate A | <b>V : 90°10'20"</b><br><b>HR: 120°30'40"</b><br><br><b>OSET HOLD HSET P1↓</b> |
| <b>2</b> Set horizontal angle of target A at 0° 00' 00".<br>Press the [F1](0 set) key and press the [F3](YES) key. | [F1]        | <b>H ANGLE 0 SET</b><br><b>&gt; OK?</b><br><br><b>--- --- [YES] [NO]</b>       |
|                                                                                                                    | [F3]        | <b>V : 90°10'20"</b><br><b>HR: 0°00'00"</b><br><br><b>OSET HOLD HSET P1↓</b>   |
| <b>3</b> Collimate the 2nd target (B).<br>The required V/H angle to target B will be displayed.                    | Collimate B | <b>V : 98°36'20"</b><br><b>HR: 160°40'20"</b><br><br><b>OSET HOLD HSET P2↓</b> |

#### Reference : How to Collimate

- 1 Point the telescope toward the light. Turn the diopter ring and adjust the diopter so that the cross hairs are clearly observed.  
(Turn the diopter ring toward you first and then backward to focus.)
- 2 Aim the target at the peak of the triangle mark of the sighting collimator. Allow a certain space between the sighting collimator and yourself for collimating.
- 3 Focus the target with the focusing knob.

\*If parallax is created between the cross hairs and the target when viewing vertically or horizontally while looking into the telescope, focusing is incorrect or diopter adjustment is poor. This adversely affects precision in measurement or survey. Eliminate the parallax by carefully focusing and using diopter adjustment.

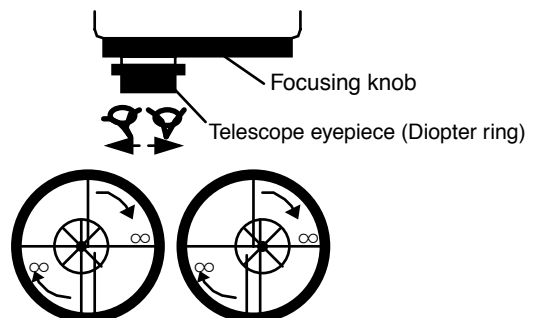

## 3.2 Switching Horizontal Angle Right/Left

Make sure the mode is Angle measurement.

| Operating procedure                                                                                             | Operation     | Display                                                                                                                                                                                                                                                                                                                                                                                                                      |
|-----------------------------------------------------------------------------------------------------------------|---------------|------------------------------------------------------------------------------------------------------------------------------------------------------------------------------------------------------------------------------------------------------------------------------------------------------------------------------------------------------------------------------------------------------------------------------|
| <b>1</b> Press the [F4](↓) key twice to get the function on page 3.                                             | [F4]<br>twice | <div style="border: 1px solid black; padding: 5px;"> <b>V : 90°10'20"</b><br/> <b>HR: 120°30'40"</b> </div> <div style="border: 1px solid black; padding: 5px; margin-top: 5px;"> <b>OSET HOLD HSET P1↓</b> </div> <div style="border: 1px solid black; padding: 5px; margin-top: 5px;"> <b>TILT REP V% P2↓</b> </div> <div style="border: 1px solid black; padding: 5px; margin-top: 5px;"> <b>H-BZ R/L CMPS P3↓</b> </div> |
| <b>2</b> Press the [F2](R/L) key.<br>The mode Horizontal angle Right (HR) switches to Left (HL) mode.           | [F2]          | <div style="border: 1px solid black; padding: 5px;"> <b>V : 90°10'20"</b><br/> <b>HL: 239°29'20"</b> </div> <div style="border: 1px solid black; padding: 5px; margin-top: 5px;"> <b>H-BZ R/L CMPS P3↓</b> </div>                                                                                                                                                                                                            |
| <b>3</b> Measure as HL mode.                                                                                    |               |                                                                                                                                                                                                                                                                                                                                                                                                                              |
| <ul style="list-style-type: none"> <li>● Every time pressing the [F2](R/L) key, HR/HL mode switches.</li> </ul> |               |                                                                                                                                                                                                                                                                                                                                                                                                                              |

## 3.3 Measuring from the Required Horizontal Angle

### 3.3.1 Setting by Holding the Angle

Make sure the mode is angle measurement.

| Operating procedure                                                                                                                     | Operation     | Display                                                                                                                                                                                                            |
|-----------------------------------------------------------------------------------------------------------------------------------------|---------------|--------------------------------------------------------------------------------------------------------------------------------------------------------------------------------------------------------------------|
| <b>1</b> Set the required horizontal angle, using Horizontal tangent screw.                                                             | Display angle | <div style="border: 1px solid black; padding: 5px;"> <b>V : 90°10'20"</b><br/> <b>HR: 130°40'20"</b> </div> <div style="border: 1px solid black; padding: 5px; margin-top: 5px;"> <b>OSET HOLD HSET P1↓</b> </div> |
| <b>2</b> Press the [F2](HOLD) key.                                                                                                      | [F2]          | <div style="border: 1px solid black; padding: 5px;"> <b>H ANGLE HOLD</b><br/> <b>HR= 130°40'20"</b><br/> <b>&gt; SET ?</b><br/> <b>--- --- [YES] [NO]</b> </div>                                                   |
| <b>3</b> Collimate the target.                                                                                                          | Collimate     |                                                                                                                                                                                                                    |
| <b>4</b> Press the [F3](YES) key to finish holding the horizontal angle.*1)<br>The display turns back to normal angle measurement mode. | [F3]          | <div style="border: 1px solid black; padding: 5px;"> <b>V : 90°10'20"</b><br/> <b>HR: 130°40'20"</b> </div> <div style="border: 1px solid black; padding: 5px; margin-top: 5px;"> <b>OSET HOLD HSET P1↓</b> </div> |
| <p>*1) To return to the previous mode, press the [F4](NO) key.</p>                                                                      |               |                                                                                                                                                                                                                    |

### 3.3.2 Setting a Horizontal Angle from the Keys

Make sure the mode is Angle measurement.

| Operating procedure                                                                                                                                                                   | Operation               | Display                                                                                                  |
|---------------------------------------------------------------------------------------------------------------------------------------------------------------------------------------|-------------------------|----------------------------------------------------------------------------------------------------------|
| <b>1</b> Collimate the target.                                                                                                                                                        | Collimate               | <b>V : 90°10'20"</b><br><b>HR: 170°30'20"</b><br><br><b>OSET HOLD HSET P1↓</b>                           |
| <b>2</b> Press the [F3](HSET) key.                                                                                                                                                    | [F3]                    | <b>H ANGLE SET</b><br><b>HR:</b><br><br><b>INPUT --- --- ENTER</b><br><br><b>[---] [---] [CLR] [ENT]</b> |
| <b>3</b> Input the required horizontal angle by using keys. *1)<br><br>For example :70°40'20"<br><br>When completed, normal measuring from the required Horizontal angle is possible. | [F1]<br>70.4020<br>[F4] | <b>V : 90°10'20"</b><br><b>HR: 70°40'20"</b><br><br><b>OSET HOLD HSET P1↓</b>                            |
| *1) To enter Alphanumeric characters, see Section 2.6 "How to Enter Alphanumeric characters".                                                                                         |                         |                                                                                                          |

### 3.4 Vertical Angle Percent Grade(%) Mode

Make sure the mode is Angle measurement.

| Operating procedure                                                                                                                                                                              | Operation | Display                                                                                                      |
|--------------------------------------------------------------------------------------------------------------------------------------------------------------------------------------------------|-----------|--------------------------------------------------------------------------------------------------------------|
| <b>1</b> Press the [F4](↓) key to get the function on page 2.                                                                                                                                    | [F4]      | <b>V : 90°10'20"</b><br><b>HR: 170°30'20"</b><br><br><b>OSET HOLD HSET P1↓</b><br><br><b>TILT REP V% P2↓</b> |
| <b>2</b> Press the [F3](V%) key. *1)                                                                                                                                                             | [F3]      | <b>V : -0.30 %</b><br><b>HR: 170°30'20"</b><br><br><b>TILT REP V% P1↓</b>                                    |
| *1) Every time pressing the [F3](V%) key, the display mode switches.<br>● When the measurement is carried out over $\pm 45^\circ$ ( $\pm 100\%$ ) from the horizontal, the display shows <OVER>. |           |                                                                                                              |



|                                                                                                                                                                                                                                                                                                                                                       |                              |                                                                                                                                         |
|-------------------------------------------------------------------------------------------------------------------------------------------------------------------------------------------------------------------------------------------------------------------------------------------------------------------------------------------------------|------------------------------|-----------------------------------------------------------------------------------------------------------------------------------------|
| <p><b>10</b> To return to the normal angle mode, press the [F2](V/H) key or [ESC] key.</p>                                                                                                                                                                                                                                                            | <p>[ESC]<br/>or<br/>[F2]</p> | <div style="border: 1px solid black; padding: 5px;"> <p><b>REPETITION ANGLE</b><br/>Exit<br/>&gt; OK?<br/>--- --- [YES] [NO]</p> </div> |
| <p><b>11</b> Press the [F3](YES) key.</p>                                                                                                                                                                                                                                                                                                             | <p>[F3]</p>                  | <div style="border: 1px solid black; padding: 5px;"> <p>V : 90°10'20"<br/>HR: 170°30'20"</p> <p><b>OSET HOLD HSET P1↓</b></p> </div>    |
| <ul style="list-style-type: none"> <li>● Horizontal angle can be accumulated up to (3600°00'00" – minimum reading) (horizontal angle right).<br/>In case of 5 second reading, horizontal angle can be accumulated up to +3599°59'55".</li> <li>● Error will be displayed when the results differ from first measurement by more than ±30".</li> </ul> |                              |                                                                                                                                         |

### 3.6 Buzzer Sounding for Horizontal Angle 90° Increments

When the horizontal angle falls in the range of less than ± 1° of 0°, 90°, 180° or 270°, the buzzer sounds. Buzzer stops only when the horizontal angle is adjusted to 0°00'00", 90°00'00", 180°00'00" or 270°00'00".

This setting is not memorized after powering off. Refer to 16 "SELECTING MODE" to set the initial setting (memorized after powering off).

Make sure the mode is Angle measurement.

| Operating procedure                                                                  | Operation             | Display                                                                                                                                                              |
|--------------------------------------------------------------------------------------|-----------------------|----------------------------------------------------------------------------------------------------------------------------------------------------------------------|
| <p><b>1</b> Press the [F4](↓) key twice to get the function on page 3.</p>           | <p>[F4]<br/>twice</p> | <div style="border: 1px solid black; padding: 5px;"> <p>V : 90°10'20"<br/>HR: 170°30'20"</p> <p><b>OSET HOLD HSET P1↓</b></p> <p><b>H-BZ R/L CMPS P3↓</b></p> </div> |
| <p><b>2</b> Press the [F1](H-BZ) key.<br/>The data previously set is shown.</p>      | <p>[F1]</p>           | <div style="border: 1px solid black; padding: 5px;"> <p><b>H-ANGLE BUZZER [OFF]</b></p> <p>[ON] [OFF] --- ENTER</p> </div>                                           |
| <p><b>3</b> Press the [F1](ON) key or [F2](OFF) key to select the buzzer ON/OFF.</p> | <p>[F1] or [F2]</p>   | <div style="border: 1px solid black; padding: 5px;"> <p><b>H-ANGLE BUZZER [ON]</b></p> <p>[ON] [OFF] --- ENTER</p> </div>                                            |
| <p><b>4</b> Press the [F4](ENTER) key.</p>                                           | <p>[F4]</p>           | <div style="border: 1px solid black; padding: 5px;"> <p>V : 90°10'20"<br/>HR: 170°30'20"</p> <p><b>OSET HOLD HSET P1↓</b></p> </div>                                 |

### 3.7 Compasses ( vertical angle)

Vertical angle is displayed as shown below.

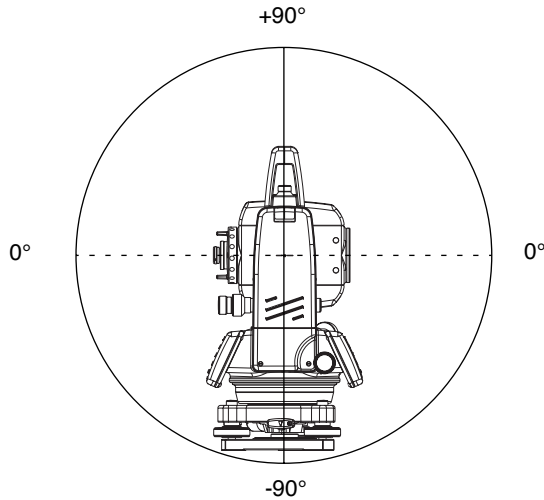

| Operating procedure                                                                                                      | Operation                         | Display                                                                                                                                                                                                                                                                                                                                                |
|--------------------------------------------------------------------------------------------------------------------------|-----------------------------------|--------------------------------------------------------------------------------------------------------------------------------------------------------------------------------------------------------------------------------------------------------------------------------------------------------------------------------------------------------|
| <p><b>1</b> Press the [F4](↓) key twice to get the function on page 3.</p> <p><b>2</b> Press the [F3](CMPS) key. *1)</p> | <p>[F4]<br/>twice</p> <p>[F3]</p> | <div style="border: 1px solid black; padding: 5px;"> <p><b>V : 98°10'20"</b><br/><b>HR: 170°30'20"</b></p> <p><b>OSET HOLD HSET P1↓</b></p> <p><b>H-BZ R/L CMPS P3↓</b></p> </div> <div style="border: 1px solid black; padding: 5px; margin-top: 5px;"> <p><b>V : - 8°10'20"</b><br/><b>HR: 170°30'20"</b></p> <p><b>H-BZ R/L CMPS P3↓</b></p> </div> |
| <p>*1) Every time pressing the [F3](CMPS) key, the display mode switches.</p>                                            |                                   |                                                                                                                                                                                                                                                                                                                                                        |

## 4 DISTANCE MEASUREMENT

### 4.1 Setting of the Atmospheric Correction





When setting the atmospheric correction, obtain the correction value by measuring the temperature and pressure. Refer to Section 12.2 "Setting of Atmospheric Correction Value".

### 4.2 Setting of the Correction for Prism Constant

Topcon's prism constant value is 0. Set correction for prism at 0. If the prism is of another manufacture, the appropriate constant shall be set beforehand. Refer to Chapter 11 "SETTING THE PRISM CONSTANT VALUE". The setting value is kept in the memory even after power is off.

### 4.3 Distance Measurement (Continuous Measurement)

Make sure the mode displays angle measurement.

| Operating procedure                                                                                                                                                                                                                                                                                                                                                                                                                                                                                                                                                                                                                                                                                                                                                                                                                                                            | Operation                                                                               | Display                                                                                                                                                             |
|--------------------------------------------------------------------------------------------------------------------------------------------------------------------------------------------------------------------------------------------------------------------------------------------------------------------------------------------------------------------------------------------------------------------------------------------------------------------------------------------------------------------------------------------------------------------------------------------------------------------------------------------------------------------------------------------------------------------------------------------------------------------------------------------------------------------------------------------------------------------------------|-----------------------------------------------------------------------------------------|---------------------------------------------------------------------------------------------------------------------------------------------------------------------|
| 1 Collimate the center of prism.                                                                                                                                                                                                                                                                                                                                                                                                                                                                                                                                                                                                                                                                                                                                                                                                                                               | Collimate P                                                                             | <div style="border: 1px solid black; padding: 5px;"> <b>V : 90°10'20"</b><br/> <b>HR: 120°30'40"</b><br/><br/> <b>OSET HOLD HSET P1↓</b> </div>                     |
| 2 Press the [  ] key.<br>Distance measurement starts. *1),2)                                                                                                                                                                                                                                                                                                                                                                                                                                                                                                                                                                                                                                                                                                                                  | [  ]   | <div style="border: 1px solid black; padding: 5px;"> <b>HR: 120°30'40"</b><br/> <b>HD* [r] &lt;&lt; m</b><br/> <b>VD: m</b><br/> <b>MEAS MODE S/A P1↓</b> </div>    |
| The measured distances are shown. *3)~*5)                                                                                                                                                                                                                                                                                                                                                                                                                                                                                                                                                                                                                                                                                                                                                                                                                                      |                                                                                         | ↓                                                                                                                                                                   |
|                                                                                                                                                                                                                                                                                                                                                                                                                                                                                                                                                                                                                                                                                                                                                                                                                                                                                |                                                                                         | <div style="border: 1px solid black; padding: 5px;"> <b>HR: 120°30'40"</b><br/> <b>HD* 123.456 m</b><br/> <b>VD: 5.678 m</b><br/> <b>MEAS MODE S/A P1↓</b> </div>   |
| ● Pressing the [  ] key again, the display changes to horizontal (HR) and vertical (V) angle and slope distance(SD). *6)                                                                                                                                                                                                                                                                                                                                                                                                                                                                                                                                                                                                                                                                    | [  ] | <div style="border: 1px solid black; padding: 5px;"> <b>V : 90°10'20"</b><br/> <b>HR: 120°30'40"</b><br/> <b>SD* 131.678 m</b><br/> <b>MEAS MODE S/A P1↓</b> </div> |
| <p>*1) When EDM is working, the "※" mark appears in the display.</p> <p>*2) To change mode from Fine to Coarse or Tracking, refer to section 4.5 "Fine Mode/Tracking Mode/Coarse Mode".<br/>To set the distance measurement when the instrument is powered on, refer to Chapter 16 "SELECTING MODE".</p> <p>*3) The distance unit indicator "m" (for meter), "f" (for feet or feet inch) appears and disappears alternatively with buzzer sounds at every renewal of distance data.</p> <p>*4) Measurement may repeat automatically in the instrument if the result is affected by shimmer etc..</p> <p>*5) To return to the normal measuring angle mode from a distance measuring mode, press the [ANG] key.</p> <p>*6) It is possible to choose the display order (HR, HD, VD) or (V, HR, SD) for initial measuring distance mode. Refer to Chapter 16 "SELECTING MODE".</p> |                                                                                         |                                                                                                                                                                     |





## 4.4 Distance Measurement (N-time Measurement/Single Measurement)

When the number of times measurement is preset, the GTS-230N series measures the distance the set number of times. The average distance will be displayed.

When presetting the number of times as 1, it does not display the average distance, because of single measurement. Single measurement is set at the factory.

Make sure the mode displays angle measurement.

| Operating procedure                                                                                                                                                                                                                                                                                 | Operation                                                                             | Display                                                                                                    |
|-----------------------------------------------------------------------------------------------------------------------------------------------------------------------------------------------------------------------------------------------------------------------------------------------------|---------------------------------------------------------------------------------------|------------------------------------------------------------------------------------------------------------|
| <b>1</b> Collimate the center of prism.                                                                                                                                                                                                                                                             |                                                                                       | <pre>V : 90°10'20" HR: 120°30'40"  OSET HOLD HSET P1↓</pre>                                                |
| <b>2</b> Press the [  ] key.<br>Continuous measuring starts.*1)                                                                                                                                                    | [  ] | <pre>HR: 120°30'40" HD* [r] &lt;&lt; m VD: m MEAS MODE S/A P1↓</pre>                                       |
| <b>3</b> Press [F1](MEAS) key while continuous measuring is exceeding.*2)<br><br>The average value is displayed and "*" mark disappears.                                                                                                                                                            | [F1]                                                                                  | <pre>HR: 120°30'40" HD* [n] &lt;&lt; m VD: m MEAS MODE S/A P1↓</pre>                                       |
| ● While EDM is working, press [F1](MEAS) key again, the mode will be changed to continuous measuring mode.                                                                                                                                                                                          |                                                                                       | <p style="text-align: center;">↓</p> <pre>HR: 120°30'40" HD: 123.456 m VD: 5.678 m MEAS MODE S/A P1↓</pre> |
| <p>*1) It is possible to set the measurement mode for N-times measurement mode or continuous measurement mode when the power is turned on. Refer to Chapter 16 "SELECTING MODE".</p> <p>*2) For setting the number of times (N-times) in the measurement, refer to Chapter 16 "SELECTING MODE".</p> |                                                                                       |                                                                                                            |

● **Choose meter /feet / feet+inch unit by soft key**

It is possible to change the unit for distance measurement mode by soft key.

This setting is not memorized after power off. Refer to 16 "SELECTING MODE" to set at the initial setting (memorized after power off).

| Operating procedure                                                                                                                                                                                                             | Operation | Display                                                                                  |
|---------------------------------------------------------------------------------------------------------------------------------------------------------------------------------------------------------------------------------|-----------|------------------------------------------------------------------------------------------|
| <b>1</b> Press the [F4](P1↓) key to get the function on page 2<br><br><b>2</b> Every time pressing the [F3](m/f/i) key, the display unit will be changed.<br>● Every time pressing the [F3](m/f/i) key, the unit mode switches. | [F4]      | HR: 120°30'40"<br>HD* 2.000 m<br>VD: 3.000 m<br>MEAS MODE S/A P1↓<br>OFSET S.O m/f/i P2↓ |
|                                                                                                                                                                                                                                 | [F3]      | HR: 120°30'40"<br>HD* 6.560 f<br>VD: 9.845 f<br>OFSET S.O m/f/i P2↓                      |

**4.5 Fine Mode/Tracking Mode/Coarse Mode**

This setting is not memorized after power is off. Refer to Chapter 16"SELECTING MODE" to set at the initial setting (memorized after power is off).

- Fine Mode : This is a normal distance measuring mode.  
 The unit to be displayed: 0.2mm or 1mm. (0.001ft or 0.005ft)  
 Measurement time 0.2mm mode: approx. 2.8 sec.  
 1mm mode: approx. 1.2 sec.
- Tracking Mode : This mode measures in shorter time than in fine mode.  
 It is very useful when tailing the moving object or carrying out stake-out work.  
 The unit to be displayed: 10mm  
 Measuring time: approx. 0.4 sec.
- Coarse Mode : This mode measures in shorter time than in fine mode.  
 The unit to be displayed: 10mm or 1mm  
 Measuring time: approx. 0.7 sec.

| Operating procedure                                                                                                                                                                                                                                   | Operation | Display                                                                                  |
|-------------------------------------------------------------------------------------------------------------------------------------------------------------------------------------------------------------------------------------------------------|-----------|------------------------------------------------------------------------------------------|
| <b>1</b> Press the [F2](MODE) key from the distance measuring mode.*1)<br><br>The initial character (F/T/C) of set mode is displayed . (F:Fine, T:Tracking, C:Coarse)<br><br><b>2</b> Press the [F1](FINE) key, [F2](TRACK) key, or [F3](COARSE) key. | [F2]      | HR: 120°30'40"<br>HD* 123.456m<br>VD: 5.678m<br>MEAS MODE S/A P1↓<br>FINE TRACK COARSE F |
|                                                                                                                                                                                                                                                       | [F1]~[F3] | HR: 120°30'40"<br>HD* 123.456m<br>VD: 5.678m<br>MEAS MODE S/A P1↓                        |
|                                                                                                                                                                                                                                                       |           |                                                                                          |
| *1) To cancel the setting, press the [ESC] key.                                                                                                                                                                                                       |           |                                                                                          |

## 4.6 Stake Out (S.O)

The difference between the measured distance and the input stake out distance is displayed.

**Measured distance – Stake out distance = Displayed value**

- In stake out operation, you can select either horizontal distance (HD), relative elevation (VD) and slope distance (SD)

| Operating procedure                                                                                                                                                                                                           | Operation                  | Display                                                                                                                                                                                                        |
|-------------------------------------------------------------------------------------------------------------------------------------------------------------------------------------------------------------------------------|----------------------------|----------------------------------------------------------------------------------------------------------------------------------------------------------------------------------------------------------------|
| <b>1</b> Press the [F4](↓) key in the distance measuring mode to get the function on page 2.                                                                                                                                  | [F4]                       | <pre> HR: 120°30'40" HD*   123.456 m VD:   5.678 m MEAS MODE S/A P1↓ OFSET S.O m/f/i P2↓ </pre>                                                                                                                |
| <b>2</b> Press the [F2](S.O) key.<br><br>The data previously set is shown.                                                                                                                                                    | [F2]                       | <pre> STAKE OUT HD : 0.000 m  HD  VD  SD  --- </pre>                                                                                                                                                           |
| <b>3</b> Select the measuring mode by pressing the [F1] to [F3] key.<br><br>Example : Horizontal distance                                                                                                                     | [F1]                       | <pre> STAKE OUT HD : 0.000 m  INPUT --- --- ENTER [---] [---] [CLR] [ENT] </pre>                                                                                                                               |
| <b>4</b> Enter the distance for stake out. *1)                                                                                                                                                                                | [F1]<br>Enter data<br>[F4] | <pre> STAKE OUT HD : 100.000 m  INPUT --- --- ENTER </pre>                                                                                                                                                     |
| <b>5</b> Collimate the target (Prism).<br><br>Measuring starts.<br><br>The difference between the measured distance and the stake out distance is displayed.                                                                  | Collimate P                | <pre> HR: 120°30'40" dHD* [r]          &lt;&lt; m VD:              m MEAS MODE S/A P1↓ </pre> <p style="text-align: center;">↓</p> <pre> HR: 120°30'40" dHD*   23.456 m VD:   5.678 m MEAS MODE S/A P1↓ </pre> |
| <b>6</b> Move the target until the difference becomes 0m.                                                                                                                                                                     |                            |                                                                                                                                                                                                                |
| <p>*1) Refer to section 2.6 "How to Enter Alphanumeric characters".</p> <ul style="list-style-type: none"> <li>● To return to normal distance measurement mode, stake out distance to "0" m or turn the power off.</li> </ul> |                            |                                                                                                                                                                                                                |

## 4.7 Offset Measurement

There are four offset measurement modes in the Offset Measurement.

- Angle offset
- Distance offset
- Plane offset
- Column offset

To show the offset measurement menu, press the [OFSET] soft key from distance or coordinate measurement mode.

Example:

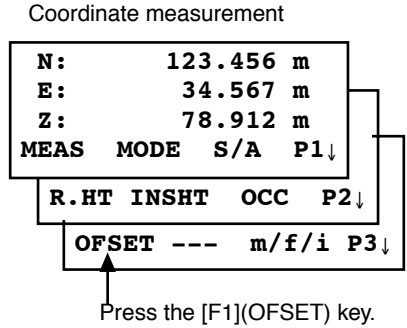
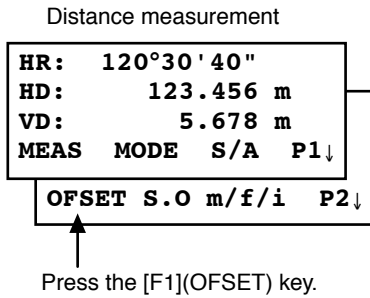

Offset Measurement Menu

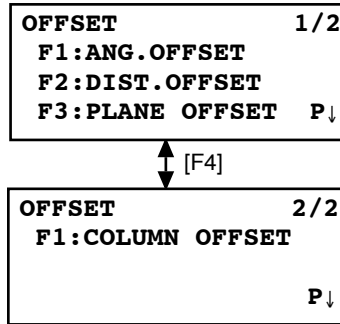

### ● Outputting the Measurement Data

The results of offset measurement can be output to external device.

Setting the function of the [ESC] key to (REC), the [F3] soft key which assigned (REC) will appear in measured result display.

Refer to Chapter 16 "SELECTING MODE" to set this option.

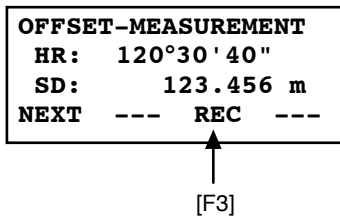

### ● Distance measurement mode of the offset measurement

Offset measurement will be done by N-time fine measurement mode.

For setting measuring times refer to Chapter 16 "SELECTING MODE".

### 4.7.1 Angle Offset

This mode is useful when it is difficult to set up the prism directly, for example at the center of a tree. Place the prism at the same horizontal distance from the instrument as that of point A<sub>0</sub> to measure. To measure the coordinates of the center position, operate the offset measurement after setting the instrument height/prism height.

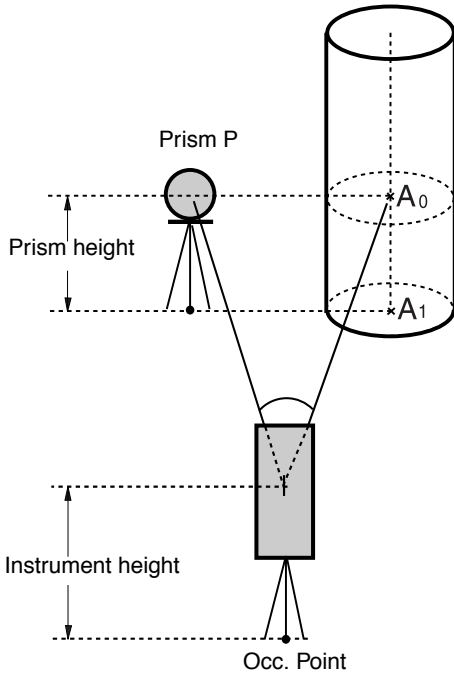

When measuring coordinates of ground point A<sub>1</sub> :Set the instrument height/prism height.

When measuring coordinates of point A<sub>0</sub> : Set the instrument height only. (Set the prism height to 0 ).

When sighting to A<sub>0</sub>, you can select one of two ways. One is to fix vertical angle to the prism position even updown the telescope position, and the other is to gear vertical angle to the updown of telescope movement. In case following the vertical angle to the movement of telescope, SD(Slope Distance) and VD(Vertical Distance) will be changed according to the movement of telescope.  
To set this option, refer to Chapter 16 "SELECTING MODE".

- Set the instrument height/prism height before proceeding to the offset measurement mode.
- When setting the coordinate value for the occupied station, refer to Section 5.1 "Setting Coordinate Values of Occupied Point"..

| Operating procedure                                                                          | Operation           | Display                                                                                                                                    |
|----------------------------------------------------------------------------------------------|---------------------|--------------------------------------------------------------------------------------------------------------------------------------------|
| <b>1</b> Press the [F4](P1↓) key from distance measuring mode to get the function on page 2. | [F4]                | <pre> HR: 120°30'40" HD: 123.456 m VD: 5.678 m MEAS MODE S/A P1↓ OFFSET S.0 m/f/i P2↓                     </pre>                           |
| <b>2</b> Press the [F1](OFFSET) key.                                                         | [F1]                | <pre> OFFSET 1/2 F1:ANG.OFFSET F2:DIST.OFFSET F3:PLANE OFFSET P1↓                     </pre>                                               |
| <b>3</b> Press the [F1](ANG. OFFSET) key.                                                    | [F1]                | <pre> OFFSET-MEASUREMENT HR: 120°30'40" HD: m MEAS --- --- ---                     </pre>                                                  |
| <b>4</b> Collimate prism P, and press the [F1](MEAS) key.                                    | Collimate P<br>[F1] | <pre> OFFSET-MEASUREMENT HR: 110°20'30" HD*[n] &lt;&lt; m &gt;Measuring...                     </pre> <p style="text-align: center;">↓</p> |

The horizontal distance from the instrument to the prism will be measured.

After measuring, the result added offset value will be shown.

**5** Collimate point A<sub>0</sub> using the horizontal motion clamp and horizontal tangent screw.

Collimate  
A<sub>0</sub>

**6** Show the relative elevation of point A<sub>0</sub>.

[▲]

**7** Show the slope distance of point A<sub>0</sub>.

[▲]

● Each time pressing the [▲] key, horizontal distance, relative elevation and slope distance are shown in sequence.

**8** Show N coordinate of point A<sub>0</sub> or A<sub>1</sub>.

[↙]

● Each time pressing [↙] key, N,E and Z coordinate are shown in sequence.

● To return to procedure **4**, press [F1](NEXT) key.  
● To return to the previous mode, press [ESC] key.

**OFFSET-MEASUREMENT**  
HR: 110°20'30"  
HD\* 56.789 m  
>Measuring...

**OFFSET-MEASUREMENT**  
HR: 110°20'30"  
HD: 56.789 m  
NEXT --- --- ---

**OFFSET-MEASUREMENT**  
HR: 113°30'50"  
HD: 56.789 m  
NEXT --- --- ---

**OFFSET-MEASUREMENT**  
HR: 113°20'30"  
VD: 3.456 m  
NEXT --- --- ---

**OFFSET-MEASUREMENT**  
HR: 113°20'30"  
SD: 56.894 m  
NEXT --- --- ---

**OFFSET-MEASUREMENT**  
HR: 113°20'30"  
N : -12.345 m  
NEXT --- --- ---

### 4.7.2 Distance Offset Measurement

Measuring distance and coordinate of the center of a pond or a tree of which the radius is known. Measuring the distance or coordinate till P0 point, input oHD value as an offset value and measure P1 point showing as following draw in distance offset measurement. The display shows distance or coordinate value until P0 point.

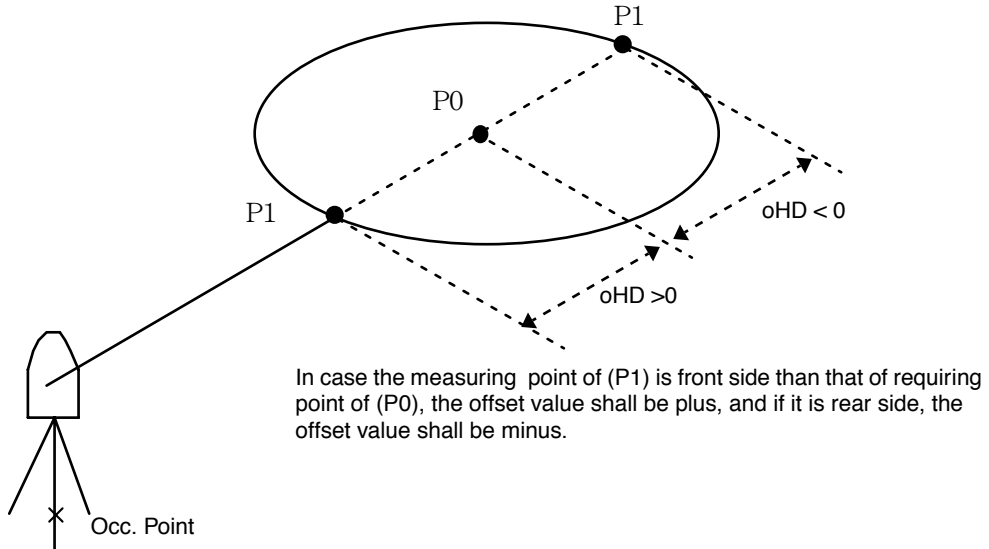

- When setting the coordinate value for the occupied station, refer to Section 5.1 "Setting Coordinate Values of Occupied Point".

| Operating procedure                                                                   | Operation                       | Display                                                                                                             |
|---------------------------------------------------------------------------------------|---------------------------------|---------------------------------------------------------------------------------------------------------------------|
| 1 Press the [F4](P1↓) key from distance measuring mode to get the function on page 2. | [F4]                            | <pre> HR: 120°30'40" HD: 123.456 m VD: 5.678 m MEAS MODE S/A P1↓ OFFSET S.O m/f/i P2↓ </pre>                        |
| 2 Press the [F1](OFFSET) key.                                                         | [F1]                            | <pre> OFFSET 1/2 F1:ANG.OFFSET F2:DIST.OFFSET F3:PLANE OFFSET P↓ </pre>                                             |
| 3 Press the [F2](DIST. OFFSET) key.                                                   | [F2]                            | <pre> DISTANCE OFFSET INPUT FORWARD HD oHD: m INPUT --- --- ENTER </pre>                                            |
| 4 Press the [F1](INPUT) key and enter a offset value, and press the [F4](ENTER) key.  | [F1]<br>Offset<br>value<br>[F4] | <pre> DISTANCE OFFSET HR: 80°30'40" HD: m MEAS --- --- --- </pre>                                                   |
| 5 Collimate prism P1, and press the [F1](MEAS) key. Measuring will start.             | Collimate<br>P1<br>[F1]         | <pre> DISTANCE OFFSET HR: 80°30'40" HD* [n] &lt;&lt; m &gt;Measuring... </pre> <p style="text-align: center;">↓</p> |

After measuring, the result added offset value will be shown.

- 6** Show the relative elevation of point P0.
- Each time pressing the [] key, horizontal distance, relative elevation and slope distance are shown in sequence.

- Show coordinate of point P0.



|                         |
|-------------------------|
| <b>DISTANCE OFFSET</b>  |
| <b>HR:</b> 80°30'40"    |
| <b>HD*</b> 10.000 m     |
| <b>NEXT</b> --- --- --- |

|                         |
|-------------------------|
| <b>DISTANCE OFFSET</b>  |
| <b>HR:</b> 80°30'40"    |
| <b>VD:</b> 11.789 m     |
| <b>NEXT</b> --- --- --- |

|                         |
|-------------------------|
| <b>DISTANCE OFFSET</b>  |
| <b>HR:</b> 80°30'40"    |
| <b>SD:</b> 11.789 m     |
| <b>NEXT</b> --- --- --- |



|                         |
|-------------------------|
| <b>N :</b> 12.345 m     |
| <b>E :</b> 23.345 m     |
| <b>Z :</b> 1.345 m      |
| <b>NEXT</b> --- --- --- |

- To return to procedure **4**, press [F1](NEXT) key.
- To return to the previous mode, press [ESC] key.



### 4.7.3 Plane Offset Measurement

Measuring will be taken for the place where direct measuring can not be done, for example distance or coordinate measuring for an edge of a plane.

Three random prism points (P1, P2, P3) on a plane will be measured at first in the plane offset measurement to determine the measured plane. Collimate the measuring target point (P0) then the instrument calculates and displays coordinate and distance value of cross point between collimation axis and of the plane.

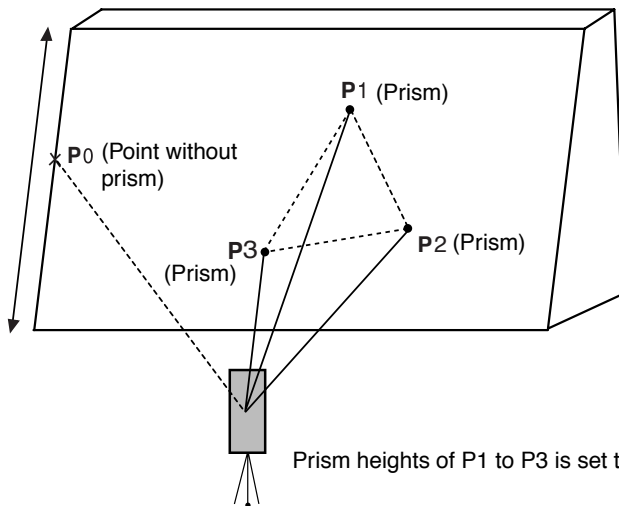

- When setting the coordinate value for the occupied station, refer to Section 5.1 “Setting Coordinate Values of Occupied Point”.

| Operating procedure                                                                                                                                         | Operation            | Display                                                                                                          |
|-------------------------------------------------------------------------------------------------------------------------------------------------------------|----------------------|------------------------------------------------------------------------------------------------------------------|
| 1 Press the [F4](P1↓) key from distance measuring mode to get the function on page 2.                                                                       | [F4]                 | <pre> HR: 120°30'40" HD: 123.456 m VD: 5.678 m MEAS MODE S/A P1↓ OFFSET S.0 m/f/i P2↓                     </pre> |
| 2 Press the [F1](OFFSET) key.                                                                                                                               | [F1]                 | <pre> OFFSET 1/2 F1:ANG.OFFSET F2:DIST.OFFSET F3:PLANE OFFSET P↓                     </pre>                      |
| 3 Press the [F3](PLANE OFFSET) key.                                                                                                                         | [F3]                 | <pre> PLANE NO01#: SD: m MEAS --- --- ---                     </pre>                                             |
| 4 Collimate prism P1, and press the [F1](MEAS) key.<br>N-time measuring will start.<br>After measuring, the display will show the second point measurement. | Collimate P1<br>[F1] | <pre> PLANE NO01#: SD* [n] &lt;&lt; m &gt;Measuring...                     </pre>                                |
| 5 Measure the second and third points in the same way.                                                                                                      | Collimate P2<br>[F1] | <pre> PLANE NO02#: SD: m MEAS --- --- ---                     </pre>                                             |



#### 4.7.4 Column Offset Measurement

If it is possible to measure circumscription point (P1) of column directly, the distance to the center of the column (P0), coordinate and direction angle can be calculated by measured circumscription points (P2) and (P3).

The direction angle of the center of the column is 1/2 of total direction angle of circumscription points (P2) and (P3).

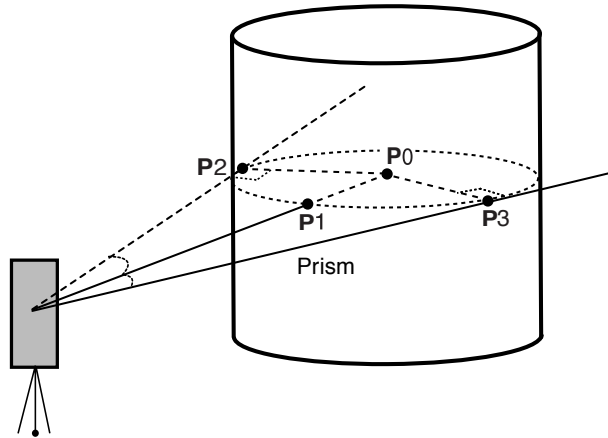

- When setting the coordinate value for the occupied station, refer to Section 5.1 "Setting Coordinate Values of Occupied Point".

| Operating procedure                                                                                            | Operation               | Display                                                                                                       |
|----------------------------------------------------------------------------------------------------------------|-------------------------|---------------------------------------------------------------------------------------------------------------|
| <b>1</b> Press the [F4](P1↓) key from distance measuring mode to get the function on page 2.                   | [F4]                    | <pre> HR:  120°30'40" HD:  123.456 m VD:  5.678 m MEAS MODE S/A P1↓ OFFSET S.O m/f/i P2↓ </pre>               |
| <b>2</b> Press the [F1](OFFSET) key.                                                                           | [F1]                    | <pre> OFFSET          1/2 F1:ANG.OFFSET F2:DIST.OFFSET F3:PLANE OFFSET P↓ </pre>                              |
| <b>3</b> Press the [F4](P↓) key.                                                                               | [F4]                    | <pre> OFFSET          2/2 F1:COLUMN OFFSET  P↓ </pre>                                                         |
| <b>4</b> Press the [F1](COLUMN OFFSET) key.                                                                    | [F1]                    | <pre> COLUMN OFFSET Center HD:          m MEAS  ---  ---  --- </pre>                                          |
| <b>5</b> Collimate the center of the column (P1) and press the [F1](MEAS) key.<br>N-time measuring will start. | Collimate<br>P1<br>[F1] | <pre> COLUMN OFFSET Center HD* [n]    &lt;&lt; m &gt;Measuring... </pre> <p style="text-align: center;">↓</p> |

After the measurement, angle measuring display of the left side (P2) will be shown.

- 6** Collimate the left side of the column (P2) and press the [F4](SET) key.  
After the measurement, angle measuring display of the right side (P3) will be shown.

- 7** Collimate the right side of the column (P3) and press the [F4](SET) key.

The distance between the instrument and center of the column (P0) will be calculated.

- 8** To show the relative elevation (VD), press the [  ] key.

Each time pressing the [  ] key, horizontal distance, relative elevation and slope distance are shown in sequence.

- To show coordinate of point P0, press the [  ] key.
- 9** To escape the measuring, press the [ESC] key.  
The display returns to the previous mode.

Collimate  
P2  
[F4]

Collimate  
P3  
[F4]

[  ]

|                        |
|------------------------|
| <b>COLUMN OFFSET</b>   |
| <b>Left</b>            |
| <b>HR: 120°30'40"</b>  |
| --- --- --- <b>SET</b> |



|                        |
|------------------------|
| <b>COLUMN OFFSET</b>   |
| <b>Right</b>           |
| <b>HR: 180°30'40"</b>  |
| --- --- --- <b>SET</b> |



|                         |
|-------------------------|
| <b>COLUMN OFFSET</b>    |
| <b>HR: 150°30'40"</b>   |
| <b>HD: 43.321 m</b>     |
| <b>NEXT</b> --- --- --- |

|                         |
|-------------------------|
| <b>COLUMN OFFSET</b>    |
| <b>HR: 150°30'40"</b>   |
| <b>VD: 2.321 m</b>      |
| <b>NEXT</b> --- --- --- |

# 5 COORDINATE MEASUREMENT

## 5.1 Setting Coordinate Values of Occupied Point

Set the coordinates of the instrument (occupied point) according to coordinate origin, and the instrument automatically converts and displays the unknown point (prism point) coordinates following the origin.

It is possible to retain the coordinates of the occupied point after turning the power off. Refer to Chapter 16 "SELECTING MODE".

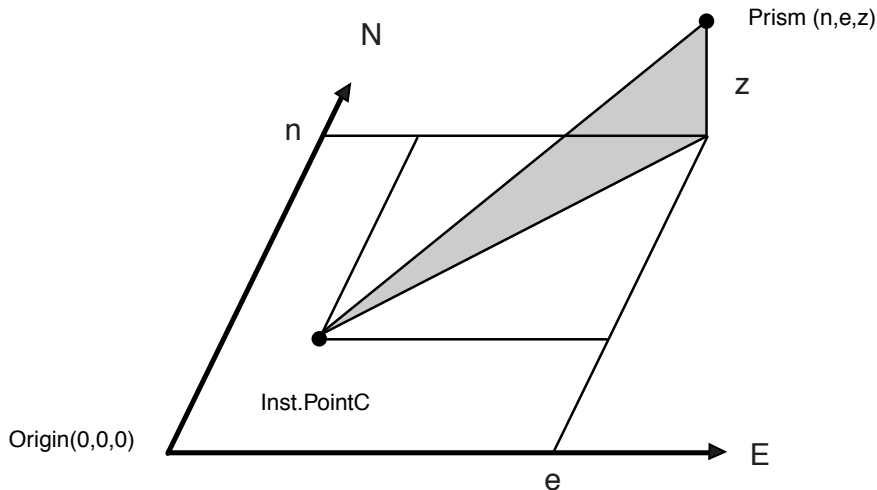

| Operating procedure                                                                                                                                                                                                                              | Operation                  | Display                                                                                                                                                                                                                                                                      |           |           |           |          |           |          |                         |              |                          |                   |
|--------------------------------------------------------------------------------------------------------------------------------------------------------------------------------------------------------------------------------------------------|----------------------------|------------------------------------------------------------------------------------------------------------------------------------------------------------------------------------------------------------------------------------------------------------------------------|-----------|-----------|-----------|----------|-----------|----------|-------------------------|--------------|--------------------------|-------------------|
| <b>1</b> Press the [F4](↓) key from the coordinate measurement mode to get the function on page 2.                                                                                                                                               | [F4]                       | <table border="1"> <tr><td><b>N:</b></td><td>123.456 m</td></tr> <tr><td><b>E:</b></td><td>34.567 m</td></tr> <tr><td><b>Z:</b></td><td>78.912 m</td></tr> <tr><td><b>MEAS MODE S/A P1</b></td><td>↓</td></tr> <tr><td><b>R.HT INSHT OCC P2</b></td><td>↓</td></tr> </table> | <b>N:</b> | 123.456 m | <b>E:</b> | 34.567 m | <b>Z:</b> | 78.912 m | <b>MEAS MODE S/A P1</b> | ↓            | <b>R.HT INSHT OCC P2</b> | ↓                 |
| <b>N:</b>                                                                                                                                                                                                                                        | 123.456 m                  |                                                                                                                                                                                                                                                                              |           |           |           |          |           |          |                         |              |                          |                   |
| <b>E:</b>                                                                                                                                                                                                                                        | 34.567 m                   |                                                                                                                                                                                                                                                                              |           |           |           |          |           |          |                         |              |                          |                   |
| <b>Z:</b>                                                                                                                                                                                                                                        | 78.912 m                   |                                                                                                                                                                                                                                                                              |           |           |           |          |           |          |                         |              |                          |                   |
| <b>MEAS MODE S/A P1</b>                                                                                                                                                                                                                          | ↓                          |                                                                                                                                                                                                                                                                              |           |           |           |          |           |          |                         |              |                          |                   |
| <b>R.HT INSHT OCC P2</b>                                                                                                                                                                                                                         | ↓                          |                                                                                                                                                                                                                                                                              |           |           |           |          |           |          |                         |              |                          |                   |
| <b>2</b> Press the [F3](OCC) key.                                                                                                                                                                                                                | [F3]                       | <table border="1"> <tr><td><b>N→</b></td><td>0.000 m</td></tr> <tr><td><b>E:</b></td><td>0.000 m</td></tr> <tr><td><b>Z:</b></td><td>0.000 m</td></tr> <tr><td><b>INPUT ---</b></td><td><b>ENTER</b></td></tr> <tr><td>[---]</td><td>[---] [CLR] [ENT]</td></tr> </table>    | <b>N→</b> | 0.000 m   | <b>E:</b> | 0.000 m  | <b>Z:</b> | 0.000 m  | <b>INPUT ---</b>        | <b>ENTER</b> | [---]                    | [---] [CLR] [ENT] |
| <b>N→</b>                                                                                                                                                                                                                                        | 0.000 m                    |                                                                                                                                                                                                                                                                              |           |           |           |          |           |          |                         |              |                          |                   |
| <b>E:</b>                                                                                                                                                                                                                                        | 0.000 m                    |                                                                                                                                                                                                                                                                              |           |           |           |          |           |          |                         |              |                          |                   |
| <b>Z:</b>                                                                                                                                                                                                                                        | 0.000 m                    |                                                                                                                                                                                                                                                                              |           |           |           |          |           |          |                         |              |                          |                   |
| <b>INPUT ---</b>                                                                                                                                                                                                                                 | <b>ENTER</b>               |                                                                                                                                                                                                                                                                              |           |           |           |          |           |          |                         |              |                          |                   |
| [---]                                                                                                                                                                                                                                            | [---] [CLR] [ENT]          |                                                                                                                                                                                                                                                                              |           |           |           |          |           |          |                         |              |                          |                   |
| <b>3</b> Enter N coordinate value. *1)                                                                                                                                                                                                           | [F1]<br>Enter data<br>[F4] | <table border="1"> <tr><td><b>N:</b></td><td>-72.000 m</td></tr> <tr><td><b>E→</b></td><td>0.000 m</td></tr> <tr><td><b>Z:</b></td><td>0.000 m</td></tr> <tr><td><b>INPUT ---</b></td><td><b>ENTER</b></td></tr> </table>                                                    | <b>N:</b> | -72.000 m | <b>E→</b> | 0.000 m  | <b>Z:</b> | 0.000 m  | <b>INPUT ---</b>        | <b>ENTER</b> |                          |                   |
| <b>N:</b>                                                                                                                                                                                                                                        | -72.000 m                  |                                                                                                                                                                                                                                                                              |           |           |           |          |           |          |                         |              |                          |                   |
| <b>E→</b>                                                                                                                                                                                                                                        | 0.000 m                    |                                                                                                                                                                                                                                                                              |           |           |           |          |           |          |                         |              |                          |                   |
| <b>Z:</b>                                                                                                                                                                                                                                        | 0.000 m                    |                                                                                                                                                                                                                                                                              |           |           |           |          |           |          |                         |              |                          |                   |
| <b>INPUT ---</b>                                                                                                                                                                                                                                 | <b>ENTER</b>               |                                                                                                                                                                                                                                                                              |           |           |           |          |           |          |                         |              |                          |                   |
| <b>4</b> Enter E and Z coordinate values in the same manner.<br><br>After entering the values, the display returns coordinate measuring display.                                                                                                 |                            | <table border="1"> <tr><td><b>N:</b></td><td>51.456 m</td></tr> <tr><td><b>E:</b></td><td>34.567 m</td></tr> <tr><td><b>Z:</b></td><td>78.912 m</td></tr> <tr><td><b>MEAS MODE S/A P1</b></td><td>↓</td></tr> </table>                                                       | <b>N:</b> | 51.456 m  | <b>E:</b> | 34.567 m | <b>Z:</b> | 78.912 m | <b>MEAS MODE S/A P1</b> | ↓            |                          |                   |
| <b>N:</b>                                                                                                                                                                                                                                        | 51.456 m                   |                                                                                                                                                                                                                                                                              |           |           |           |          |           |          |                         |              |                          |                   |
| <b>E:</b>                                                                                                                                                                                                                                        | 34.567 m                   |                                                                                                                                                                                                                                                                              |           |           |           |          |           |          |                         |              |                          |                   |
| <b>Z:</b>                                                                                                                                                                                                                                        | 78.912 m                   |                                                                                                                                                                                                                                                                              |           |           |           |          |           |          |                         |              |                          |                   |
| <b>MEAS MODE S/A P1</b>                                                                                                                                                                                                                          | ↓                          |                                                                                                                                                                                                                                                                              |           |           |           |          |           |          |                         |              |                          |                   |
| *1) Refer to Section 2.6 "How to Enter Alphanumeric characters".<br>● Input range $-9999999.9990 \leq N,E,Z \leq +99999999.9990m$<br>$-9999999.999 \leq N,E,Z \leq +99999999.999 ft.$<br>$-9999999.11.7 \leq N,E,Z \leq +99999999.11.7 ft.+inch$ |                            |                                                                                                                                                                                                                                                                              |           |           |           |          |           |          |                         |              |                          |                   |

## 5.2 Setting Height of the Instrument

It is possible to retain the height of instrument after turning the power off. Refer to Chapter 16 "SELECTING MODE".

| Operating procedure                                                                                                                                                                                                                                              | Operation                     | Display                                                                                                                                                                                                                                 |                         |           |         |          |       |           |       |                   |      |               |
|------------------------------------------------------------------------------------------------------------------------------------------------------------------------------------------------------------------------------------------------------------------|-------------------------------|-----------------------------------------------------------------------------------------------------------------------------------------------------------------------------------------------------------------------------------------|-------------------------|-----------|---------|----------|-------|-----------|-------|-------------------|------|---------------|
| 1 Press the [F4](↓) key from the coordinate measurement mode to get the function on page 2.                                                                                                                                                                      | [F4]                          | <table border="1"> <tr><td>N:</td><td>123.456 m</td></tr> <tr><td>E:</td><td>34.567 m</td></tr> <tr><td>Z:</td><td>78.912 m</td></tr> <tr><td>MEAS</td><td>MODE S/A P1↓</td></tr> <tr><td>R.HT</td><td>INSHT OCC P2↓</td></tr> </table> | N:                      | 123.456 m | E:      | 34.567 m | Z:    | 78.912 m  | MEAS  | MODE S/A P1↓      | R.HT | INSHT OCC P2↓ |
| N:                                                                                                                                                                                                                                                               | 123.456 m                     |                                                                                                                                                                                                                                         |                         |           |         |          |       |           |       |                   |      |               |
| E:                                                                                                                                                                                                                                                               | 34.567 m                      |                                                                                                                                                                                                                                         |                         |           |         |          |       |           |       |                   |      |               |
| Z:                                                                                                                                                                                                                                                               | 78.912 m                      |                                                                                                                                                                                                                                         |                         |           |         |          |       |           |       |                   |      |               |
| MEAS                                                                                                                                                                                                                                                             | MODE S/A P1↓                  |                                                                                                                                                                                                                                         |                         |           |         |          |       |           |       |                   |      |               |
| R.HT                                                                                                                                                                                                                                                             | INSHT OCC P2↓                 |                                                                                                                                                                                                                                         |                         |           |         |          |       |           |       |                   |      |               |
| 2 Press the [F2](INSHT) key.<br>The current value is displayed.                                                                                                                                                                                                  | [F2]                          | <table border="1"> <tr><td colspan="2">INSTRUMENT HEIGHT INPUT</td></tr> <tr><td>INS.HT:</td><td>0.000 m</td></tr> <tr><td>INPUT</td><td>— — ENTER</td></tr> <tr><td>[---]</td><td>[---] [CLR] [ENT]</td></tr> </table>                 | INSTRUMENT HEIGHT INPUT |           | INS.HT: | 0.000 m  | INPUT | — — ENTER | [---] | [---] [CLR] [ENT] |      |               |
| INSTRUMENT HEIGHT INPUT                                                                                                                                                                                                                                          |                               |                                                                                                                                                                                                                                         |                         |           |         |          |       |           |       |                   |      |               |
| INS.HT:                                                                                                                                                                                                                                                          | 0.000 m                       |                                                                                                                                                                                                                                         |                         |           |         |          |       |           |       |                   |      |               |
| INPUT                                                                                                                                                                                                                                                            | — — ENTER                     |                                                                                                                                                                                                                                         |                         |           |         |          |       |           |       |                   |      |               |
| [---]                                                                                                                                                                                                                                                            | [---] [CLR] [ENT]             |                                                                                                                                                                                                                                         |                         |           |         |          |       |           |       |                   |      |               |
| 3 Enter the instrument height. *1)                                                                                                                                                                                                                               | [F1]<br>Enter Inst.HT<br>[F4] | <table border="1"> <tr><td>N:</td><td>123.456 m</td></tr> <tr><td>E:</td><td>34.567 m</td></tr> <tr><td>Z:</td><td>78.912 m</td></tr> <tr><td>MEAS</td><td>MODE S/A P1↓</td></tr> </table>                                              | N:                      | 123.456 m | E:      | 34.567 m | Z:    | 78.912 m  | MEAS  | MODE S/A P1↓      |      |               |
| N:                                                                                                                                                                                                                                                               | 123.456 m                     |                                                                                                                                                                                                                                         |                         |           |         |          |       |           |       |                   |      |               |
| E:                                                                                                                                                                                                                                                               | 34.567 m                      |                                                                                                                                                                                                                                         |                         |           |         |          |       |           |       |                   |      |               |
| Z:                                                                                                                                                                                                                                                               | 78.912 m                      |                                                                                                                                                                                                                                         |                         |           |         |          |       |           |       |                   |      |               |
| MEAS                                                                                                                                                                                                                                                             | MODE S/A P1↓                  |                                                                                                                                                                                                                                         |                         |           |         |          |       |           |       |                   |      |               |
| *1) Refer to Section 2.6 "How to Enter Alphanumeric characters".<br>● Input range $-999.9999 \leq$ Instrument height $\leq +999.9999$ m<br>$-999.999 \leq$ Instrument height $\leq +999.999$ ft.<br>$-999.11.7 \leq$ Instrument height $\leq +999.11.7$ ft.+inch |                               |                                                                                                                                                                                                                                         |                         |           |         |          |       |           |       |                   |      |               |

## 5.3 Setting Height of Target (Prism Height)

This mode can be used to obtain Z coordinate values. It is possible to retain the height of target after turning the power off. Refer to Chapter 16 "SELECTING MODE".

| Operating procedure                                                                                                                                                                                                                               | Operation                  | Display                                                                                                                                                                                                                                 |                        |           |       |          |       |           |       |                   |      |               |
|---------------------------------------------------------------------------------------------------------------------------------------------------------------------------------------------------------------------------------------------------|----------------------------|-----------------------------------------------------------------------------------------------------------------------------------------------------------------------------------------------------------------------------------------|------------------------|-----------|-------|----------|-------|-----------|-------|-------------------|------|---------------|
| 1 Press the [F4](↓) key from the coordinate measurement mode to get the function on page 2.                                                                                                                                                       | [F4]                       | <table border="1"> <tr><td>N:</td><td>123.456 m</td></tr> <tr><td>E:</td><td>34.567 m</td></tr> <tr><td>Z:</td><td>78.912 m</td></tr> <tr><td>MEAS</td><td>MODE S/A P1↓</td></tr> <tr><td>R.HT</td><td>INSHT OCC P2↓</td></tr> </table> | N:                     | 123.456 m | E:    | 34.567 m | Z:    | 78.912 m  | MEAS  | MODE S/A P1↓      | R.HT | INSHT OCC P2↓ |
| N:                                                                                                                                                                                                                                                | 123.456 m                  |                                                                                                                                                                                                                                         |                        |           |       |          |       |           |       |                   |      |               |
| E:                                                                                                                                                                                                                                                | 34.567 m                   |                                                                                                                                                                                                                                         |                        |           |       |          |       |           |       |                   |      |               |
| Z:                                                                                                                                                                                                                                                | 78.912 m                   |                                                                                                                                                                                                                                         |                        |           |       |          |       |           |       |                   |      |               |
| MEAS                                                                                                                                                                                                                                              | MODE S/A P1↓               |                                                                                                                                                                                                                                         |                        |           |       |          |       |           |       |                   |      |               |
| R.HT                                                                                                                                                                                                                                              | INSHT OCC P2↓              |                                                                                                                                                                                                                                         |                        |           |       |          |       |           |       |                   |      |               |
| 2 Press the [F1](R.HT) key.<br>The current value is displayed.                                                                                                                                                                                    | [F1]                       | <table border="1"> <tr><td colspan="2">REFLECTOR HEIGHT INPUT</td></tr> <tr><td>R.HT:</td><td>0.000 m</td></tr> <tr><td>INPUT</td><td>— — ENTER</td></tr> <tr><td>[---]</td><td>[---] [CLR] [ENT]</td></tr> </table>                    | REFLECTOR HEIGHT INPUT |           | R.HT: | 0.000 m  | INPUT | — — ENTER | [---] | [---] [CLR] [ENT] |      |               |
| REFLECTOR HEIGHT INPUT                                                                                                                                                                                                                            |                            |                                                                                                                                                                                                                                         |                        |           |       |          |       |           |       |                   |      |               |
| R.HT:                                                                                                                                                                                                                                             | 0.000 m                    |                                                                                                                                                                                                                                         |                        |           |       |          |       |           |       |                   |      |               |
| INPUT                                                                                                                                                                                                                                             | — — ENTER                  |                                                                                                                                                                                                                                         |                        |           |       |          |       |           |       |                   |      |               |
| [---]                                                                                                                                                                                                                                             | [---] [CLR] [ENT]          |                                                                                                                                                                                                                                         |                        |           |       |          |       |           |       |                   |      |               |
| 3 Enter the prism height. *1)                                                                                                                                                                                                                     | [F1]<br>Enter R.HT<br>[F4] | <table border="1"> <tr><td>N:</td><td>123.456 m</td></tr> <tr><td>E:</td><td>34.567 m</td></tr> <tr><td>Z:</td><td>78.912 m</td></tr> <tr><td>MEAS</td><td>MODE S/A P1↓</td></tr> </table>                                              | N:                     | 123.456 m | E:    | 34.567 m | Z:    | 78.912 m  | MEAS  | MODE S/A P1↓      |      |               |
| N:                                                                                                                                                                                                                                                | 123.456 m                  |                                                                                                                                                                                                                                         |                        |           |       |          |       |           |       |                   |      |               |
| E:                                                                                                                                                                                                                                                | 34.567 m                   |                                                                                                                                                                                                                                         |                        |           |       |          |       |           |       |                   |      |               |
| Z:                                                                                                                                                                                                                                                | 78.912 m                   |                                                                                                                                                                                                                                         |                        |           |       |          |       |           |       |                   |      |               |
| MEAS                                                                                                                                                                                                                                              | MODE S/A P1↓               |                                                                                                                                                                                                                                         |                        |           |       |          |       |           |       |                   |      |               |
| *1) Refer to Section 2.6 "How to Enter Alphanumeric characters".<br>● Input range $-999.9999 \leq$ Prism height $\leq +999.9999$ m<br>$-999.999 \leq$ Prism height $\leq +999.999$ ft.<br>$-999.11.7 \leq$ Prism height $\leq +999.11.7$ ft.+inch |                            |                                                                                                                                                                                                                                         |                        |           |       |          |       |           |       |                   |      |               |

### 5.4 Execution of Coordinate Measuring

Measure the coordinates by entering the instrument height and prism height, coordinates of unknown point will be measured directly.

- When setting coordinate values of occupied point, see Section 5.1 “Setting Coordinate Values of Occupied Point”
- When setting the instrument height and prism height, see Section 5.2 “Setting Height of the Instrument” and 5.3 “Setting Height of Target (Prism Height)”.
- The coordinates of the unknown point are calculated as shown below and displayed:

Coordinates of occupied point :  $(N_0, E_0, Z_0)$   
 Instrument height : INS.HT  
 Prism height : R.HT  
 Vertical distance (Relative elevation) :  $z$  (VD)  
 Coordinates of the center of the prism, originated from the center point of the instrument :  $(n, e, z)$   
 Coordinates of unknown point :  $(N_1, E_1, Z_1)$

$$N_1 = N_0 + n$$

$$E_1 = E_0 + e$$

$$Z_1 = Z_0 + \text{INS.HT} + z - \text{R.HT}$$

Coordinates of the center of the prism, originated from the center point of the instrument  $(n, e, z)$

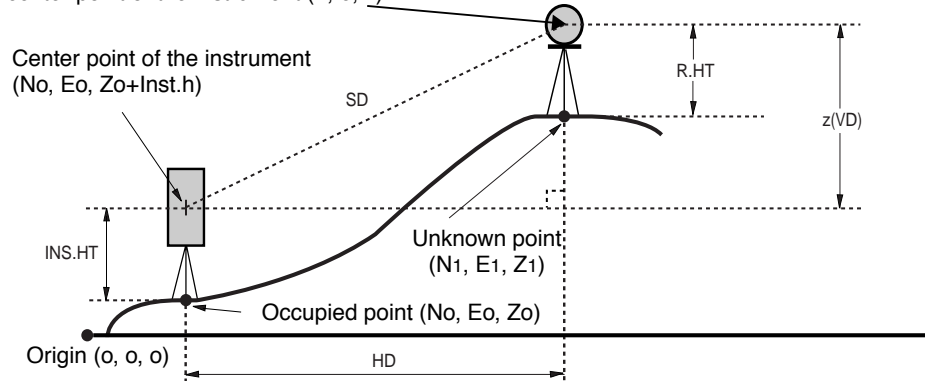

| Operating procedure                             | Operation           | Display                                                         |
|-------------------------------------------------|---------------------|-----------------------------------------------------------------|
| 1 Set the direction angle of known point A. *1) | Set direction angle | V : 90°10'20"<br>HR: 120°30'40"                                 |
| 2 Collimate target prism.                       | Collimate P         | OSET HOLD HSET P1↓                                              |
| 3 Press the [↖] key.<br>Measuring starts.       | [↖]                 | N* [r] << m<br>E: m<br>Z: m<br>MEAS MODE S/A P1↓                |
| The result will be shown.                       |                     | N* 123.456 m<br>E: 34.567 m<br>Z: 78.912 m<br>MEAS MODE S/A P1↓ |

\*1) Refer to Section 3.3 “Measuring from the Required Horizontal Angle”.

- In case the coordinate of instrument point is not entered, (0,0,0) will be used as the default for the instrument point.
- The instrument height will be calculated as 0 when the instrument height is not entered.
- The prism height will be calculated as 0 when the prism height is not set.

# 6 SPECIAL MODE (Menu Mode)

By pressing the [MENU] key, the instrument will be in MENU mode.  
 In this mode, special measuring, setting and adjustment are possible.

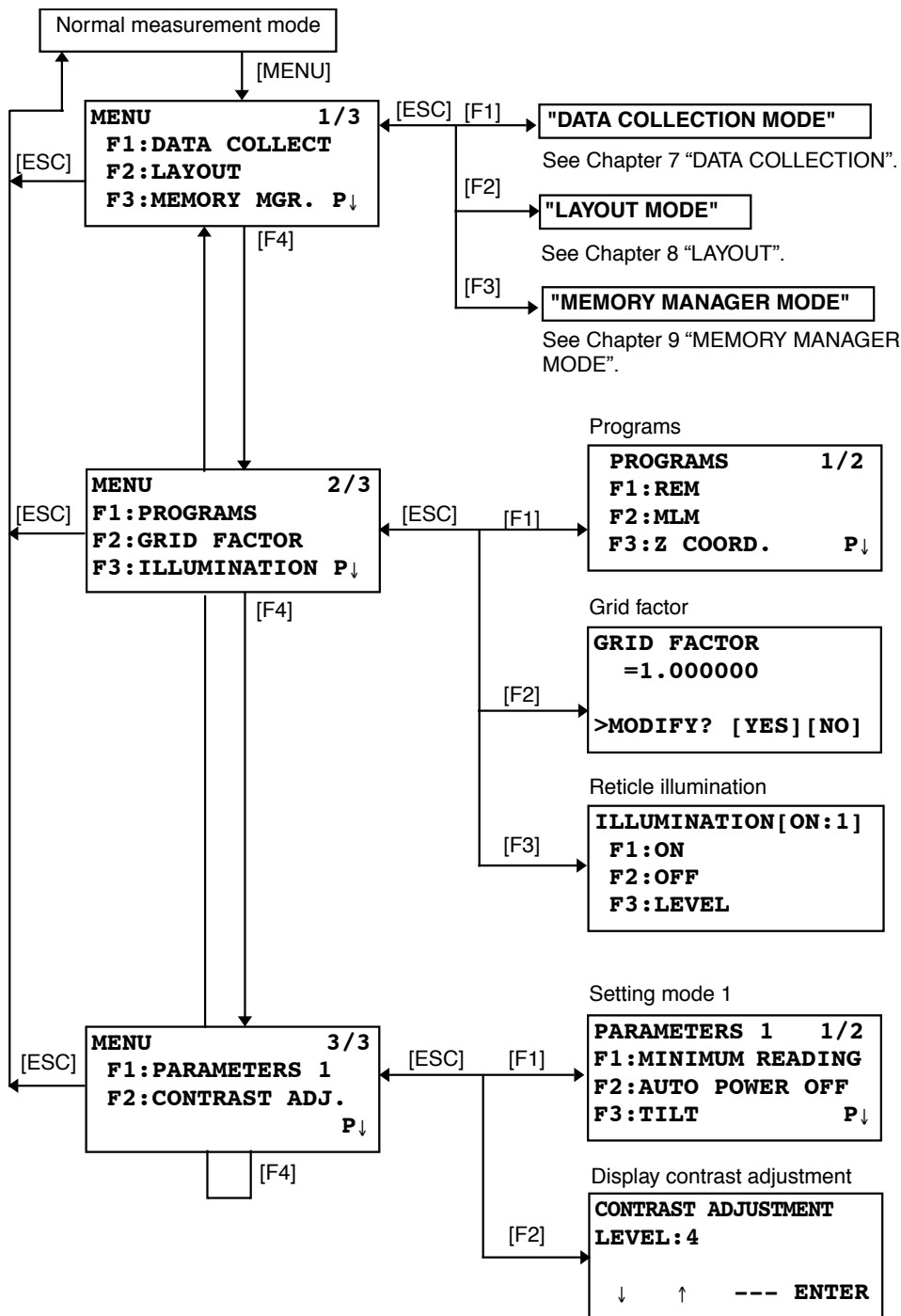



## 6.1 Application Measurement (PROGRAMS)

### 6.1.1 Remote Elevation measurement (REM)

To obtain elevation of the point at which setting the target prism is not possible, place the prism at any point on the vertical line from the target then carry out REM procedure as follows.

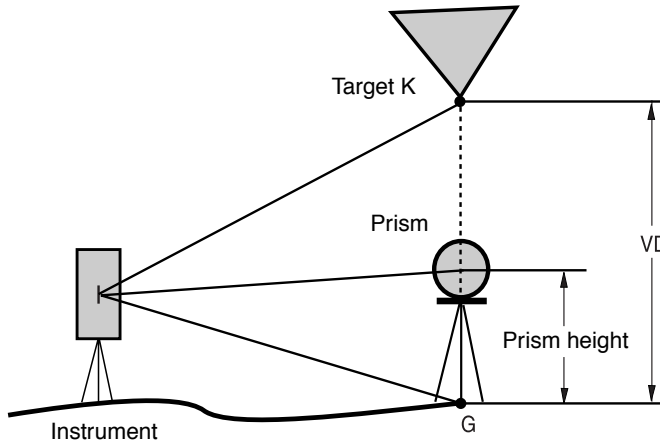

1) With prism height (h) input (Example :h=1.5m)

| Operating procedure                                                                       | Operation                  | Display                                                                                                                            |
|-------------------------------------------------------------------------------------------|----------------------------|------------------------------------------------------------------------------------------------------------------------------------|
| <b>1</b> After pressing the [MENU] key, press the [F4](P↓) key to get the menu on page 2. | [MENU]<br>[F4]             | <b>MENU</b> 2/3<br><b>F1: PROGRAMS</b><br><b>F2: GRID FACTOR</b><br><b>F3: ILLUMINATION P↓</b>                                     |
| <b>2</b> Press the [F1] key.                                                              | [F1]                       | <b>PROGRAMS</b> 1/2<br><b>F1: REM</b><br><b>F2: MLM</b><br><b>F3: Z COORD. P↓</b>                                                  |
| <b>3</b> Press the [F1](REM) key.                                                         | [F1]                       | <b>REM</b><br><b>F1: INPUT R.HT</b><br><b>F2: NO R.HT</b>                                                                          |
| <b>4</b> Press the [F1] key.                                                              | [F1]                       | <b>REM-1</b><br><b>&lt;STEP-1&gt;</b><br><b>R.HT : 0.000 m</b><br><b>INPUT — — ENTER</b><br><b>[ --- ] [ --- ] [ CLR ] [ ENT ]</b> |
| <b>5</b> Enter prism height. *1)                                                          | [F1]<br>Enter R.HT<br>[F4] | <b>REM-1</b><br><b>&lt;STEP-2&gt;</b><br><b>HD: — — m</b><br><b>MEAS — — SET</b>                                                   |
| <b>6</b> Collimate prism.                                                                 | Collimate P                |                                                                                                                                    |
| <b>7</b> Press the [F1](MEAS) key.<br>Measuring starts.                                   | [F1]                       | <b>REM-1</b><br><b>&lt;STEP-2&gt;</b><br><b>HD* [n] &lt;&lt; m</b><br><b>&gt;Measuring...</b>                                      |



|                                                                                                                                                                                                                                                                        |             |                                                                                                                                                                                                                                                                                                                                                                                                                                                                   |
|------------------------------------------------------------------------------------------------------------------------------------------------------------------------------------------------------------------------------------------------------------------------|-------------|-------------------------------------------------------------------------------------------------------------------------------------------------------------------------------------------------------------------------------------------------------------------------------------------------------------------------------------------------------------------------------------------------------------------------------------------------------------------|
| <p>Horizontal distance (HD) between the instrument and prism will be shown.</p> <p><b>8</b> After measuring, the prism position will be decided. *2)</p> <p><b>9</b> Collimate target K.<br/>Vertical distance (VD) will be shown. *3)</p>                             | Collimate K | <div style="border: 1px solid black; padding: 5px; margin-bottom: 5px;"> <b>REM-1</b><br/> <b>&lt;STEP-2&gt;</b><br/> <b>HD* 123.456 m</b><br/> <b>&gt;Measuring...</b> </div> <div style="border: 1px solid black; padding: 5px; margin-bottom: 5px;"> <b>REM-1</b><br/> <b>VD: 1.500 m</b><br/> <br/> <b>— R.HT HD —</b> </div> <div style="border: 1px solid black; padding: 5px;"> <b>REM-1</b><br/> <b>VD: 10.456 m</b><br/> <br/> <b>— R.HT HD —</b> </div> |
| <p>*1) Refer to Section 2.6 “How to Enter Alphanumeric characters”.</p> <p>*2) To return to procedure <b>5</b>, press the [F2](R.HT) key.<br/>To return to procedure <b>6</b>, press the [F3](HD) key.</p> <p>*3) To return to PROGRAMS Menu, press the [ESC] key.</p> |             |                                                                                                                                                                                                                                                                                                                                                                                                                                                                   |

2) Without prism height input

| Operating procedure                                                                       | Operation      | Display                                                                                                                                                                                                                                                                                                                                                                                                           |
|-------------------------------------------------------------------------------------------|----------------|-------------------------------------------------------------------------------------------------------------------------------------------------------------------------------------------------------------------------------------------------------------------------------------------------------------------------------------------------------------------------------------------------------------------|
| <b>1</b> After pressing the [MENU] key, press the [F4](P↓) key to get the menu on page 2. | [MENU]<br>[F4] | <div style="border: 1px solid black; padding: 5px;"> <b>MENU</b> <span style="float: right;">2 / 3</span><br/> <b>F1: PROGRAMS</b><br/> <b>F2: GRID FACTOR</b><br/> <b>F3: ILLUMINATION P↓</b> </div>                                                                                                                                                                                                             |
| <b>2</b> Press the [F1] key.                                                              | [F1]           | <div style="border: 1px solid black; padding: 5px;"> <b>PROGRAMS</b> <span style="float: right;">1 / 2</span><br/> <b>F1: REM</b><br/> <b>F2: MLM</b><br/> <b>F3: Z COORD. P↓</b> </div>                                                                                                                                                                                                                          |
| <b>3</b> Press the [F1](REM) key.                                                         | [F1]           | <div style="border: 1px solid black; padding: 5px;"> <b>REM</b><br/> <b>F1: INPUT R.HT</b><br/> <b>F2: NO R.HT</b> </div>                                                                                                                                                                                                                                                                                         |
| <b>4</b> Press the [F2] key.                                                              | [F2]           | <div style="border: 1px solid black; padding: 5px;"> <b>REM-2</b><br/> <b>&lt;STEP-1&gt;</b><br/> <b>HD:            m</b><br/> <b>MEAS — — —</b> </div>                                                                                                                                                                                                                                                           |
| <b>5</b> Collimate prism.                                                                 | Collimate P    |                                                                                                                                                                                                                                                                                                                                                                                                                   |
| <b>6</b> Press the [F1](MEAS) key.<br>Measuring starts.                                   | [F1]           | <div style="border: 1px solid black; padding: 5px; margin-bottom: 5px;"> <b>REM-2</b><br/> <b>&lt;STEP-1&gt;</b><br/> <b>HD* [n]       &lt;&lt; m</b><br/> <b>&gt;Measuring...</b> </div> <div style="text-align: center; margin-bottom: 5px;">↓</div> <div style="border: 1px solid black; padding: 5px;"> <b>REM-2</b><br/> <b>&lt;STEP-1&gt;</b><br/> <b>HD* 123.456 m</b><br/> <b>&gt;Measuring...</b> </div> |
| Horizontal distance (HD) between the instrument and prism will be shown.                  |                |                                                                                                                                                                                                                                                                                                                                                                                                                   |

|                                                                                                                                                                                          |             |                                                                                  |
|------------------------------------------------------------------------------------------------------------------------------------------------------------------------------------------|-------------|----------------------------------------------------------------------------------|
| <p><b>7</b> After measuring, the prism position will be decided.</p>                                                                                                                     |             | <pre> <b>REM-2</b> &lt;<b>STEP-2</b>&gt; <b>V : 60°45'50"</b> <b>SET</b> </pre>  |
| <p><b>8</b> Collimate ground point G.</p>                                                                                                                                                | Collimate G | <pre> <b>REM-2</b> &lt;<b>STEP-2</b>&gt; <b>V : 123°45'50"</b> <b>SET</b> </pre> |
| <p><b>9</b> Press the [F4](SET) key.<br/>The position of point G will be decided. *1)</p>                                                                                                | [F4]        | <pre> <b>REM-2</b> <b>VD: 0.000 m</b> <b>— V HD —</b> </pre>                     |
| <p><b>10</b> Collimate target K.<br/>Vertical distance (VD) will be shown. *2)</p>                                                                                                       | Collimate K | <pre> <b>REM-2</b> <b>VD: 10.456 m</b> <b>— V HD —</b> </pre>                    |
| <p>*1) To return to procedure <b>5</b>, press the [F3](HD) key.<br/>To return to procedure <b>8</b>, press the [F2](V) key.<br/>*2) To return to PROGRAMS Menu, press the [ESC] key.</p> |             |                                                                                  |

### 6.1.2 Missing Line Measurement (MLM)

Measurement for horizontal distance (dHD), slope distance (dSD), elevation (dVD) and horizontal bearing (HR) between two target prisms.

It is possible to enter the coordinate value directly or calculate from coordinate data file.

MLM mode has two modes.

1. MLM-1 (A-B, A-C) : Measurement is A-B, A-C, A-D,.....

2. MLM-2 (A-B, B-C) : Measurement is A-B, B-C, C-D,.....

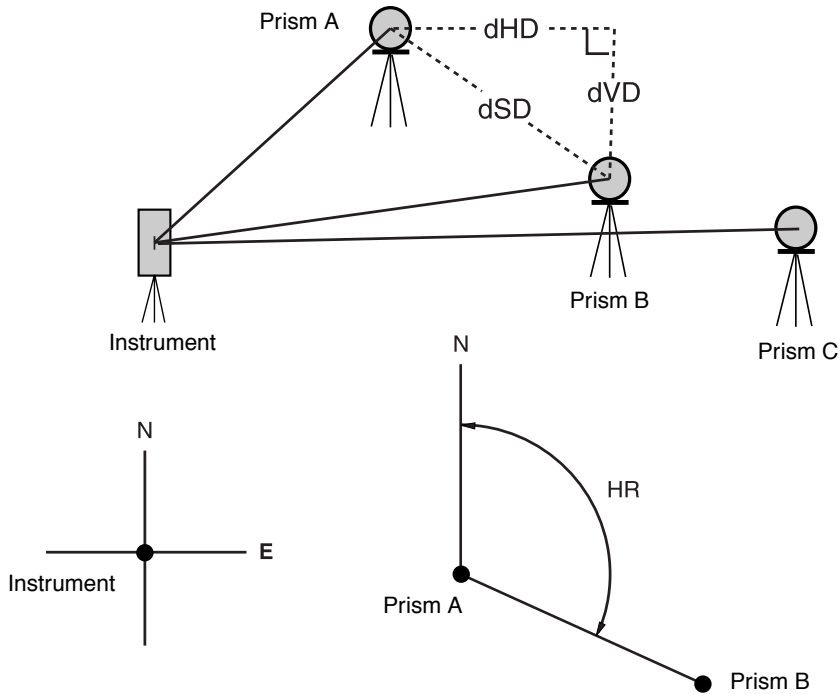



- It is necessary to set the direction angle of the instrument.

[Example] MLM-1 (A-B, A-C)

- Procedure of MLM-2 (A-B, B-C) mode is completely same as MLM-1 mode

| Operating procedure                                                                               | Operation      | Display                                                                                             |
|---------------------------------------------------------------------------------------------------|----------------|-----------------------------------------------------------------------------------------------------|
| <b>1</b> After pressing the [MENU] key, press the [F4](P↓) key to get the menu on page 2.         | [MENU]<br>[F4] | <b>MENU</b> 2 / 3<br><b>F1 : PROGRAMS</b><br><b>F2 : GRID FACTOR</b><br><b>F3 : ILLUMINATION P↓</b> |
| <b>2</b> Press the [F1] key.                                                                      | [F1]           | <b>PROGRAMS</b> 1 / 2<br><b>F1 : REM</b><br><b>F2 : MLM</b><br><b>F3 : Z COORD. P↓</b>              |
| <b>3</b> Press the [F2](MLM) key.                                                                 | [F2]           | <b>MLM</b><br><b>F1 : USE FILE</b><br><b>F2 : DON'T USE</b>                                         |
| <b>4</b> Press the [F1] or [F2] key to select using coordinate file.<br>[Example: F2 : DON'T USE] | [F2]           | <b>GRID FACTOR</b><br><b>F1 : USE G.F.</b><br><b>F2 : DON'T USE</b>                                 |

|                                                                                                                                                       |                                                                                         |                                                                                                                   |
|-------------------------------------------------------------------------------------------------------------------------------------------------------|-----------------------------------------------------------------------------------------|-------------------------------------------------------------------------------------------------------------------|
| <p><b>5</b> Press the [F1] or [F2] key to select using GRID FACTOR.<br/>[Example:F2 : DON'T USE]</p>                                                  | [F2]                                                                                    | <pre>MLM F1:MLM-1(A-B, A-C) F2:MLM-2(A-B, B-C)</pre>                                                              |
| <p><b>6</b> Press the [F1] key.</p>                                                                                                                   | [F1]                                                                                    | <pre>MLM-1(A-B, A-C) &lt;STEP-1&gt; HD:           m MEAS  R.HT  NEZ  —</pre>                                      |
| <p><b>7</b> Collimate prism A, and press the [F1](MEAS) key. Horizontal distance (HD) between the instrument and prism A will be shown.</p>           | Collimate A<br>[F1]                                                                     | <pre>MLM-1(A-B, A-C) &lt;STEP-1&gt; HD* [n]           &lt;&lt; m &gt;Measuring...</pre>                           |
| <p><b>8</b> After measuring, the prism position will be decided.</p>                                                                                  |                                                                                         | <p style="text-align: center;">↓</p> <pre>MLM-1(A-B, A-C) &lt;STEP-2&gt; HD:           m MEAS  R.HT  NEZ  —</pre> |
| <p><b>9</b> Collimate prism B and press the [F1](MEAS) key. Horizontal distance (HD) between the instrument and prism B will be shown.</p>            | Collimate B<br>[F1]                                                                     | <pre>MLM-1(A-B, A-C) &lt;STEP-2&gt; HD* [n]           &lt;&lt; m MEAS  R.HT  NEZ  —</pre>                         |
| <p><b>10</b> After measuring, the horizontal distance (dHD) and relative elevation (dVD) between prism A and B will be shown.</p>                     | [F4]                                                                                    | <p style="text-align: center;">↓</p> <pre>MLM-1(A-B, A-C) dHD : 123.456 m dVD : 12.345 m — — — HD —</pre>         |
| <p><b>11</b> To show slope distance (dSD) , press [  ] key.</p>    | [  ] | <pre>MLM-1(A-B, A-C) dSD : 234.567 m HR : 12°34'40" — — — HD —</pre>                                              |
| <p><b>12</b> To measure the distance between points A and C, press the [F3](HD). *1)</p>                                                              | [F3]                                                                                    | <pre>MLM-1(A-B, A-C) &lt;STEP-2&gt; HD:           m MEAS  R.HT  NEZ  —</pre>                                      |
| <p><b>13</b> Collimate point C (Prism C) and press the [F1](MEAS) key. Horizontal distance (HD) between the instrument and prism C will be shown.</p> | Collimate prism C<br>[F1]                                                               | <p style="text-align: center;">⋮</p>                                                                              |
| <p><b>14</b> After measuring, the horizontal distance (dHD) and relative elevation (dVD) between prism A and C will be shown.</p>                     | [F4]                                                                                    | <pre>MLM-1(A-B, A-C) dHD : 234.567 m dVD : 23.456 m — — — HD —</pre>                                              |
| <p><b>15</b> To measure the distance between points A and D, repeat procedure 12 to14. *1)</p>                                                        |                                                                                         |                                                                                                                   |

\*1) To return to previous mode, press the [ESC] key.



### 6.1.3 Setting Z Coordinate of Occupied Point

Occupied point coordinate data and known point actual measuring data are utilized, z coordinate of occupied point is calculated and reset again.

Known point data and coordinate data can use the coordinate data file.

#### 1) Setting occupied coordinate

[Example setting] Using coordinate data file.

| Operating procedure                                                                                             | Operation                 | Display                                                                                       |
|-----------------------------------------------------------------------------------------------------------------|---------------------------|-----------------------------------------------------------------------------------------------|
| <b>1</b> After pressing [MENU] key, press [F4](P↓) key to get the menu on page 2.                               | [MENU]<br>[F4]            | <b>MENU</b> 2 / 3<br><b>F1:PROGRAMS</b><br><b>F2:GRID FACTOR</b><br><b>F3:ILLUMINATION P↓</b> |
| <b>2</b> Press the [F1] key.                                                                                    | [F1]                      | <b>PROGRAMS</b> 1 / 2<br><b>F1:REM</b><br><b>F2:MLM</b><br><b>F3:Z COORD. P↓</b>              |
| <b>3</b> Press the [F3](Z COORD.) key.                                                                          | [F3]                      | <b>Z COORD.SETTING</b><br><b>F1:USE FILE</b><br><b>F2:DON'T USE</b>                           |
| <b>4</b> Press the [F1](USE FILE) key.                                                                          | [F1]                      | <b>SELECT A FILE</b><br><b>FN: _____</b><br><b>INPUT LIST — ENTER</b>                         |
| <b>5</b> Press the [F1](INPUT) key and enter the File Name.                                                     | [F1]<br>Enter FN<br>[F4]  | <b>Z COORD.SETTING</b><br><b>F1:OCC.PT INPUT</b><br><b>F2:REF.MEAS</b>                        |
| <b>6</b> Press the [F1] key.                                                                                    | [F1]                      | <b>OCC.PT</b><br><b>PT#: _____</b><br><b>INPUT LIST NEZ ENTER</b>                             |
| <b>7</b> Press the [F1](INPUT) key and enter the Point number. Instrument height setting display will be shown. | [F1]<br>Enter PT#<br>[F4] | <b>INSTRUMENT HEIGHT</b><br><b>INPUT</b><br><b>INS.HT: 0.000 m</b><br><b>INPUT — — ENTER</b>  |
| <b>8</b> Press the [F1](INPUT) key and enter the height.<br><br>The display returns to Z coordinate menu.       | [F1]<br>Enter HT<br>[F4]  | <b>Z COORD.SETTING</b><br><b>F1:OCC.PT INPUT</b><br><b>F2:REF.MEAS</b>                        |
| ● For more information about data file, see Chapter 9 "MEMORY MANAGER MODE".                                    |                           |                                                                                               |

## 2) Z Coordinate Calculation from Known Point Measuring Data

[Example setting] Using coordinate data file

| Operating procedure                                                                     | Operation                   | Display                                                            |
|-----------------------------------------------------------------------------------------|-----------------------------|--------------------------------------------------------------------|
| 1 After pressing [MENU] key, press [F4](P↓) key to get the menu on page 2.              | [MENU]<br>[F4]              | MENU 2/3<br>F1: PROGRAMS<br>F2: GRID FACTOR<br>F3: ILLUMINATION P↓ |
| 2 Press the [F1] key.                                                                   | [F1]                        | PROGRAMS 1/2<br>F1: REM<br>F2: MLM<br>F3: Z COORD. P↓              |
| 3 Press the [F3](Z COORD.) key.                                                         | [F3]                        | Z COORD. SETTING<br>F1: USE FILE<br>F2: DON'T USE                  |
| 4 Press the [F1](USE FILE) key.                                                         | [F1]                        | SELECT A FILE<br>FN: _____<br><br>INPUT LIST — ENTER               |
| 5 Press the [F1](INPUT) key and enter the File Name.                                    | [F1]<br>Enter FN<br>[F4]    | Z COORD. SETTING<br>F1: OCC. PT INPUT<br>F2: REF. MEAS             |
| 6 Press the [F2] key.                                                                   | [F2]                        | NOO1#<br>PT#: _____<br><br>INPUT LIST NEZ ENTER                    |
| 7 Press the [F1](INPUT) key and enter the Point Number in coordinate data file.         | [F1]<br>Enter PT#<br>[F4]   | N: 4.356 m<br>E: 16.283 m<br>Z: 1.553 m<br>>OK ? [YES] [NO]        |
| 8 Press the [F3](YES) key and enter the Point Number in coordinate data file.           | [F3]                        | REFLECTOR HEIGHT<br>INPUT<br>R.HT: 0.000 m<br>INPUT — — ENTER      |
| 9 Press the [F1](INPUT) key and enter the height.                                       | [F1]<br>Enter R. HT<br>[F4] | REFLECTOR HEIGHT<br>INPUT<br>R.HT: 0.000 m<br>>Sight? [YES] [NO]   |
| 10 Collimate a prism on the point and press the [F3](YES) key.<br>Measuring starts. *1) | Collimate P<br>[F3]         | HR: 120°30'40"<br>HD* [n] << m<br>VD: m<br>>Measuring...           |





**11** Press the [F4](CALC) key.\*2)

Z : Z coordinate

dZ: Standard deviation

[F4]

|             |                   |
|-------------|-------------------|
| <b>HR:</b>  | <b>120°30'40"</b> |
| <b>HD:</b>  | <b>12.345 m</b>   |
| <b>VD:</b>  | <b>23.456 m</b>   |
| <b>NEXT</b> | <b>— — CALC</b>   |

|                         |
|-------------------------|
| <b>Z COORD. SETTING</b> |
| <b>Z :</b> 1.234 m      |
| <b>dZ :</b> 0.002 m     |
| <b>— — BS SET</b>       |

**12** Press the [F4](SET) key. \*3)

Z coordinate of the occupied point will be set.

Bascksight point measuring screen will be shown.

[F4]

|                           |
|---------------------------|
| <b>BACKSIGHT</b>          |
| <b>HR:</b> 23°20'40"      |
| <b>&gt;OK?</b> [YES] [NO] |

**13** Press the [F3](YES) key.

Horizontal angle will be set.

The display returns to Programs 1/2 menu.

[F3]

|                    |            |
|--------------------|------------|
| <b>PROGRAMS</b>    | <b>1/2</b> |
| <b>F1:REM</b>      |            |
| <b>F2:MLM</b>      |            |
| <b>F3:Z COORD.</b> | <b>P↓</b>  |

\*1) Measurement is Fine N-times measurement mode.

\*2) To measure other points, press the [F1](NEXT) key.

\*3) Pressing the [F3] key, the display will be changed alternately.

### 6.1.4 Area Calculation

This mode calculate the area of a closed figure.

There are two area calculation methods as follows.

- 1) Area Calculation from Coordinate data file
- 2) Area Calculation from Measured data

- Area is not calculated correctly if enclosed lines cross each other.
- It is impossible to calculate what a mix of coordinate file data and measured data.
- If the coordinate data file does not exist, the area calculation from measured data is done automatically.
- The numbers of points used to calculate are not limited.

#### 1) Area Calculation from Coordinate Data File

| Operating procedure                                                                                                                    | Operation                | Display                                                                                        |
|----------------------------------------------------------------------------------------------------------------------------------------|--------------------------|------------------------------------------------------------------------------------------------|
| <b>1</b> After pressing the [MENU] key, press the [F4](P↓) key to get the menu on page 2/3.                                            | [MENU]<br>[F4]           | <b>MENU</b> 2/3<br><b>F1: PROGRAMS</b><br><b>F2: GRID FACTOR</b><br><b>F3: ILLUMINATION P↓</b> |
| <b>2</b> Press the [F1] key.                                                                                                           | [F1]                     | <b>PROGRAMS</b> 1/2<br><b>F1: REM</b><br><b>F2: MLM</b><br><b>F3: Z COORD. P↓</b>              |
| <b>3</b> Press the [F4](P↓) key to get the PROGRAMS menu on page 2/2.                                                                  | [F4]                     | <b>PROGRAMS</b> 2/2<br><b>F1: AREA</b><br><b>F2: POINT TO LINE</b><br><b>P↓</b>                |
| <b>4</b> Press the [F1](AREA) key.                                                                                                     | [F1]                     | <b>AREA</b><br><b>F1: FILE DATA</b><br><b>F2: MEASUREMENT</b>                                  |
| <b>5</b> Press the [F1](FILE DATA) key.                                                                                                | [F1]                     | <b>SELECT A FILE</b><br><b>FN: _____</b><br><b>INPUT LIST — ENTER</b>                          |
| <b>6</b> Press the [F1](INPUT) key and enter the File Name.<br>Initial display will be shown.                                          | [F1]<br>Enter FN<br>[F4] | <b>AREA</b> 0000<br><b>m.sq</b><br><b>NEXT# :DATA-01</b><br><b>PT# LIST UNIT NEXT</b>          |
| <b>7</b> Press the [F4](NEXT) key. *1),2)<br>The top of the file data (DATA-01) will be set and the second point number will be shown. | [F4]                     | <b>AREA</b> 0001<br><b>m.sq</b><br><b>NEXT# :DATA-02</b><br><b>PT# LIST UNIT NEXT</b>          |
| <b>8</b> Repeat pressing the [F4](NEXT) key to set required number of points.                                                          | [F4]                     | ⋮                                                                                              |

When 3 or more points are set, the area surrounded by the points is calculated and the result will be shown.

```

AREA          0021
              123.456 m.sq
NEXT# :DATA-22
PT# LIST UNIT NEXT
  
```

\*1) To set specify point, press the [F1](PT#) key.

\*2) To show the list of the coordinate data in the file, press the [F2](LIST) key.

## 2) Area Calculation from Measured Data

| Operating procedure                                                                          | Operation           | Display                                                                                                                                                                                                   |
|----------------------------------------------------------------------------------------------|---------------------|-----------------------------------------------------------------------------------------------------------------------------------------------------------------------------------------------------------|
| <b>1</b> After pressing the [MENU] key, press the [F4](P↓) key to get the menu on page 2/3.  | [MENU]<br>[F4]      | <pre> MENU          2 / 3 F1:PROGRAMS F2:GRID FACTOR F3:ILLUMINATION P↓           </pre>                                                                                                                  |
| <b>2</b> Press the [F1] key.                                                                 | [F1]                | <pre> PROGRAMS      1 / 2 F1:REM F2:MLM F3:Z COORD.   P↓           </pre>                                                                                                                                 |
| <b>3</b> Press the [F4](P↓) key to get the PROGRAMS menu on page 2/2.                        | [F4]                | <pre> PROGRAMS      2 / 2 F1:AREA F2:POINT TO LINE                 P↓           </pre>                                                                                                                    |
| <b>4</b> Press the [F1](AREA) key.                                                           | [F1]                | <pre> AREA F1:FILE DATA F2:MEASUREMENT           </pre>                                                                                                                                                   |
| <b>5</b> Press the [F2](MEASUREMENT) key.                                                    | [F2]                | <pre> AREA F1:USE G.F. F2:DON'T USE           </pre>                                                                                                                                                      |
| <b>6</b> Press the [F1] or [F2] key to select using GRID FACTOR.<br>[Example:F2 : DON'T USE] | [F2]                | <pre> AREA          0000               m.sq MEAS  ———  UNIT  ———           </pre>                                                                                                                         |
| <b>7</b> Collimate a prism and press the [F1](MEAS) key. Measuring starts. *1)               | Collimate P<br>[F1] | <pre> N* [n]  &lt;&lt;&lt; m E:      m Z:      m &gt;Measuring...           </pre> <p style="text-align: center;">↓</p> <pre> AREA          0001               m.sq MEAS  ———  UNIT  ———           </pre> |
| <b>8</b> Collimate next point and press the [F1](MEAS) key.                                  | Collimate<br>[F1]   | <p>⋮</p>                                                                                                                                                                                                  |

When 3 or more points are measured, the area surrounded by the points is calculated and the result will be shown.

|             |             |
|-------------|-------------|
| <b>AREA</b> | <b>0003</b> |
| 234.567     | m.sq        |
| <b>MEAS</b> | <b>UNIT</b> |

\*1) Measurement is Fine N-times measurement mode.

### ● To change the display unit

It is possible to change the displayed area unit.

| Operating procedure                                                                 | Operation   | Display                                                                                                                                                                         |             |             |         |      |                    |             |
|-------------------------------------------------------------------------------------|-------------|---------------------------------------------------------------------------------------------------------------------------------------------------------------------------------|-------------|-------------|---------|------|--------------------|-------------|
| 1 Press the [F3](UNIT) key.                                                         | [F3]        | <table border="1"> <tr> <td><b>AREA</b></td> <td><b>0003</b></td> </tr> <tr> <td>100.000</td> <td>m.sq</td> </tr> <tr> <td><b>MEAS</b></td> <td><b>UNIT</b></td> </tr> </table> | <b>AREA</b> | <b>0003</b> | 100.000 | m.sq | <b>MEAS</b>        | <b>UNIT</b> |
|                                                                                     |             | <b>AREA</b>                                                                                                                                                                     | <b>0003</b> |             |         |      |                    |             |
| 100.000                                                                             | m.sq        |                                                                                                                                                                                 |             |             |         |      |                    |             |
| <b>MEAS</b>                                                                         | <b>UNIT</b> |                                                                                                                                                                                 |             |             |         |      |                    |             |
| 2 Select a unit by pressing the [F1] to [F4] key.<br>Example: [F2](ha) key.         | [F2]        | <table border="1"> <tr> <td><b>AREA</b></td> <td><b>0003</b></td> </tr> <tr> <td>100.000</td> <td>m.sq</td> </tr> <tr> <td colspan="2">m.sq ha ft.sq acre</td> </tr> </table>   | <b>AREA</b> | <b>0003</b> | 100.000 | m.sq | m.sq ha ft.sq acre |             |
|                                                                                     |             | <b>AREA</b>                                                                                                                                                                     | <b>0003</b> |             |         |      |                    |             |
| 100.000                                                                             | m.sq        |                                                                                                                                                                                 |             |             |         |      |                    |             |
| m.sq ha ft.sq acre                                                                  |             |                                                                                                                                                                                 |             |             |         |      |                    |             |
|                                                                                     |             | <table border="1"> <tr> <td><b>AREA</b></td> <td><b>0003</b></td> </tr> <tr> <td>0.010</td> <td>ha</td> </tr> <tr> <td><b>MEAS</b></td> <td><b>UNIT</b></td> </tr> </table>     | <b>AREA</b> | <b>0003</b> | 0.010   | ha   | <b>MEAS</b>        | <b>UNIT</b> |
| <b>AREA</b>                                                                         | <b>0003</b> |                                                                                                                                                                                 |             |             |         |      |                    |             |
| 0.010                                                                               | ha          |                                                                                                                                                                                 |             |             |         |      |                    |             |
| <b>MEAS</b>                                                                         | <b>UNIT</b> |                                                                                                                                                                                 |             |             |         |      |                    |             |
| <p>● m.sq : square meter    ha : hectare    ft.sq : square feet    acre : acre.</p> |             |                                                                                                                                                                                 |             |             |         |      |                    |             |

### 6.1.5 Point to Line Measurement

This mode is used to obtain the coordinate data with the origin point  $A(0,0,0)$  and the line AB as N axis.

Place the 2 prisms at the points A and B on the line, and place the instrument at unknown point C. After measuring the 2 prisms, the coordinate data and the direction angle of the instrument will be calculated and restored.

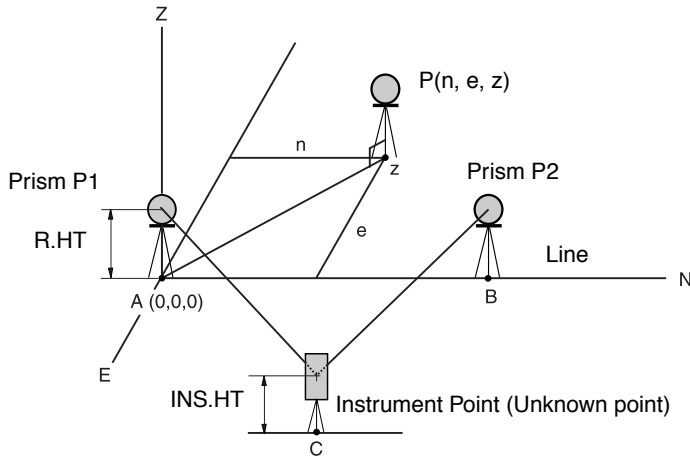

| Operating procedure                                                                  | Operation                       | Display                                                                                        |
|--------------------------------------------------------------------------------------|---------------------------------|------------------------------------------------------------------------------------------------|
| 1 After pressing the [MENU] key, press the [F4](P↓) key to get the menu on page 2/3. | [MENU]<br>[F4]                  | <b>MENU</b> 2/3<br><b>F1: PROGRAMS</b><br><b>F2: GRID FACTOR</b><br><b>F3: ILLUMINATION P↓</b> |
| 2 Press the [F1] key.                                                                | [F1]                            | <b>PROGRAMS</b> 1/2<br><b>F1: REM</b><br><b>F2: MLM</b><br><b>F3: Z COORD. P↓</b>              |
| 3 Press the [F4](P↓) key to get the PROGRAMS menu on page 2/2.                       | [F4]                            | <b>PROGRAMS</b> 2/2<br><b>F1: AREA</b><br><b>F2: POINT TO LINE</b><br><b>P↓</b>                |
| 4 Press the [F2] key.                                                                | [F2]                            | <b>INSTRUMENT HEIGHT</b><br><b>INPUT</b><br><b>INS.HT: 0.000 m</b><br><b>INPUT — — ENTER</b>   |
| 5 Press the [F1](INPUT) key and enter instrument height.                             | [F1]<br>Enter<br>INS.HT<br>[F4] | <b>REFLECTOR HEIGHT</b><br><b>INPUT</b><br><b>R.HT: 0.000 m</b><br><b>INPUT — — ENTER</b>      |
| 6 Press the [F1](INPUT) key and enter reflector A(P1) height.                        | [F1]<br>Enter R.HT<br>[F4]      | <b>POINT TO LINE</b><br><b>MEAS.P1</b><br><b>HD: m</b><br><b>&gt;Sight? [YES] [NO]</b>         |

|                                                                                                                                                                                                                                                                                                                                                                  |                                      |                                                                                                                                                                                                                                                                                                                                                                                 |
|------------------------------------------------------------------------------------------------------------------------------------------------------------------------------------------------------------------------------------------------------------------------------------------------------------------------------------------------------------------|--------------------------------------|---------------------------------------------------------------------------------------------------------------------------------------------------------------------------------------------------------------------------------------------------------------------------------------------------------------------------------------------------------------------------------|
| <p><b>7</b> Collimate prism P1 (Origin) and press [F3](YES) key.<br/>Measuring starts. *1)</p> <p>Input display of reflector B(P2) height will be shown.</p>                                                                                                                                                                                                     | <p>Collimate P1<br/>[F3]</p>         | <div style="border: 1px solid black; padding: 5px;"> <p><b>POINT TO LINE</b><br/><b>MEAS.P1</b><br/>HD*[n] &lt;&lt; m<br/>&gt;Measuring...</p> </div> <p style="text-align: center;">↓</p> <div style="border: 1px solid black; padding: 5px;"> <p><b>REFLECTOR HEIGHT</b><br/><b>INPUT</b><br/>R.HT: 0.000 m<br/>INPUT — — ENTER</p> </div>                                    |
| <p><b>8</b> Press [F1](INPUT) key and enter reflector B(P2) height.</p>                                                                                                                                                                                                                                                                                          | <p>[F1]<br/>Enter R. HT<br/>[F4]</p> | <div style="border: 1px solid black; padding: 5px;"> <p><b>POINT TO LINE</b><br/><b>MEAS.P2</b><br/>HD: m<br/>&gt;Sight? [YES] [NO]</p> </div>                                                                                                                                                                                                                                  |
| <p><b>9</b> Collimate prism B (P2)(Origin) and press the [F3](YES) key.<br/>Measuring starts. *1)</p> <p>The coordinate data and the direction angle of the instrument are calculated and restored.<br/>The result (The distance between A and B) will be displayed.<br/>dHD: Horizontal distance<br/>dVD: Vertical distance<br/>dSD: Slope distance *2) ,3)</p> | <p>Collimate P2<br/>[F3]</p>         | <div style="border: 1px solid black; padding: 5px;"> <p><b>POINT TO LINE</b><br/><b>MEAS.P2</b><br/>HD*[n] &lt;&lt; m<br/>&gt;Measuring...</p> </div> <p style="text-align: center;">↓</p> <div style="border: 1px solid black; padding: 5px;"> <p><b>DIST. (P1-P2) 1/2</b><br/>dHD: 10.000 m<br/>dVD: 0.000 m<br/>NEZ S.CO — P↓</p> </div>                                     |
| <p><b>10</b> Press [F1](NEZ) key to measure other points.</p>                                                                                                                                                                                                                                                                                                    | <p>[F1]</p>                          | <div style="border: 1px solid black; padding: 5px;"> <p><b>N: 0.000 m</b><br/><b>E: 0.000 m</b><br/><b>Z: 0.000 m</b><br/><b>EXIT — HT MEAS</b><br/>&gt;Measuring...</p> </div> <p style="text-align: center;">↓</p> <div style="border: 1px solid black; padding: 5px;"> <p><b>N: 3.456 m</b><br/><b>E: 5.432 m</b><br/><b>Z: 0.000 m</b><br/><b>EXIT — HT MEAS</b></p> </div> |
| <p><b>11</b> Collimate a prism and press [F4](MEAS) key.<br/>Coordinate measurement starts. *4)<br/>The result will be shown. *5)</p>                                                                                                                                                                                                                            | <p>Collimate P<br/>[F4]</p>          |                                                                                                                                                                                                                                                                                                                                                                                 |
| <p>*1) Measurement is Fine N-times measurement mode.<br/>*2) To show dSD, press [F4](P↓) key.<br/>*3) To show the new occupied data, press [F2](S.CO) key.<br/>*4) Measurement is Fine N-times measurement mode.<br/>*5) To return to previous mode, press [F1](EXIT) key.</p>                                                                                   |                                      |                                                                                                                                                                                                                                                                                                                                                                                 |

## 6.2 Setting the GRID FACTOR

GRID FACTOR can reset in this menu mode.

For more information, refer to Section 8.1.1 "Setting the GRID FACTOR"

| Operating procedure                                                                                                                                                                                                                               | Operation                   | Display                                                                                                                         |
|---------------------------------------------------------------------------------------------------------------------------------------------------------------------------------------------------------------------------------------------------|-----------------------------|---------------------------------------------------------------------------------------------------------------------------------|
| <b>1</b> After pressing the [MENU] key, press the [F4](P↓) key to get the menu on page 2.                                                                                                                                                         | [MENU]<br>[F4]              | <b>MENU</b> 2/3<br><b>F1: PROGRAMS</b><br><b>F2: GRID FACTOR</b><br><b>F3: ILLUMINATION P↓</b>                                  |
| <b>2</b> Press the [F2](GRID FACTOR) key.                                                                                                                                                                                                         | [F2]                        | <b>GRID FACTOR</b><br><b>=0.998843</b><br><br><b>&gt;MODIFY? [YES] [NO]</b>                                                     |
| <b>3</b> Press the [F3](YES) key.                                                                                                                                                                                                                 | [F3]                        | <b>GRID FACTOR</b><br><b>ELEV. →1000 m</b><br><b>SCALE:0.999000</b><br><b>INPUT — — ENTER</b><br><b>[---] [---] [CLR] [ENT]</b> |
| <b>4</b> Press the [F1] (INPUT) key and enter Elevation.<br>*1) Press the [F4](ENT) key.                                                                                                                                                          | [F1]<br>Enter ELEV.<br>[F4] |                                                                                                                                 |
| <b>5</b> Enter Scale Factor in the same way.                                                                                                                                                                                                      | [F1]<br>Enter Scale<br>[F4] | <b>GRID FACTOR</b><br><b>ELEV.:2000 m</b><br><b>SCALE→1.001000</b><br><b>INPUT — — ENTER</b>                                    |
| Grid Factor is displayed for 1 to 2 second and display returns to menu.                                                                                                                                                                           |                             | <b>GRID FACTOR</b><br><b>=1.000686</b>                                                                                          |
| <p>*1) Refer to Section 2.6 "How to Enter Alphanumeric characters".</p> <ul style="list-style-type: none"> <li>● Input Range :Elevation : -9,999 to +9,999 meter (-32,805 to +3,2805 ft, ft+in)<br/>Scale Factor: 0.990000 to 1.010000</li> </ul> |                             |                                                                                                                                 |

### 6.3 Setting Illumination of Display and Cross Hairs

Setting ON/OFF/LEVEL (1 to 9) for illumination of display (LCD) and reticle.

- Setting LEVEL (1 to 9) is only for reticle.

[Example setting] LEVEL:2 and turn on the illumination.

| Operating procedure                                                                       | Operation      | Display                                                                                        |
|-------------------------------------------------------------------------------------------|----------------|------------------------------------------------------------------------------------------------|
| <b>1</b> After pressing the [MENU] key, press the [F4](P↓) key to get the menu on page 2. | [MENU]<br>[F4] | <b>MENU</b> 2/3<br><b>F1: PROGRAMS</b><br><b>F2: GRID FACTOR</b><br><b>F3: ILLUMINATION P↓</b> |
| <b>2</b> Press the [F3] key.<br>The data previously set is shown.                         | [F3]           | <b>ILLUMINATION [OFF: 1]</b><br><b>F1: ON</b><br><b>F2: OFF</b><br><b>F3: LEVEL</b>            |
| <b>3</b> Press the [F3](LEVEL) key.                                                       | [F3]           | <b>ILLUMINATION [OFF: 1]</b><br><b>[LEVEL MODE]</b><br><br>↓      ↑      — <b>ENTER</b>        |
| <b>4</b> Press the [F2](↑) key, and then press the [F4](ENTER) key.                       | [F2]<br>[F4]   | <b>ILLUMINATION [OFF: 2]</b><br><b>F1: ON</b><br><b>F2: OFF</b><br><b>F3: LEVEL</b>            |
| <b>5</b> Press the [F1](ON) key.                                                          | [F1]           | <b>ILLUMINATION [ON: 2]</b><br><b>F1: ON</b><br><b>F2: OFF</b><br><b>F3: LEVEL</b>             |
| ● To return to previous mode, press the [ESC] key.                                        |                |                                                                                                |



## 6.4 Setting Mode 1

In this mode, the following settings are possible.

1. Setting Minimum Reading
  2. Auto Power off
  3. Vertical and Horizontal Angle Tilt Correction (Tilt ON/OFF)  
(GTS-239N has vertical angle tilt correction only.).
  4. Systematic Error of Instrument Correction
  5. Selecting battery type
  6. Heater ON/OFF
- This setting is memorized after power off.

### 6.4.1 Setting Minimum Reading

Select minimum display unit for angle measurement, coarse distance measurement mode.

- To select minimum display for fine measurement mode, see Chapter 16 "SELECTING MODE".

| Models                           | Angle Unit |                 |                  | Coarse mode<br>Distance unit   |
|----------------------------------|------------|-----------------|------------------|--------------------------------|
|                                  | Degree     | GON             | MIL              |                                |
| GTS-233N<br>GTS-235N<br>GTS-236N | 5" / 1"    | 1mgon / 0.2mgon | 0.1mil / 0.01mil | 10mm (0.02ft)/<br>1mm(0.005ft) |
| GTS-239N                         | 10" / 5"   | 2mgon / 1mgon   | 0.1mil / 0.01mil |                                |

[Example] Minimum angle : 5", Coarse : 1mm

| Operating procedure                                                                             | Operation              | Display                                                                                           |
|-------------------------------------------------------------------------------------------------|------------------------|---------------------------------------------------------------------------------------------------|
| <b>1</b> After pressing the [MENU] key, press the [F4](P↓) key twice to get the menu on page 3. | [MENU]<br>[F4]<br>[F4] | <b>MENU</b> 3 / 3<br><b>F1:PARAMETERS 1</b><br><b>F2:CONTRAST ADJ.</b><br>P↓                      |
| <b>2</b> Press the [F1] key.                                                                    | [F1]                   | <b>PARAMETERS 1</b><br><b>F1:MINIMUM READING</b><br><b>F2:AUTO POWER OFF</b><br><b>F3:TILT</b> P↓ |
| <b>3</b> Press the [F1] key.                                                                    | [F1]                   | <b>MINIMUM READING</b><br><b>F1:ANGLE</b><br><b>F2:COARSE</b>                                     |
| <b>4</b> Press the [F1] key.                                                                    | [F1]                   | <b>MINIMUM ANGLE</b><br>[F1: 1" ]<br><b>F2: 5"</b><br>ENTER                                       |
| <b>5</b> Press the [F2](5") key and press the [F4](ENTER) key.                                  | [F2]<br>[F4]           | <b>MINIMUM READING</b><br><b>F1:ANGLE</b><br><b>F2:COARSE</b>                                     |
| <b>6</b> Press the [F2] key.                                                                    | [F2]                   | <b>COARSE READING</b><br><b>F1: 1mm</b><br>[F2: 10mm]<br>ENTER                                    |

|                                                                                                      |              |                                                                                                                       |                                                                 |
|------------------------------------------------------------------------------------------------------|--------------|-----------------------------------------------------------------------------------------------------------------------|-----------------------------------------------------------------|
| 7 Press the [F1] key and press the [F4](ENTER) key.                                                  | [F1]<br>[F4] | <table border="1"> <tr> <td> <b>MINIMUM READING</b><br/> <b>F1: ANGLE</b><br/> <b>F2: COARSE</b> </td> </tr> </table> | <b>MINIMUM READING</b><br><b>F1: ANGLE</b><br><b>F2: COARSE</b> |
| <b>MINIMUM READING</b><br><b>F1: ANGLE</b><br><b>F2: COARSE</b>                                      |              |                                                                                                                       |                                                                 |
| <ul style="list-style-type: none"> <li>● To return to previous mode, press the [ESC] key.</li> </ul> |              |                                                                                                                       |                                                                 |

### 6.4.2 Auto Power Off

If no key operation is given or no process of measurement is performed for more than 30 minutes ( No change exceeding 30" has occurred during horizontal angle or vertical angle measurement.), the power turns off automatically. If the instrument is set at distance measurement mode ( No change in distance exceeding 10cm has occurred during distance measurement), the mode changes to angle measurement automatically in case that the instrument does not operate for approximately 10 minutes, and the power turns off after 20 minutes.

| Operating procedure                                                                      | Operation              | Display                                                                                                                                                                                                                                                                         |                             |              |                            |  |                           |  |                 |              |
|------------------------------------------------------------------------------------------|------------------------|---------------------------------------------------------------------------------------------------------------------------------------------------------------------------------------------------------------------------------------------------------------------------------|-----------------------------|--------------|----------------------------|--|---------------------------|--|-----------------|--------------|
| 1 After pressing the [MENU] key, press the [F4](P↓) key twice to get the menu on page 3. | [MENU]<br>[F4]<br>[F4] | <table border="1"> <tr> <td> <b>MENU</b> </td> <td> <b>3 / 3</b> </td> </tr> <tr> <td> <b>F1: PARAMETERS 1</b> </td> <td> </td> </tr> <tr> <td> <b>F2: CONTRAST ADJ.</b> </td> <td> </td> </tr> <tr> <td> </td> <td> <b>P↓</b> </td> </tr> </table>                             | <b>MENU</b>                 | <b>3 / 3</b> | <b>F1: PARAMETERS 1</b>    |  | <b>F2: CONTRAST ADJ.</b>  |  |                 | <b>P↓</b>    |
| <b>MENU</b>                                                                              | <b>3 / 3</b>           |                                                                                                                                                                                                                                                                                 |                             |              |                            |  |                           |  |                 |              |
| <b>F1: PARAMETERS 1</b>                                                                  |                        |                                                                                                                                                                                                                                                                                 |                             |              |                            |  |                           |  |                 |              |
| <b>F2: CONTRAST ADJ.</b>                                                                 |                        |                                                                                                                                                                                                                                                                                 |                             |              |                            |  |                           |  |                 |              |
|                                                                                          | <b>P↓</b>              |                                                                                                                                                                                                                                                                                 |                             |              |                            |  |                           |  |                 |              |
| 2 Press the [F1] key.                                                                    | [F1]                   | <table border="1"> <tr> <td> <b>PARAMETERS 1</b> </td> <td> <b>1 / 2</b> </td> </tr> <tr> <td> <b>F1: MINIMUM READING</b> </td> <td> </td> </tr> <tr> <td> <b>F2: AUTO POWER OFF</b> </td> <td> </td> </tr> <tr> <td> <b>F3: TILT</b> </td> <td> <b>P↓</b> </td> </tr> </table> | <b>PARAMETERS 1</b>         | <b>1 / 2</b> | <b>F1: MINIMUM READING</b> |  | <b>F2: AUTO POWER OFF</b> |  | <b>F3: TILT</b> | <b>P↓</b>    |
| <b>PARAMETERS 1</b>                                                                      | <b>1 / 2</b>           |                                                                                                                                                                                                                                                                                 |                             |              |                            |  |                           |  |                 |              |
| <b>F1: MINIMUM READING</b>                                                               |                        |                                                                                                                                                                                                                                                                                 |                             |              |                            |  |                           |  |                 |              |
| <b>F2: AUTO POWER OFF</b>                                                                |                        |                                                                                                                                                                                                                                                                                 |                             |              |                            |  |                           |  |                 |              |
| <b>F3: TILT</b>                                                                          | <b>P↓</b>              |                                                                                                                                                                                                                                                                                 |                             |              |                            |  |                           |  |                 |              |
| 3 Press the [F2] key.<br>The data previously set is shown.                               | [F2]                   | <table border="1"> <tr> <td> <b>AUTO POWER OFF [OFF]</b> </td> <td> </td> </tr> <tr> <td> <b>F1: ON</b> </td> <td> </td> </tr> <tr> <td> <b>F2: OFF</b> </td> <td> </td> </tr> <tr> <td> </td> <td> <b>ENTER</b> </td> </tr> </table>                                           | <b>AUTO POWER OFF [OFF]</b> |              | <b>F1: ON</b>              |  | <b>F2: OFF</b>            |  |                 | <b>ENTER</b> |
| <b>AUTO POWER OFF [OFF]</b>                                                              |                        |                                                                                                                                                                                                                                                                                 |                             |              |                            |  |                           |  |                 |              |
| <b>F1: ON</b>                                                                            |                        |                                                                                                                                                                                                                                                                                 |                             |              |                            |  |                           |  |                 |              |
| <b>F2: OFF</b>                                                                           |                        |                                                                                                                                                                                                                                                                                 |                             |              |                            |  |                           |  |                 |              |
|                                                                                          | <b>ENTER</b>           |                                                                                                                                                                                                                                                                                 |                             |              |                            |  |                           |  |                 |              |
| 4 Press the [F1](ON) key or [F2](OFF) key, and press the [F4](ENTER) key.                | [F1] or [F2]<br>[F4]   |                                                                                                                                                                                                                                                                                 |                             |              |                            |  |                           |  |                 |              |

### 6.4.3 Vertical and Horizontal Angle Tilt correction ( Tilt ON/OFF)

(GTS-239N has vertical angle tilt correction only.)

In case the instrument is used in an unstable situation, constant indexing of vertical and horizontal angle may be impossible. In this case, the function of tilt correction can be stopped by selecting TILT OFF. It has been set to X,Y (V/H) TILT ON at the factory.

- This setting is memorized after powering off.

| Operating procedure                                                                      | Operation              | Display                                                                                                                                                                                                                                                                         |                     |              |                            |  |                           |  |                 |           |
|------------------------------------------------------------------------------------------|------------------------|---------------------------------------------------------------------------------------------------------------------------------------------------------------------------------------------------------------------------------------------------------------------------------|---------------------|--------------|----------------------------|--|---------------------------|--|-----------------|-----------|
| 1 After pressing the [MENU] key, press the [F4](P↓) key twice to get the menu on page 3. | [MENU]<br>[F4]<br>[F4] | <table border="1"> <tr> <td> <b>MENU</b> </td> <td> <b>3 / 3</b> </td> </tr> <tr> <td> <b>F1: PARAMETERS 1</b> </td> <td> </td> </tr> <tr> <td> <b>F2: CONTRAST ADJ.</b> </td> <td> </td> </tr> <tr> <td> </td> <td> <b>P↓</b> </td> </tr> </table>                             | <b>MENU</b>         | <b>3 / 3</b> | <b>F1: PARAMETERS 1</b>    |  | <b>F2: CONTRAST ADJ.</b>  |  |                 | <b>P↓</b> |
| <b>MENU</b>                                                                              | <b>3 / 3</b>           |                                                                                                                                                                                                                                                                                 |                     |              |                            |  |                           |  |                 |           |
| <b>F1: PARAMETERS 1</b>                                                                  |                        |                                                                                                                                                                                                                                                                                 |                     |              |                            |  |                           |  |                 |           |
| <b>F2: CONTRAST ADJ.</b>                                                                 |                        |                                                                                                                                                                                                                                                                                 |                     |              |                            |  |                           |  |                 |           |
|                                                                                          | <b>P↓</b>              |                                                                                                                                                                                                                                                                                 |                     |              |                            |  |                           |  |                 |           |
| 2 Press the [F1] key.                                                                    | [F1]                   | <table border="1"> <tr> <td> <b>PARAMETERS 1</b> </td> <td> <b>1 / 2</b> </td> </tr> <tr> <td> <b>F1: MINIMUM READING</b> </td> <td> </td> </tr> <tr> <td> <b>F2: AUTO POWER OFF</b> </td> <td> </td> </tr> <tr> <td> <b>F3: TILT</b> </td> <td> <b>P↓</b> </td> </tr> </table> | <b>PARAMETERS 1</b> | <b>1 / 2</b> | <b>F1: MINIMUM READING</b> |  | <b>F2: AUTO POWER OFF</b> |  | <b>F3: TILT</b> | <b>P↓</b> |
| <b>PARAMETERS 1</b>                                                                      | <b>1 / 2</b>           |                                                                                                                                                                                                                                                                                 |                     |              |                            |  |                           |  |                 |           |
| <b>F1: MINIMUM READING</b>                                                               |                        |                                                                                                                                                                                                                                                                                 |                     |              |                            |  |                           |  |                 |           |
| <b>F2: AUTO POWER OFF</b>                                                                |                        |                                                                                                                                                                                                                                                                                 |                     |              |                            |  |                           |  |                 |           |
| <b>F3: TILT</b>                                                                          | <b>P↓</b>              |                                                                                                                                                                                                                                                                                 |                     |              |                            |  |                           |  |                 |           |

|                                                                                                                              |                   |                                                                                                        |
|------------------------------------------------------------------------------------------------------------------------------|-------------------|--------------------------------------------------------------------------------------------------------|
| <b>3</b> Press the [F3] key.<br>The data previously set is shown.<br>If already ON, the display shows tilt correction value. | [F3]              | <b>TILT SENSOR: [XY-ON]</b><br><b>X: 0°02'10"</b><br><b>Y: 0°03'00"</b><br><b>X-ON XY-ON OFF ENTER</b> |
| <b>4</b> Press the [F1](X-ON) key or [F2](XY-ON) or [F3](OFF) key, and press the [F4](ENTER) key.                            | [F1]~[F3]<br>[F4] |                                                                                                        |

#### 6.4.4 Systematic Error of Instrument Correction (only for GTS-233N/235N/236N)

Setting ON/OFF for error correction of collimation and horizontal axis for angle measurement.

Note: Perform this item after complete Section 17.5 "Adjustment of Compensation Systematic Error of Instrument".

| Operating procedure                                                                             | Operation              | Display                                                                                                |
|-------------------------------------------------------------------------------------------------|------------------------|--------------------------------------------------------------------------------------------------------|
| <b>1</b> After pressing the [MENU] key, press the [F4](P↓) key twice to get the menu on page 2. | [MENU]<br>[F4]<br>[F4] | <b>MENU 3/3</b><br><b>F1:PARAMETERS 1</b><br><b>F2:CONTRAST ADJ.</b><br><b>P↓</b>                      |
| <b>2</b> Press the [F1] key.                                                                    | [F1]                   | <b>PARAMETERS 1 1/2</b><br><b>F1:MINIMUM READING</b><br><b>F2:AUTO POWER OFF</b><br><b>F3:TILT P↓</b>  |
| <b>3</b> Press the [F4] key.                                                                    | [F4]                   | <b>PARAMETERS 1 2/2</b><br><b>F1:ERROR CORRECTION</b><br><b>F2:BATTERY TYPE</b><br><b>F3:HEATER P↓</b> |
| <b>4</b> Press the [F1] key.<br>The data previously set is shown.                               | [F1]                   | <b>ERROR CORR. [OFF]</b><br><b>F1:ON</b><br><b>F2:OFF</b><br><b>ENTER</b>                              |
| <b>5</b> Press the [F1](ON) key or [F2](OFF) key, and press the [F4](ENTER) key.                | [F1] or [F2]<br>[F4]   |                                                                                                        |

#### 6.4.5 Selecting Battery Type

On-board battery BT-32Q can be also available for GTS-230N series. When you use BT-32Q (Ni-Cd) battery, select [Ni-Cd] type of battery in this parameters 1 menu.

If you select wrong type of battery, the battery remaining display may work incorrectly.

BT-52QA : Ni-MH battery type, BT-32Q : Ni-Cd battery type.

| Operating procedure                                                                               | Operation              | Display                                                                                                |
|---------------------------------------------------------------------------------------------------|------------------------|--------------------------------------------------------------------------------------------------------|
| <b>1</b> After pressing the [MENU] key, press the [F4](P↓) key twice to get the menu on page 3/3. | [MENU]<br>[F4]<br>[F4] | <b>MENU 3/3</b><br><b>F1:PARAMETERS 1</b><br><b>F2:CONTRAST ADJ.</b><br><b>P↓</b>                      |
| <b>2</b> Press the [F1] key and press the [F4](P↓) key to get the menu on page 2.                 | [F1]<br>[F4]           | <b>PARAMETERS 1 2/2</b><br><b>F1:ERROR CORRECTION</b><br><b>F2:BATTERY TYPE</b><br><b>F3:HEATER P↓</b> |

|                                                                                              |              |                                                                                                                                                                                       |
|----------------------------------------------------------------------------------------------|--------------|---------------------------------------------------------------------------------------------------------------------------------------------------------------------------------------|
| <b>3</b> Press the [F2] key.                                                                 | [F2]         | <div style="border: 1px solid black; padding: 5px;"> <b>BATTERY TYPE</b><br/>         [F1:Ni-MH ]<br/> <b>F2:Ni-Cd</b><br/> <div style="text-align: right;"><b>ENTER</b></div> </div> |
| <b>4</b> Press the [F2] key to select Ni-Cd battery type.<br>Then press the [F4](ENTER) key. | [F2]<br>[F4] |                                                                                                                                                                                       |

### 6.4.6 Heater ON/OFF

The heater option for both display units can be turned OFF or ON.

| Operating procedure                                                                             | Operation              | Display                                                                                                                                                                                                                                        |
|-------------------------------------------------------------------------------------------------|------------------------|------------------------------------------------------------------------------------------------------------------------------------------------------------------------------------------------------------------------------------------------|
| <b>1</b> After pressing the [MENU] key, press the [F4](P↓) key twice to get the menu on page 2. | [MENU]<br>[F4]<br>[F4] | <div style="border: 1px solid black; padding: 5px;"> <b>MENU</b> <span style="float: right;">3/3</span><br/> <b>F1:PARAMETERS 1</b><br/> <b>F2:CONTRAST ADJ.</b><br/> <div style="text-align: right;">P↓</div> </div>                          |
| <b>2</b> Press the [F1] key.                                                                    | [F1]                   | <div style="border: 1px solid black; padding: 5px;"> <b>PARAMETERS 1</b> <span style="float: right;">1/2</span><br/> <b>F1:MINIMUM READING</b><br/> <b>F2:AUTO POWER OFF</b><br/> <b>F3:TILT</b> <span style="float: right;">P↓</span> </div>  |
| <b>3</b> Press the [F4] key.                                                                    | [F4]                   | <div style="border: 1px solid black; padding: 5px;"> <b>PARAMETERS 1</b> <span style="float: right;">2/2</span><br/> <b>F1:ERROR CORRECTION</b><br/> <b>F2:BATTERY TYPE</b><br/> <b>F3:HEATER</b> <span style="float: right;">P↓</span> </div> |
| <b>4</b> Press the [F3] key.<br>The data previously set is shown.                               | [F3]                   | <div style="border: 1px solid black; padding: 5px;"> <b>HEATER</b> <span style="float: right;">[OFF]</span><br/> <b>F1:ON</b><br/> <b>F2:OFF</b><br/> <div style="text-align: right;"><b>ENTER</b></div> </div>                                |
| <b>5</b> Press the [F1](ON) key or [F2](OFF) key, and press the [F4](ENTER) key.                | [F1] or [F2]<br>[F4]   |                                                                                                                                                                                                                                                |

## 6.5 Setting Contrast of Display

Setting level for contrast of display (LCD)

| Operating procedure                                                                             | Operation              | Display                                                                                                                                                                                                               |
|-------------------------------------------------------------------------------------------------|------------------------|-----------------------------------------------------------------------------------------------------------------------------------------------------------------------------------------------------------------------|
| <b>1</b> After pressing the [MENU] key, press the [F4](P↓) key twice to get the menu on page 3. | [MENU]<br>[F4]<br>[F4] | <div style="border: 1px solid black; padding: 5px;"> <b>MENU</b> <span style="float: right;">3/3</span><br/> <b>F1:PARAMETERS 1</b><br/> <b>F2:CONTRAST ADJ.</b><br/> <div style="text-align: right;">P↓</div> </div> |
| <b>2</b> Press the [F2] key.                                                                    | [F2]                   | <div style="border: 1px solid black; padding: 5px;"> <b>CONTRAST ADJUSTMENT</b><br/> <b>LEVEL: 4</b><br/> <div style="text-align: center;">↓   ↑   —</div> <div style="text-align: right;"><b>ENTER</b></div> </div>  |
| <b>3</b> Press the [F1](↓) key or [F2](↑) key, and press the [F4](ENTER) key.                   | [F1]or [F2]<br>[F4]    |                                                                                                                                                                                                                       |

## 6.6 ROAD

### ● Road menu operation

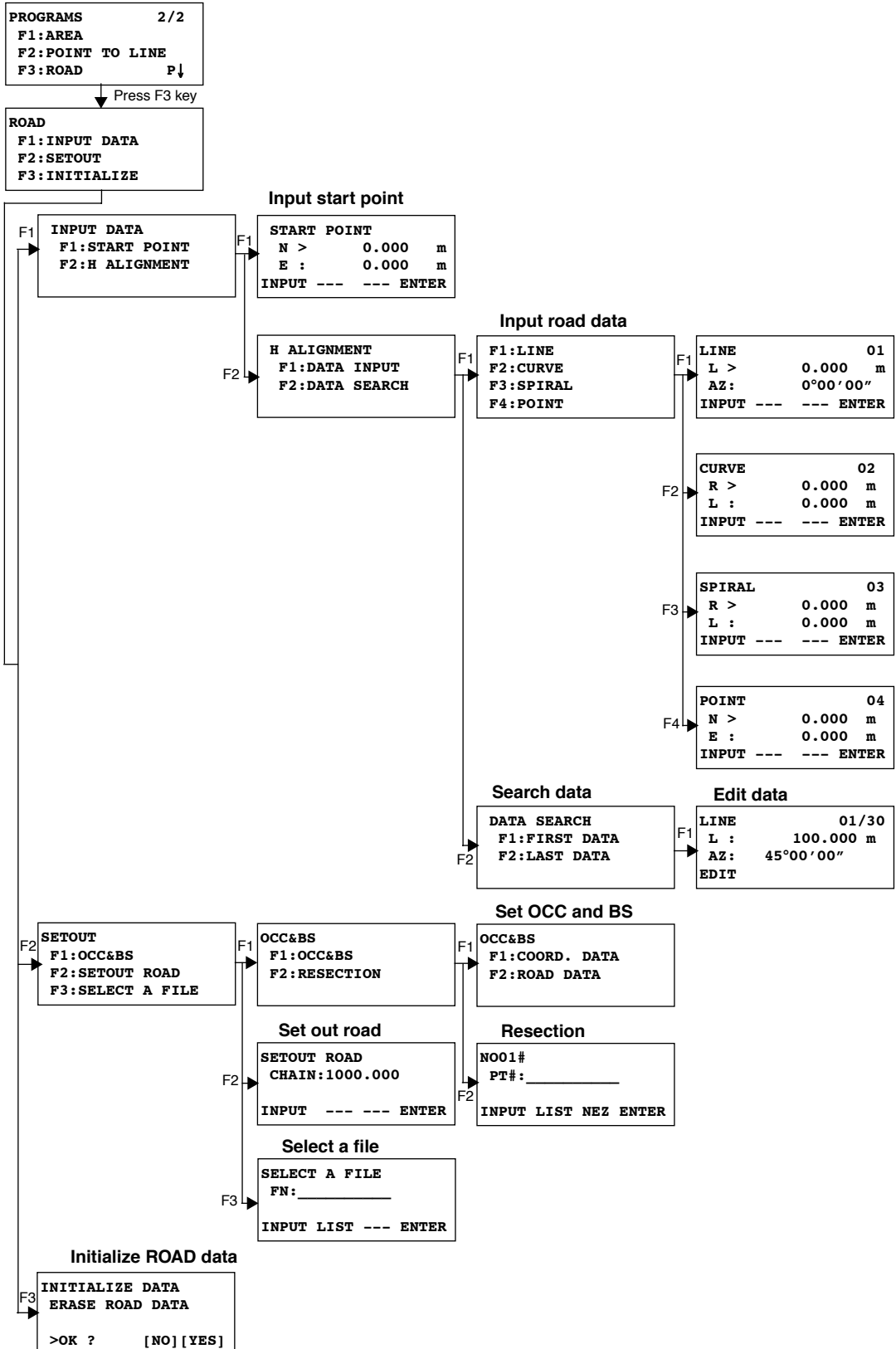

### 6.6.1 Input Start Point

To input the start point, carry out the following operating procedure.

| Operating procedure                                                                                                                                                                                                                                                                                                                                                                                                                                                                                                                                   | Operation                      | Display                                                                                                                               |
|-------------------------------------------------------------------------------------------------------------------------------------------------------------------------------------------------------------------------------------------------------------------------------------------------------------------------------------------------------------------------------------------------------------------------------------------------------------------------------------------------------------------------------------------------------|--------------------------------|---------------------------------------------------------------------------------------------------------------------------------------|
| <b>1</b> After pressing the [MENU] key, press the [F4](P↓), [F1], [F4] key to get the programs menu on page 2/2.                                                                                                                                                                                                                                                                                                                                                                                                                                      | [MENU]<br>[F4]<br>[F1]<br>[F4] | <pre> <b>PROGRAMS</b>                2/2 <b>F1:AREA</b> <b>F2:POINT TO LINE</b> <b>F3:ROAD</b>                    P↓           </pre> |
| <b>2</b> Press the [F3], [F1], [F1] key.<br>(Refer to "Input start point" on page 6-22.)                                                                                                                                                                                                                                                                                                                                                                                                                                                              | [F3]<br>[F1]<br>[F1]           | <pre> <b>START POINT</b>   N &gt;      0.000  m   E :      0.000  m <b>INPUT ---  --- ENTER</b>           </pre>                      |
| <b>3</b> Input coord N, E.<br><b>4</b> Press the [ENT] key.                                                                                                                                                                                                                                                                                                                                                                                                                                                                                           | Input coord<br>[ENT]           | <pre> <b>START POINT</b> <b>CHAIN &gt; 0.000  m</b> <b>INTERVAL:100.000 m</b> <b>INPUT ---  --- ENTER</b>           </pre>            |
| <b>5</b> Input value data CHAIN, INTERVAL.<br><b>6</b> Press the [ENT] key.                                                                                                                                                                                                                                                                                                                                                                                                                                                                           | Input data<br>[ENT]            | <pre>           &lt;SET!&gt;           </pre> <pre> <b>INPUT DATA</b> <b>F1:START POINT</b> <b>F2:H ALIGNMENT</b>           </pre>    |
| <ul style="list-style-type: none"> <li>● For [ROAD], in addition to the "Start Point" and "Road Data" input files, other files necessary for the calculations are created. Consequently, if the free area of the memory reaches 10% or less, a "MEMORY POOR" warning message is displayed. (In this case, the instrument can still be operated.)</li> <li>● CHAIN and INTERVAL input range<br/> <math>-50,000\text{m} \leq \text{CHAIN} \leq +500,000\text{m}</math><br/> <math>0\text{m} &lt; \text{INTERVAL} \leq +5,000\text{m}</math> </li> </ul> |                                |                                                                                                                                       |

## 6.6.2 Input Road Data

[ROAD] is made up of four types of components: LINE, CURVE, SPIRAL and POINT.  
To input the required components, carry out the following operating procedure.

| Operating procedure                                                                                                                                                                                                                                                                                                                                                                                                                                                        | Operation                      | Display                                                                                                                                                                                                                             |                 |       |                  |  |                          |  |                  |    |
|----------------------------------------------------------------------------------------------------------------------------------------------------------------------------------------------------------------------------------------------------------------------------------------------------------------------------------------------------------------------------------------------------------------------------------------------------------------------------|--------------------------------|-------------------------------------------------------------------------------------------------------------------------------------------------------------------------------------------------------------------------------------|-----------------|-------|------------------|--|--------------------------|--|------------------|----|
| 1 After pressing the [MENU] key, press the [F4](P↓), [F1], [F4] key to get the programs menu on page 2/2.                                                                                                                                                                                                                                                                                                                                                                  | [MENU]<br>[F4]<br>[F1]<br>[F4] | <table border="1"> <tr> <td><b>PROGRAMS</b></td> <td>2 / 2</td> </tr> <tr> <td><b>F1: AREA</b></td> <td></td> </tr> <tr> <td><b>F2: POINT TO LINE</b></td> <td></td> </tr> <tr> <td><b>F3: ROAD</b></td> <td>P↓</td> </tr> </table> | <b>PROGRAMS</b> | 2 / 2 | <b>F1: AREA</b>  |  | <b>F2: POINT TO LINE</b> |  | <b>F3: ROAD</b>  | P↓ |
| <b>PROGRAMS</b>                                                                                                                                                                                                                                                                                                                                                                                                                                                            | 2 / 2                          |                                                                                                                                                                                                                                     |                 |       |                  |  |                          |  |                  |    |
| <b>F1: AREA</b>                                                                                                                                                                                                                                                                                                                                                                                                                                                            |                                |                                                                                                                                                                                                                                     |                 |       |                  |  |                          |  |                  |    |
| <b>F2: POINT TO LINE</b>                                                                                                                                                                                                                                                                                                                                                                                                                                                   |                                |                                                                                                                                                                                                                                     |                 |       |                  |  |                          |  |                  |    |
| <b>F3: ROAD</b>                                                                                                                                                                                                                                                                                                                                                                                                                                                            | P↓                             |                                                                                                                                                                                                                                     |                 |       |                  |  |                          |  |                  |    |
| 2 Press the [F3], [F1], [F2],[F1] key.<br>(Refer to "Input road data" on page 6-22.)                                                                                                                                                                                                                                                                                                                                                                                       | [F3]<br>[F1]<br>[F2]<br>[F1]   | <table border="1"> <tr> <td><b>F1: LINE</b></td> <td></td> </tr> <tr> <td><b>F2: CURVE</b></td> <td></td> </tr> <tr> <td><b>F3: SPIRAL</b></td> <td></td> </tr> <tr> <td><b>F4: POINT</b></td> <td></td> </tr> </table>             | <b>F1: LINE</b> |       | <b>F2: CURVE</b> |  | <b>F3: SPIRAL</b>        |  | <b>F4: POINT</b> |    |
| <b>F1: LINE</b>                                                                                                                                                                                                                                                                                                                                                                                                                                                            |                                |                                                                                                                                                                                                                                     |                 |       |                  |  |                          |  |                  |    |
| <b>F2: CURVE</b>                                                                                                                                                                                                                                                                                                                                                                                                                                                           |                                |                                                                                                                                                                                                                                     |                 |       |                  |  |                          |  |                  |    |
| <b>F3: SPIRAL</b>                                                                                                                                                                                                                                                                                                                                                                                                                                                          |                                |                                                                                                                                                                                                                                     |                 |       |                  |  |                          |  |                  |    |
| <b>F4: POINT</b>                                                                                                                                                                                                                                                                                                                                                                                                                                                           |                                |                                                                                                                                                                                                                                     |                 |       |                  |  |                          |  |                  |    |
| <ul style="list-style-type: none"> <li>● The amount of input data varies depending on the type of data, up to a maximum of 30.<br/>(In the case of POINT input only, the maximum is 9 points including end point.)</li> <li>● An error may occur when entering a combination of POINT and other components if the amount of data entered exceeds the maximum amount allowed for internal calculations. If this happens, please reduce the amount of input data.</li> </ul> |                                |                                                                                                                                                                                                                                     |                 |       |                  |  |                          |  |                  |    |

- Input LINE data

| Operating procedure                                                                       | Operation        | Display                                                                                                                                                                                                                               |                                                                                                             |                     |                  |           |                   |          |                  |               |
|-------------------------------------------------------------------------------------------|------------------|---------------------------------------------------------------------------------------------------------------------------------------------------------------------------------------------------------------------------------------|-------------------------------------------------------------------------------------------------------------|---------------------|------------------|-----------|-------------------|----------|------------------|---------------|
| 1 To input LINE data, press the [F1] key. *1)                                             | [F1]             | <table border="1"> <tr> <td><b>F1: LINE</b></td> <td></td> </tr> <tr> <td><b>F2: CURVE</b></td> <td></td> </tr> <tr> <td><b>F3: SPIRAL</b></td> <td></td> </tr> <tr> <td><b>F4: POINT</b></td> <td></td> </tr> </table>               | <b>F1: LINE</b>                                                                                             |                     | <b>F2: CURVE</b> |           | <b>F3: SPIRAL</b> |          | <b>F4: POINT</b> |               |
| <b>F1: LINE</b>                                                                           |                  |                                                                                                                                                                                                                                       |                                                                                                             |                     |                  |           |                   |          |                  |               |
| <b>F2: CURVE</b>                                                                          |                  |                                                                                                                                                                                                                                       |                                                                                                             |                     |                  |           |                   |          |                  |               |
| <b>F3: SPIRAL</b>                                                                         |                  |                                                                                                                                                                                                                                       |                                                                                                             |                     |                  |           |                   |          |                  |               |
| <b>F4: POINT</b>                                                                          |                  |                                                                                                                                                                                                                                       |                                                                                                             |                     |                  |           |                   |          |                  |               |
| 2 Input LENGTH.                                                                           | Input            | <table border="1"> <tr> <td><b>LINE</b></td> <td>01</td> </tr> <tr> <td><b>L &gt;</b></td> <td>0.000 m</td> </tr> <tr> <td><b>AZ:</b></td> <td>0°00'00"</td> </tr> <tr> <td><b>INPUT</b></td> <td>--- --- ENTER</td> </tr> </table>   | <b>LINE</b>                                                                                                 | 01                  | <b>L &gt;</b>    | 0.000 m   | <b>AZ:</b>        | 0°00'00" | <b>INPUT</b>     | --- --- ENTER |
| <b>LINE</b>                                                                               | 01               |                                                                                                                                                                                                                                       |                                                                                                             |                     |                  |           |                   |          |                  |               |
| <b>L &gt;</b>                                                                             | 0.000 m          |                                                                                                                                                                                                                                       |                                                                                                             |                     |                  |           |                   |          |                  |               |
| <b>AZ:</b>                                                                                | 0°00'00"         |                                                                                                                                                                                                                                       |                                                                                                             |                     |                  |           |                   |          |                  |               |
| <b>INPUT</b>                                                                              | --- --- ENTER    |                                                                                                                                                                                                                                       |                                                                                                             |                     |                  |           |                   |          |                  |               |
| 3 Press the [ENT] key.                                                                    | LENGTH<br>[ENT]  | <table border="1"> <tr> <td><b>LINE</b></td> <td>01</td> </tr> <tr> <td><b>L :</b></td> <td>100.000 m</td> </tr> <tr> <td><b>AZ&gt;</b></td> <td>0°00'00"</td> </tr> <tr> <td><b>INPUT</b></td> <td>--- --- ENTER</td> </tr> </table> | <b>LINE</b>                                                                                                 | 01                  | <b>L :</b>       | 100.000 m | <b>AZ&gt;</b>     | 0°00'00" | <b>INPUT</b>     | --- --- ENTER |
| <b>LINE</b>                                                                               | 01               |                                                                                                                                                                                                                                       |                                                                                                             |                     |                  |           |                   |          |                  |               |
| <b>L :</b>                                                                                | 100.000 m        |                                                                                                                                                                                                                                       |                                                                                                             |                     |                  |           |                   |          |                  |               |
| <b>AZ&gt;</b>                                                                             | 0°00'00"         |                                                                                                                                                                                                                                       |                                                                                                             |                     |                  |           |                   |          |                  |               |
| <b>INPUT</b>                                                                              | --- --- ENTER    |                                                                                                                                                                                                                                       |                                                                                                             |                     |                  |           |                   |          |                  |               |
| 4 Input AZIMUTH.                                                                          | Input            | <p style="text-align: center;">⋮</p>                                                                                                                                                                                                  |                                                                                                             |                     |                  |           |                   |          |                  |               |
| 5 Press the [ENT] key.                                                                    | AZIMUTH<br>[ENT] |                                                                                                                                                                                                                                       | <table border="1"> <tr> <td colspan="2" style="text-align: center;"><b>&lt;SET!&gt;</b></td> </tr> </table> | <b>&lt;SET!&gt;</b> |                  |           |                   |          |                  |               |
| <b>&lt;SET!&gt;</b>                                                                       |                  |                                                                                                                                                                                                                                       |                                                                                                             |                     |                  |           |                   |          |                  |               |
| *1) The number at the top right of the screen shows the amount of data currently entered. |                  |                                                                                                                                                                                                                                       |                                                                                                             |                     |                  |           |                   |          |                  |               |

## ● Input CURVE data

| Operating procedure                                                                                                                                                                                                                                                                                    | Operation                                                                                                                                     | Display                                                                                                                                                                                                                                                                                                                                                                                                                                                                                                                                                                                                                                                                                                                                                                                                                                                                                                                                                                                                                                                                                                                                                                                                                                                                    |
|--------------------------------------------------------------------------------------------------------------------------------------------------------------------------------------------------------------------------------------------------------------------------------------------------------|-----------------------------------------------------------------------------------------------------------------------------------------------|----------------------------------------------------------------------------------------------------------------------------------------------------------------------------------------------------------------------------------------------------------------------------------------------------------------------------------------------------------------------------------------------------------------------------------------------------------------------------------------------------------------------------------------------------------------------------------------------------------------------------------------------------------------------------------------------------------------------------------------------------------------------------------------------------------------------------------------------------------------------------------------------------------------------------------------------------------------------------------------------------------------------------------------------------------------------------------------------------------------------------------------------------------------------------------------------------------------------------------------------------------------------------|
| <p><b>1</b> To input CURVE data, press the [F2] key. *1)</p> <p><b>2</b> Input RADIUS.</p> <p><b>3</b> Press the [ENT] key.</p> <p><b>4</b> Input LENGTH.</p> <p><b>5</b> Press the [ENT] key.</p> <p><b>6</b> Select TURN(direction of turn): RIGHT or LEFT.</p> <p><b>7</b> Press the [ENT] key.</p> | <p>[F2]</p> <p>Input<br/>RADIUS<br/>[ENT]</p> <p>Input<br/>LENGTH<br/>[ENT]</p> <p>Select<br/>[F1](LEFT)<br/>or<br/>[F2](RIGHT)<br/>[ENT]</p> | <div data-bbox="869 173 1202 306" style="border: 1px solid black; padding: 5px;"> <p><b>F1:LINE</b><br/><b>F2:CURVE</b><br/><b>F3:SPIRAL</b><br/><b>F4:POINT</b></p> </div> <div data-bbox="869 319 1202 453" style="border: 1px solid black; padding: 5px;"> <p><b>CURVE</b> <span style="float:right">02</span><br/> <b>R &gt;</b> <span style="float:right">0.000 m</span><br/> <b>L :</b> <span style="float:right">0.000 m</span><br/> <b>INPUT --- --- ENTER</b></p> </div> <div data-bbox="869 466 1202 599" style="border: 1px solid black; padding: 5px;"> <p><b>CURVE</b> <span style="float:right">02</span><br/> <b>R :</b> <span style="float:right">100.000 m</span><br/> <b>L &gt;</b> <span style="float:right">0.000 m</span><br/> <b>INPUT --- --- ENTER</b></p> </div> <div data-bbox="869 613 1202 746" style="border: 1px solid black; padding: 5px; text-align: center;"> <p>.....</p> </div> <div data-bbox="869 759 1202 892" style="border: 1px solid black; padding: 5px;"> <p><b>CURVE</b> <span style="float:right">02</span><br/> <b>TURN &gt; RIGHT</b><br/> <b>LEFT RIGHT --- ENTER</b></p> </div> <div data-bbox="869 919 1202 1052" style="border: 1px solid black; padding: 5px; text-align: center;"> <p><b>&lt;SET!&gt;</b></p> </div> |
| <p>*1) CURVE cannot be input as the first data.</p>                                                                                                                                                                                                                                                    |                                                                                                                                               |                                                                                                                                                                                                                                                                                                                                                                                                                                                                                                                                                                                                                                                                                                                                                                                                                                                                                                                                                                                                                                                                                                                                                                                                                                                                            |



## ● Input SPIRAL data

| Operating procedure                                                                                                                                                                                                                                                                                                                                                                                            | Operation                                                                                                                                                                                               | Display                                                                                                                                                                                                                                                                                                                                                                                                                                                                                                                                                                                                                                                                                                                                                                                                                                                                                                                                                                                                     |
|----------------------------------------------------------------------------------------------------------------------------------------------------------------------------------------------------------------------------------------------------------------------------------------------------------------------------------------------------------------------------------------------------------------|---------------------------------------------------------------------------------------------------------------------------------------------------------------------------------------------------------|-------------------------------------------------------------------------------------------------------------------------------------------------------------------------------------------------------------------------------------------------------------------------------------------------------------------------------------------------------------------------------------------------------------------------------------------------------------------------------------------------------------------------------------------------------------------------------------------------------------------------------------------------------------------------------------------------------------------------------------------------------------------------------------------------------------------------------------------------------------------------------------------------------------------------------------------------------------------------------------------------------------|
| <p><b>1</b> To input SPIRAL data, press the [F3] key. *1)</p> <p><b>2</b> Input RADIUS.</p> <p><b>3</b> Press the [ENT] key.</p> <p><b>4</b> Input LENGTH.</p> <p><b>5</b> Press the [ENT] key.</p> <p><b>6</b> Select TURN(direction of turn): RIGHT or LEFT.</p> <p><b>7</b> Press the [ENT] key.</p> <p><b>8</b> Select DIR(direction): IN(entrance) or OUT(exit).</p> <p><b>9</b> Press the [ENT] key.</p> | <p>[F3]</p> <p>Input<br/>RADIUS<br/>[ENT]</p> <p>Input<br/>LENGTH<br/>[ENT]</p> <p>Select<br/>[F1](LEFT)<br/>or<br/>[F2](RIGHT)<br/>[ENT]</p> <p>Select<br/>[F1](IN)<br/>or<br/>[F2](OUT)<br/>[ENT]</p> | <div style="border: 1px solid black; padding: 5px; margin-bottom: 5px;"> <b>F1:LINE</b><br/> <b>F2:CURVE</b><br/> <b>F3:SPIRAL</b><br/> <b>F4:POINT</b> </div> <div style="border: 1px solid black; padding: 5px; margin-bottom: 5px;"> <b>SPIRAL</b> 03<br/> <b>R &gt;</b> 0.000 m<br/> <b>L :</b> 0.000 m<br/> <b>INPUT --- -- ENTER</b> </div> <div style="border: 1px solid black; padding: 5px; margin-bottom: 5px;"> <b>SPIRAL</b> 03<br/> <b>R :</b> 100.000 m<br/> <b>L &gt;</b> 0.000 m<br/> <b>INPUT --- -- ENTER</b> </div> <div style="border: 1px solid black; padding: 5px; margin-bottom: 5px;"> <b>SPIRAL</b> 03<br/> <b>TURN &gt; RIGHT</b><br/> <b>DIR : IN</b><br/> <b>LEFT RIGHT --- ENTER</b> </div> <div style="border: 1px solid black; padding: 5px; margin-bottom: 5px;"> <b>SPIRAL</b> 03<br/> <b>TURN : LEFT</b><br/> <b>DIR &gt; IN</b><br/> <b>IN OUT --- ENTER</b> </div> <div style="border: 1px solid black; padding: 5px; text-align: center;"> <b>&lt;SET!&gt;</b> </div> |
| *1) SPIRAL cannot be input as the first data.                                                                                                                                                                                                                                                                                                                                                                  |                                                                                                                                                                                                         |                                                                                                                                                                                                                                                                                                                                                                                                                                                                                                                                                                                                                                                                                                                                                                                                                                                                                                                                                                                                             |



### 6.6.3 Search Data

To search for input data, carry out the following operating procedure.

| Operating procedure                                                                                              | Operation                      | Display                                                                               |
|------------------------------------------------------------------------------------------------------------------|--------------------------------|---------------------------------------------------------------------------------------|
| <b>1</b> After pressing the [MENU] key, press the [F4](P↓), [F1], [F4] key to get the programs menu on page 2/2. | [MENU]<br>[F4]<br>[F1]<br>[F4] | <b>PROGRAMS</b> 2/2<br><b>F1:AREA</b><br><b>F2:POINT TO LINE</b><br><b>F3:ROAD</b> P↓ |
| <b>2</b> Press the [F3], [F1], [F2], [F2] key.<br>(Refer to "Search data" on page 6-22.)                         | [F3]<br>[F1]<br>[F2]<br>[F2]   | <b>DATA SEARCH</b><br><b>F1:FIRST DATA</b><br><b>F2:LAST DATA</b>                     |
| <b>3</b> To search from the first data, select [F1] (FIRST DATA).                                                | [F1]                           | <b>LINE</b> 01/30<br><b>L :</b> 100.000 m<br><b>AZ:</b> 45°00'00"<br><b>EDIT</b> ↓    |
| <b>4</b> To switch to different data, press the [↓] or [↑] key.                                                  | [↓] or [↑]                     | ⋮                                                                                     |
|                                                                                                                  |                                | <b>SPIRAL</b> 30/30<br><b>R :</b> 200.000 m<br><b>L :</b> 100.000 m<br><b>EDIT</b> ↓  |

### 6.6.4 Edit Data

To edit input data, carry out the following operating procedure.

| Operating procedure                          | Operation | Display                                                                                         |
|----------------------------------------------|-----------|-------------------------------------------------------------------------------------------------|
| <b>1</b> In DATA SEARCH, press the [F1] key. | [F1]      | <b>LINE</b> 01/30<br><b>L :</b> 100.000 m<br><b>AZ:</b> 45°00'00"<br><b>EDIT</b> ↓              |
| <b>2</b> Edit the data.                      | Edit data | <b>LINE</b> 01<br><b>L &gt;</b> 100.000 m<br><b>AZ:</b> 45°00'00"<br><b>INPUT</b> --- --- ENTER |

### 6.6.5 Set OCC and BS

To set the Occupied Point and Backsight Point, carry out the following operating procedure.

| Operating procedure                                                                                                                                                                                                                                                                    | Operation                                | Display                                                                                      |
|----------------------------------------------------------------------------------------------------------------------------------------------------------------------------------------------------------------------------------------------------------------------------------------|------------------------------------------|----------------------------------------------------------------------------------------------|
| <p><b>1</b> After pressing the [MENU] key, press the [F4](P↓), [F1], [F4]key to get the programs menu on page 2/2.</p>                                                                                                                                                                 | <p>[MENU]<br/>[F4]<br/>[F1]<br/>[F4]</p> | <pre>PROGRAMS          2/2 F1:AREA F2:POINT TO LINE F3:ROAD          P↓</pre>                |
| <p><b>2</b> Press the [F3], [F2], [F1] key.<br/>(Refer to "Set OCC and BS" on page 6-22.)</p>                                                                                                                                                                                          | <p>[F3]<br/>[F2]<br/>[F1]</p>            | <pre>OCC&amp;BS F1:OCC&amp;BS F2:RESECTION</pre>                                             |
| <p><b>3</b> Press the [F1] key. *1)</p>                                                                                                                                                                                                                                                | <p>[F1]</p>                              | <pre>OCC&amp;BS F1:COORD. DATA F2:ROAD DATA</pre>                                            |
| <p><b>4</b> To input OCC. PT, press the [F1](COORD. DATA)or [F2](ROAD DATA) key.</p> <p>COORD. DATA:<br/>Choose the data from Coord Data and set the Occupied Point.</p> <p>ROAD DATA:<br/>Create the data from Road Data and set the Occupied Point.</p> <p>(Example : ROAD DATA)</p> | <p>[F2]</p>                              | <pre>OCC. PT CHAIN:1000.000  INPUT ---  --- ENTER</pre>                                      |
| <p><b>5</b> Input OCC. PT, press the [ENT] key.</p>                                                                                                                                                                                                                                    | <p>Input<br/>OCC. PT<br/><br/>[ENT]</p>  | <pre>CHAIN:1000.000 &gt;CENTER  LEFT RIGHT --- ENTER</pre>                                   |
| <p><b>6</b> Press the [ENT] key.</p> <p>LEFT or RIGHT: Use the offset point.<br/>CENTER: Use the center point.</p> <p>(Example : CENTER)</p>                                                                                                                                           | <p>[ENT]</p>                             | <pre>CHAIN:1000.000 N :          0.000 m E :          0.000 m &gt;OK ?      [YES] [NO]</pre> |
| <p><b>7</b> Press the [F3](YES) key.</p>                                                                                                                                                                                                                                               | <p>[F3]</p>                              | <pre>BACKSIGHT CHAIN:  INPUT ---  --- ENTER</pre>                                            |
| <p><b>8</b> Input the backsight.</p>                                                                                                                                                                                                                                                   | <p>Input<br/>Backsight</p>               |                                                                                              |
| <p><b>9</b> Press the [ENT] key.</p>                                                                                                                                                                                                                                                   | <p>[ENT]</p>                             | <pre>CHAIN: 0.000 &gt;CENTER  LEFT RIGHT --- ENTER</pre>                                     |



### 6.6.6 Setout Road

To setout the road, carry out the following operating procedure.

| Operating procedure                                                                                                                                                                                                                                      | Operation                      | Display                                                                                      |
|----------------------------------------------------------------------------------------------------------------------------------------------------------------------------------------------------------------------------------------------------------|--------------------------------|----------------------------------------------------------------------------------------------|
| 1 After pressing the [MENU] key, press the [F4](P↓), [F1], [F4] key to get the programs menu on page 2/2.                                                                                                                                                | [MENU]<br>[F4]<br>[F1]<br>[F4] | <b>PROGRAMS</b> 2/2<br><b>F1:AREA</b><br><b>F2:POINT TO LINE</b><br><b>F3:ROAD</b> P↓        |
| 2 Press the [F3], [F2], [F2] key.<br>(Refer to "Set out road" on page 6-22.)                                                                                                                                                                             | [F3]<br>[F2]<br>[F2]           | <b>SETOUT ROAD</b><br><b>CHAIN:1000.000</b><br><b>INPUT LIST --- ENTER</b>                   |
| 3 Input data.                                                                                                                                                                                                                                            | Input<br>data                  | <b>SETOUT ROAD</b><br><b>CHAIN:1200</b><br><b>INPUT --- --- ENTER</b>                        |
| 4 Press the [ENT] key.                                                                                                                                                                                                                                   | [ENT]                          | <b>CHAIN:1200</b><br><b>&gt; CENTER</b><br><b>LEFT RIGHT --- ENTER</b>                       |
| 5 Select offset.<br>(Example: RIGHT)<br>Press the [F2] key. *1)                                                                                                                                                                                          | [F2]                           | <b>CHAIN:1200</b><br><b>: RIGHT</b><br><b>=</b> m<br><b>--- --- [CLR] [ENT]</b>              |
| 6 Input the offset value.                                                                                                                                                                                                                                | Input<br>offset value          |                                                                                              |
| 7 Press the [ENT] key.<br><br>The setout point coordinates are displayed.                                                                                                                                                                                | [ENT]                          | <b>CHAIN:1200</b><br><b>N : 0.000 m</b><br><b>E : 0.000 m</b><br><b>&gt;OK ? [YES] [NO]</b>  |
| 8 Press the [F3](YES) key.<br>The distance to the setout point and the backsight are displayed.<br><br>HR: Calculated horizontal angle of the layout point<br>HD: Calculated horizontal distance from the instrument to the layout point                 | [F3]                           | <b>CALCULATED</b><br><b>HR= 60°00'00"</b><br><b>HD= 100.000 m</b><br><b>ANG DIST --- ---</b> |
| 9 Press the [F1](ANG) key.<br>CHAIN: Layout point<br>HR: Measured (Actual) horizontal angle.<br>dHR: Horizontal angle to be turned to the layout point = Actual horizontal angle - Calculated horizontal angle.<br>Correct direction when dHR = 0°00'00" | [F1]                           | <b>CHAIN:1200</b><br><b>HR: 60°00'00"</b><br><b>dHR: 0°00'00"</b><br><b>DIST --- NEZ ---</b> |
| 10 Press the [F1](DIST) key.<br>HD: Measuring (Actual) horizontal distance<br>dHD: Horizontal distance to be turned to the layout point = Actual horizontal distance – Calculated horizontal distance.                                                   | [F1]                           | <b>HD* 100.000 m</b><br><b>dHD: 0.000 m</b><br><b>MODE ANG NEZ NEXT</b>                      |

|                                                                     |                     |                                                                                                                                                                                                          |            |                 |            |                 |             |                     |
|---------------------------------------------------------------------|---------------------|----------------------------------------------------------------------------------------------------------------------------------------------------------------------------------------------------------|------------|-----------------|------------|-----------------|-------------|---------------------|
| <b>11</b> Press the [F3](NEZ) key.<br>The coordinate data is shown. | [F3]                | <table border="1"> <tr> <td><b>N *</b></td> <td><b>70.000 m</b></td> </tr> <tr> <td><b>E :</b></td> <td><b>50.000 m</b></td> </tr> <tr> <td><b>MODE</b></td> <td><b>ANG --- NEXT</b></td> </tr> </table> | <b>N *</b> | <b>70.000 m</b> | <b>E :</b> | <b>50.000 m</b> | <b>MODE</b> | <b>ANG --- NEXT</b> |
| <b>N *</b>                                                          | <b>70.000 m</b>     |                                                                                                                                                                                                          |            |                 |            |                 |             |                     |
| <b>E :</b>                                                          | <b>50.000 m</b>     |                                                                                                                                                                                                          |            |                 |            |                 |             |                     |
| <b>MODE</b>                                                         | <b>ANG --- NEXT</b> |                                                                                                                                                                                                          |            |                 |            |                 |             |                     |
| <b>12</b> Press the [F4](NEXT) key to set next layout point.        | [F4]                |                                                                                                                                                                                                          |            |                 |            |                 |             |                     |
| *1) If not selecting offset, press the [ENT] key.                   |                     |                                                                                                                                                                                                          |            |                 |            |                 |             |                     |

### 6.6.7 Select a File

To set the coordinates to be used for the Occupied Point and Backsight Point, carry out the following operating procedure.

| Operating procedure                                                                                              | Operation                      | Display                                                                                                                                                                                                                                        |                      |                      |                             |                         |                         |  |                |           |
|------------------------------------------------------------------------------------------------------------------|--------------------------------|------------------------------------------------------------------------------------------------------------------------------------------------------------------------------------------------------------------------------------------------|----------------------|----------------------|-----------------------------|-------------------------|-------------------------|--|----------------|-----------|
| <b>1</b> After pressing the [MENU] key, press the [F4](P↓), [F1], [F4] key to get the programs menu on page 2/2. | [MENU]<br>[F4]<br>[F1]<br>[F4] | <table border="1"> <tr> <td><b>PROGRAMS</b></td> <td><b>2 / 2</b></td> </tr> <tr> <td><b>F1:AREA</b></td> <td></td> </tr> <tr> <td><b>F2:POINT TO LINE</b></td> <td></td> </tr> <tr> <td><b>F3:ROAD</b></td> <td><b>P↓</b></td> </tr> </table> | <b>PROGRAMS</b>      | <b>2 / 2</b>         | <b>F1:AREA</b>              |                         | <b>F2:POINT TO LINE</b> |  | <b>F3:ROAD</b> | <b>P↓</b> |
| <b>PROGRAMS</b>                                                                                                  | <b>2 / 2</b>                   |                                                                                                                                                                                                                                                |                      |                      |                             |                         |                         |  |                |           |
| <b>F1:AREA</b>                                                                                                   |                                |                                                                                                                                                                                                                                                |                      |                      |                             |                         |                         |  |                |           |
| <b>F2:POINT TO LINE</b>                                                                                          |                                |                                                                                                                                                                                                                                                |                      |                      |                             |                         |                         |  |                |           |
| <b>F3:ROAD</b>                                                                                                   | <b>P↓</b>                      |                                                                                                                                                                                                                                                |                      |                      |                             |                         |                         |  |                |           |
| <b>2</b> Press the [F3], [F2] key.<br>(Refer to "Select a file" on page 6-22.)                                   | [F3]<br>[F2]                   | <table border="1"> <tr> <td><b>SETOUT</b></td> </tr> <tr> <td><b>F1:OCC&amp;BS</b></td> </tr> <tr> <td><b>F2:SETOUT ROAD</b></td> </tr> <tr> <td><b>F3:SELECT A FILE</b></td> </tr> </table>                                                   | <b>SETOUT</b>        | <b>F1:OCC&amp;BS</b> | <b>F2:SETOUT ROAD</b>       | <b>F3:SELECT A FILE</b> |                         |  |                |           |
| <b>SETOUT</b>                                                                                                    |                                |                                                                                                                                                                                                                                                |                      |                      |                             |                         |                         |  |                |           |
| <b>F1:OCC&amp;BS</b>                                                                                             |                                |                                                                                                                                                                                                                                                |                      |                      |                             |                         |                         |  |                |           |
| <b>F2:SETOUT ROAD</b>                                                                                            |                                |                                                                                                                                                                                                                                                |                      |                      |                             |                         |                         |  |                |           |
| <b>F3:SELECT A FILE</b>                                                                                          |                                |                                                                                                                                                                                                                                                |                      |                      |                             |                         |                         |  |                |           |
| <b>3</b> Press the [F3] key.                                                                                     | [F3]                           | <table border="1"> <tr> <td><b>SELECT A FILE</b></td> </tr> <tr> <td><b>FN: _____</b></td> </tr> <tr> <td><b>INPUT LIST --- ENTER</b></td> </tr> </table>                                                                                      | <b>SELECT A FILE</b> | <b>FN: _____</b>     | <b>INPUT LIST --- ENTER</b> |                         |                         |  |                |           |
| <b>SELECT A FILE</b>                                                                                             |                                |                                                                                                                                                                                                                                                |                      |                      |                             |                         |                         |  |                |           |
| <b>FN: _____</b>                                                                                                 |                                |                                                                                                                                                                                                                                                |                      |                      |                             |                         |                         |  |                |           |
| <b>INPUT LIST --- ENTER</b>                                                                                      |                                |                                                                                                                                                                                                                                                |                      |                      |                             |                         |                         |  |                |           |
| <b>4</b> Enter the name of the file being used (or select it from the list).                                     | Select a file                  |                                                                                                                                                                                                                                                |                      |                      |                             |                         |                         |  |                |           |
| <b>5</b> Press the [ENT] key.                                                                                    | [ENT]                          |                                                                                                                                                                                                                                                |                      |                      |                             |                         |                         |  |                |           |

### 6.6.8 Initialize ROAD data

To initialize the data, carry out the following operating procedure.

| Operating procedure                                                                                                                             | Operation                      | Display                                                                                                                                                                                                                                        |                        |                        |                            |  |                         |  |                |           |
|-------------------------------------------------------------------------------------------------------------------------------------------------|--------------------------------|------------------------------------------------------------------------------------------------------------------------------------------------------------------------------------------------------------------------------------------------|------------------------|------------------------|----------------------------|--|-------------------------|--|----------------|-----------|
| <b>1</b> After pressing the [MENU] key, press the [F4](P↓), [F1], [F4] key to get the programs menu on page 2/2.                                | [MENU]<br>[F4]<br>[F1]<br>[F4] | <table border="1"> <tr> <td><b>PROGRAMS</b></td> <td><b>2 / 2</b></td> </tr> <tr> <td><b>F1:AREA</b></td> <td></td> </tr> <tr> <td><b>F2:POINT TO LINE</b></td> <td></td> </tr> <tr> <td><b>F3:ROAD</b></td> <td><b>P↓</b></td> </tr> </table> | <b>PROGRAMS</b>        | <b>2 / 2</b>           | <b>F1:AREA</b>             |  | <b>F2:POINT TO LINE</b> |  | <b>F3:ROAD</b> | <b>P↓</b> |
| <b>PROGRAMS</b>                                                                                                                                 | <b>2 / 2</b>                   |                                                                                                                                                                                                                                                |                        |                        |                            |  |                         |  |                |           |
| <b>F1:AREA</b>                                                                                                                                  |                                |                                                                                                                                                                                                                                                |                        |                        |                            |  |                         |  |                |           |
| <b>F2:POINT TO LINE</b>                                                                                                                         |                                |                                                                                                                                                                                                                                                |                        |                        |                            |  |                         |  |                |           |
| <b>F3:ROAD</b>                                                                                                                                  | <b>P↓</b>                      |                                                                                                                                                                                                                                                |                        |                        |                            |  |                         |  |                |           |
| <b>2</b> Press the [F3], [F3] key.<br>(Refer to "Initialize ROAD data" on page 6-22.)                                                           | [F3]<br>[F3]                   | <table border="1"> <tr> <td><b>INITIALIZE DATA</b></td> </tr> <tr> <td><b>ERASE ROAD DATA</b></td> </tr> <tr> <td><b>&gt;OK ? [NO] [YES]</b></td> </tr> </table>                                                                               | <b>INITIALIZE DATA</b> | <b>ERASE ROAD DATA</b> | <b>&gt;OK ? [NO] [YES]</b> |  |                         |  |                |           |
| <b>INITIALIZE DATA</b>                                                                                                                          |                                |                                                                                                                                                                                                                                                |                        |                        |                            |  |                         |  |                |           |
| <b>ERASE ROAD DATA</b>                                                                                                                          |                                |                                                                                                                                                                                                                                                |                        |                        |                            |  |                         |  |                |           |
| <b>&gt;OK ? [NO] [YES]</b>                                                                                                                      |                                |                                                                                                                                                                                                                                                |                        |                        |                            |  |                         |  |                |           |
| <b>3</b> When the [F4] (YES) key is pressed, all ROAD DATA with the exception of the coordinate data file is erased.<br><br>Press the [F4] key. | [F4]                           |                                                                                                                                                                                                                                                |                        |                        |                            |  |                         |  |                |           |

## 7 DATA COLLECTION

The GTS-230N series are able to store the measured data into the internal memory. The internal memory is shared by the measured data files and the coordinate data files. Maximum 30 files can be generated.

- **Measured data**

The collected data is memorized into a files.

- **The number of measurement points**

( In case not using the internal memory in layout mode)

|                    |
|--------------------|
| MAX. 24,000 points |
|--------------------|

Because the internal memory covers both data collection mode and layout mode, the number of measurement points will be decreased when the layout mode is used. For the internal memory, refer to Chapter 9 “MEMORY MANAGER MODE”.

- |                                                                                                                                                                                                                                                                                                                                                                                                  |
|--------------------------------------------------------------------------------------------------------------------------------------------------------------------------------------------------------------------------------------------------------------------------------------------------------------------------------------------------------------------------------------------------|
| <ol style="list-style-type: none"><li>1) When turning off the power, ensure that you are in the main menu screen or main angle measurement mode.<br/>This ensures completion of the memory access process and avoids possible damage to the stored data.</li><li>2) It is recommended for safety to charge the battery (BT-52QA) beforehand and prepare fully charged spare batteries.</li></ol> |
|--------------------------------------------------------------------------------------------------------------------------------------------------------------------------------------------------------------------------------------------------------------------------------------------------------------------------------------------------------------------------------------------------|



● Data collect menu operation

By pressing the [MENU] key, the instrument will be in MENU 1/3 mode.  
 Press the [F1](DATA COLLECT) key, the menu of data collect 1/2 will be shown.

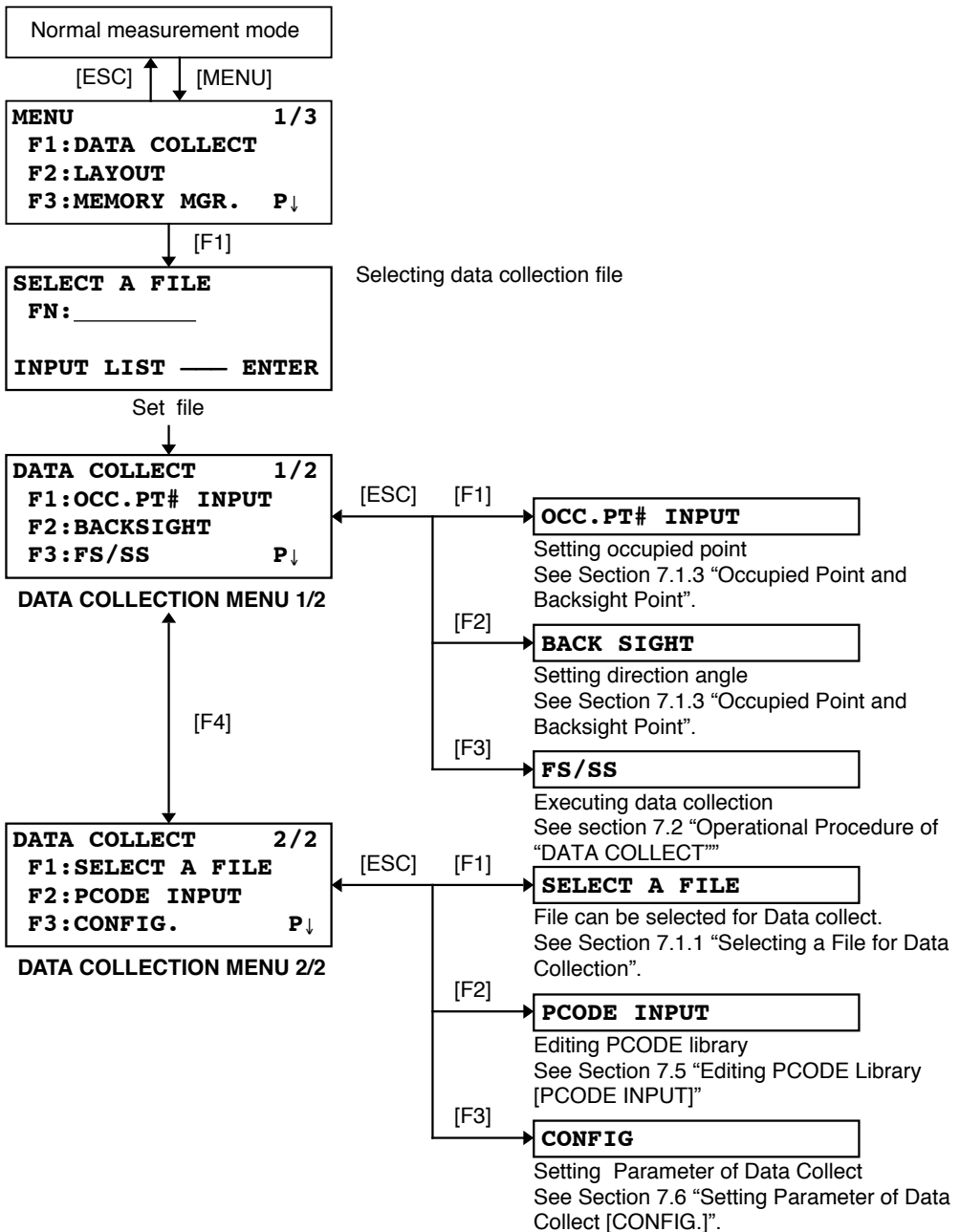

## 7.1 Preparation

### 7.1.1 Selecting a File for Data Collection

A file used by data collection mode must be selected at first.

Select a file before beginning data collection mode because selection screen of a file is displayed. And a selection from data collection menu is possible in the mode.

| Operating procedure                                                                                                                                                                                                                                                                                          | Operation                                                                           | Display                                                                                                    |                                                                                           |                                                                                     |
|--------------------------------------------------------------------------------------------------------------------------------------------------------------------------------------------------------------------------------------------------------------------------------------------------------------|-------------------------------------------------------------------------------------|------------------------------------------------------------------------------------------------------------|-------------------------------------------------------------------------------------------|-------------------------------------------------------------------------------------|
| 1 Press [F1](DATA COLLECT) key from menu 1/3.                                                                                                                                                                                                                                                                | [F1]                                                                                | <pre> MENU                               1/3 F1:DATA COLLECT F2:LAYOUT F3:MEMORY MGR.  P↓           </pre> |                                                                                           |                                                                                     |
| 2 Press [F2](LIST) key to display the list of file. *1)                                                                                                                                                                                                                                                      | [F2]                                                                                | <pre> SELECT A FILE FN: _____ INPUT LIST  —  ENTER           </pre>                                        |                                                                                           |                                                                                     |
| 3 Scroll file list by pressing [▼] or [▲] key and select a file to use. *2),3)                                                                                                                                                                                                                               | [▼] or [▲]                                                                          | <pre> AMIDATA      /M0123 →*HILDATA    /M0345 TOPDATA      /M0789 —  SRCH  —  ENTER           </pre>       |                                                                                           |                                                                                     |
| 4 Press [F4](ENTER) key.<br>The file will be set and data collect 1/2 menu will be shown.                                                                                                                                                                                                                    | [F4]                                                                                | <pre> TOPDATA      /M0789 →RAPDATA     /M0564 SATDATA      /M0456 —  SRCH  —  ENTER           </pre>       |                                                                                           |                                                                                     |
|                                                                                                                                                                                                                                                                                                              |                                                                                     | <pre> DATA COLLECT  1/2 F1:OCC.PT# INPUT F2:BACKSIGHT F3:FS/SS      P↓           </pre>                    |                                                                                           |                                                                                     |
| <p>*1) If you want to make a new file or input file name directly, press [F1](INPUT) key and enter a file name.<br/> *2) When a file has been selected already, '*' mark is indicated on left of current file name.<br/> *3) Data in a file shown with arrow can be searched by pressing [F2](SRCH) key.</p> |                                                                                     |                                                                                                            |                                                                                           |                                                                                     |
| <table border="1" style="width: 100%;"> <tr> <td style="padding: 5px;"> <pre> DATA COLLECT  2/2 F1:SELECT A FILE F2:PCODE INPUT F3:CONFIG.    P↓           </pre> </td> <td style="padding: 5px;"> <p>●It is possible to select a file from DATA COLLECT 2/2 menu in the same way.</p> </td> </tr> </table>  |                                                                                     |                                                                                                            | <pre> DATA COLLECT  2/2 F1:SELECT A FILE F2:PCODE INPUT F3:CONFIG.    P↓           </pre> | <p>●It is possible to select a file from DATA COLLECT 2/2 menu in the same way.</p> |
| <pre> DATA COLLECT  2/2 F1:SELECT A FILE F2:PCODE INPUT F3:CONFIG.    P↓           </pre>                                                                                                                                                                                                                    | <p>●It is possible to select a file from DATA COLLECT 2/2 menu in the same way.</p> |                                                                                                            |                                                                                           |                                                                                     |

### 7.1.2 Selecting a Coordinate File for Data Collection

When coordinate data in a coordinate data file are used for occupied point or backsight point, select a coordinate file from the data collect menu 2/2 beforehand.

| Operating procedure                                                                                           | Operation | Display                                                                           |
|---------------------------------------------------------------------------------------------------------------|-----------|-----------------------------------------------------------------------------------|
| <b>1</b> Press the [F1](SELECT A FILE) key from DATA COLLECT menu 2/2.                                        | [F1]      | <pre>DATA COLLECT    2/2 F1:SELECT A FILE F2:PCODE INPUT F3:CONFIG.      P↓</pre> |
| <b>2</b> Press the [F2](COORD.DATA) key.                                                                      | [F2]      | <pre>SELECT A FILE F1:MEAS.DATA F2:COORD.DATA</pre>                               |
| <b>3</b> Select a coordinate file in the same manner as Section 7.1.1 "Selecting a File for Data Collection". |           | <pre>SELECT A FILE FN:_____ INPUT LIST --- ENTER</pre>                            |

### 7.1.3 Occupied Point and Backsight Point

The occupied point and direction angle in the data collect mode are linked with the occupied point and direction angle in normal coordinate measurement.

It is possible to set or change the occupied point and direction angle from the data collect mode.

Occupied point can be set by two setting methods as follow.

- 1) Setting from the coordinate data stored in the internal memory.
- 2) Direct key input.

The following three setting methods for backsight point can be selected.

- 1) Setting from the coordinate data stored in the internal memory.
- 2) Direct key input of coordinate data.
- 3) Direct key input of setting angle.

Note: See 9.4 "Coordinate Data Direct Key Input" and 9.7.2 "Loading Data" for how to store coordinate into the internal memory.

● Example for setting the occupied point:

In case of setting occupied point from the coordinate data stored in the internal memory.

| Operating procedure                                                                                       | Operation | Display                                                                 |
|-----------------------------------------------------------------------------------------------------------|-----------|-------------------------------------------------------------------------|
| <b>1</b> Press the [F1](OCC.PT# INPUT) key from the data collect menu 1/2.<br>The previous data is shown. | [F1]      | <pre>PT#    →PT-01 ID     : INS.HT:  0.000 m INPUT SRCH REC OCNEZ</pre> |
| <b>2</b> Press the [F4] (OCNEZ) key.                                                                      | [F4]      | <pre>OCC.PT PT#:PT-01 INPUT LIST NEZ ENTER</pre>                        |
| <b>3</b> Press the [F1](INPUT) key.                                                                       | [F1]      | <pre>OCC.PT PT#=PT-01 [ALP] [SPC] [CLR] [ENT]</pre>                     |

|                                                                                                                                                                                                                                                                                                                                                                                                                                                    |                             |                                                                             |
|----------------------------------------------------------------------------------------------------------------------------------------------------------------------------------------------------------------------------------------------------------------------------------------------------------------------------------------------------------------------------------------------------------------------------------------------------|-----------------------------|-----------------------------------------------------------------------------|
| <p><b>4</b> Enter PT#, press [F4](ENT) key. *1)</p>                                                                                                                                                                                                                                                                                                                                                                                                | <p>Enter PT#<br/>[F4]</p>   | <pre>PT#    →PT-11 ID     : INS.HT:  0.000 m INPUT SRCH REC OCNEZ</pre>     |
| <p><b>5</b> Enter ID, INS.HT in the same way. *2),3)</p>                                                                                                                                                                                                                                                                                                                                                                                           | <p>Enter ID,<br/>INS.HT</p> | <pre>PT#    :PT-11 ID     : INS.HT→  1.335 m INPUT SRCH REC OCNEZ</pre>     |
| <p><b>6</b> Press [F3](REC) key.</p>                                                                                                                                                                                                                                                                                                                                                                                                               | <p>[F3]</p>                 | <pre>&gt;REC ?      [YES] [NO]</pre>                                        |
| <p><b>7</b> Press [F3](YES) key.<br/>The display returns to the data collect menu 1/2.</p>                                                                                                                                                                                                                                                                                                                                                         | <p>[F3]</p>                 | <pre>DATA COLLECT  1/2 F1:OCC.PT# INPUT F2:BACKSIGHT F3:FS/SS      P↓</pre> |
| <p>*1) Refer to Section 2.6 "How to Enter Alphanumeric characters".<br/> *2) ID can be input by inputting a register number linked with PCODE Library.<br/> To show the list of PCODE library, press the [F2](SRCH) key.<br/> *3) Press the [F3](REC) key when you do not input the INS.HT.<br/> ● The data recorded in data collect is PT#, ID and INS.HT.<br/> ● If point is not found in internal memory "PT# DOES NOT EXIST" is displayed.</p> |                             |                                                                             |

- Example for setting the direction angle:

The following is to memorize the data of the backsight after setting the backsight point from point number.

| Operating procedure                                                                                                                                                                                                                                                                                                                                                                                                                                                                                                                                                                          | Operation               | Display                                                                                                                                                                                              |
|----------------------------------------------------------------------------------------------------------------------------------------------------------------------------------------------------------------------------------------------------------------------------------------------------------------------------------------------------------------------------------------------------------------------------------------------------------------------------------------------------------------------------------------------------------------------------------------------|-------------------------|------------------------------------------------------------------------------------------------------------------------------------------------------------------------------------------------------|
| <b>1</b> Press the [F2](BACKSIGHT) key from the data collect menu 1/2.<br>The previous data is shown.                                                                                                                                                                                                                                                                                                                                                                                                                                                                                        | [F2]                    | <pre>BS#   → PCODE : R.HT  :   0.000 m INPUT OSET MEAS BS</pre>                                                                                                                                      |
| <b>2</b> Press the [F4] (BS) key. *1)                                                                                                                                                                                                                                                                                                                                                                                                                                                                                                                                                        | [F4]                    | <pre>BACKSIGHT PT# :  INPUT LIST NE/AZ ENT</pre>                                                                                                                                                     |
| <b>3</b> Press the [F1](INPUT) key.                                                                                                                                                                                                                                                                                                                                                                                                                                                                                                                                                          | [F1]                    | <pre>BACKSIGHT PT# =  [ALP] [SPC] [CLR] [ENT]</pre>                                                                                                                                                  |
| <b>4</b> Enter PT#, press the [F4](ENT) key. *2)<br><br>Enter PCODE,R.HT in the same way. *3),4)                                                                                                                                                                                                                                                                                                                                                                                                                                                                                             | Enter PT#<br>[F4]       | <pre>BS#   → PT-22 PCODE : R.HT  :   0.000 m INPUT OSET MEAS BS</pre>                                                                                                                                |
| <b>5</b> Press the [F3](MEAS) key.                                                                                                                                                                                                                                                                                                                                                                                                                                                                                                                                                           | [F3]                    | <pre>BS#   → PT-22 PCODE : R.HT  :   0.000 m *VH   SD  NEZ  ———</pre>                                                                                                                                |
| <b>6</b> Collimate back sight point.<br>Select one of the measuring mode and press the soft key.<br>EXAMPLE : [F2](Slope Distance) key.<br>Measuring starts.<br>Horizontal circle is set to calculated direction angle.<br>Measuring result is memorized and the display returns to the data collect menu 1/2.                                                                                                                                                                                                                                                                               | Collimate<br>BS<br>[F2] | <pre>V :   90°00'00" HR:   0°00'00" SD*[n] &lt;&lt;&lt; m &gt; Measuring...</pre> <p style="text-align: center;">↓</p> <pre>DATA COLLECT   1/2 F1:OCC.PT# INPUT F2:BACKSIGHT F3:FS/SS       P↓</pre> |
| <p>*1) Pressing each time the [F3] key, the input method changes as Coordinate value, Angle, Coordinate point name alternatively.</p> <p>*2) Refer to Chapter 2.6 "How to Enter Alphanumeric characters".</p> <p>*3) PCODE can be input by inputting a register number linked with PCODE Library.<br/>To show the list of PCODE library, press the [F2](SRCH) key.</p> <p>*4) Data collect sequence can be set to [EDIT→MEAS]. Refer to Section 7.6 "Setting Parameter of Data Collect [CONFIG.]".</p> <p>● If point is not found in internal memory " PT# DOES NOT EXIST" is displayed.</p> |                         |                                                                                                                                                                                                      |

## 7.2 Operational Procedure of “DATA COLLECT”

| Operating procedure                                                                                                                                                                                                                 | Operation                                                            | Display                                                                                                                                                                                                     |
|-------------------------------------------------------------------------------------------------------------------------------------------------------------------------------------------------------------------------------------|----------------------------------------------------------------------|-------------------------------------------------------------------------------------------------------------------------------------------------------------------------------------------------------------|
| <p><b>1</b> Press the [F3](FS/SS) key from the data collect menu 1/2.<br/>The previous data is shown.</p>                                                                                                                           | [F3]                                                                 | <pre>DATA COLLECT      1/2 F1:OCC.PT# INPUT F2:BACKSIGHT F3:FS/SS          P↓</pre>                                                                                                                         |
| <p><b>2</b> Press the [F1](INPUT) key and enter PT#. Press the [F4](ENT) key. *1)</p>                                                                                                                                               | [F1]<br>Enter PT#<br>[F4]                                            | <pre>PT#   → PCODE : R.HT  :   0.000 m INPUT SRCH MEAS ALL</pre>                                                                                                                                            |
| <p><b>3</b> Enter PCODE, R.HT in the same way. *2),3)</p>                                                                                                                                                                           | [F1]<br>Enter<br>PCODE<br>[F4]                                       | <pre>PT#   =PT-01 PCODE : R.HT  :   0.000 m [ALP] [SPC] [CLR] [ENT]</pre>                                                                                                                                   |
| <p><b>4</b> Press the [F3](MEAS) key.</p> <p><b>5</b> Collimate the target point.</p>                                                                                                                                               | [F1]<br>Enter<br>PCODE<br>[F4]<br>[F1]<br>Enter R.HT<br>[F4]<br>[F3] | <pre>PT#   →PT-01 PCODE :TOPCON R.HT  :   1.200 m INPUT SRCH MEAS ALL VH *SD  NEZ OFFSET</pre>                                                                                                              |
| <p><b>6</b> Press one of the [F1] to [F3] key. *4)<br/>Example: [F2](SD) key.<br/>Measuring starts.</p> <p>The measuring data is memorized and the display changes to the next point. *5)<br/>PT# is automatically incremented.</p> | [F2]                                                                 | <pre>V : 90°10'20" HR: 120°30'40" SD*[n] &lt; m &gt; Measuring... &lt; complete &gt;</pre> <p style="text-align: center;">↓</p> <pre>PT#   →PT-02 PCODE :TOPCON R.HT  :   1.200 m INPUT SRCH MEAS ALL</pre> |
| <p><b>7</b> Enter the next point data and collimate the next point.</p> <p><b>8</b> Press [F4](ALL) key.<br/>Measuring starts in the same measuring mode of the previous point.<br/>Data is recorded.</p>                           | Collimate<br><br>[F4]                                                | <pre>V : 90°10'20" HR: 120°30'40" SD*[n] &lt; m &gt; Measuring... &lt; complete &gt;</pre> <p style="text-align: center;">↓</p> <pre>PT#   →PT-03 PCODE :TOPCON R.HT  :   1.200 m INPUT SRCH MEAS ALL</pre> |
| <p>Continue the measuring in the same way.<br/>To finish the mode , press [ESC] key.</p>                                                                                                                                            |                                                                      |                                                                                                                                                                                                             |

- \*1) Refer to Section 2.6 "How to Enter Alphanumeric characters".
- \*2) PCODE can be input by inputting a register number linked with PCODE Library.  
To show the list of PCODE library, press the [F2](SRCH) key.
- \*3) Data collect sequence can be set to [EDIT→MEAS]. See to Section 7.6 "Setting Parameter of Data Collect [CONFIG.]".
- \*4) The mark "\*" indicates the previous measuring mode.
- \*5) You can confirm the measured data as follows. Refer to Section 7.6 "Setting Parameter of Data Collect [CONFIG.]".

```
V : 90°10'20"
HR: 120°30'40"
SD: 98.765 m
> OK ? [YES] [NO]
```

### ● Searching the recorded data

While executing the DATA COLLECT mode, you can search the recorded data.

| Operating procedure                                                                                                                                                                                                                                       | Operation                       | Display                                                                                                                   |
|-----------------------------------------------------------------------------------------------------------------------------------------------------------------------------------------------------------------------------------------------------------|---------------------------------|---------------------------------------------------------------------------------------------------------------------------|
| <p><b>1</b> While executing the DATA COLLECT mode, press [F2](SRCH) key. *1)</p> <p>The using file name will appear on the top of the right side of the display.</p> <p><b>2</b> Select one of three search methods by pressing [F1] to [F3] key. *2)</p> | <p>[F2]</p> <p>[F1] to [F3]</p> | <pre>PT# → PT-02 PCODE : R.HT : 1.200 m INPUT SRCH MEAS ALL  SEARCH [TOPCON] F1:FIRST DATA F2:LAST DATA F3:PT# DATA</pre> |
| <p>*1) It is possible to see the PCODE list when the arrow is located beside PCODE or ID.</p> <p>*2) The operation is same as the "SEARCH" in the MEMORY MANAGER mode.<br/>For more information, refer to Section 9.2 "Searching Data".</p>               |                                 |                                                                                                                           |

## ● Entering PCODE / ID using PCODE Library

While executing the DATA COLLECT mode, you can enter PCODE /ID from PCODE Library.

| Operating procedure                                                                                                                                                                                                                                                                 | Operation        | Display                                                                                          |
|-------------------------------------------------------------------------------------------------------------------------------------------------------------------------------------------------------------------------------------------------------------------------------------|------------------|--------------------------------------------------------------------------------------------------|
| <ol style="list-style-type: none"> <li>1 Move the arrow to the PCODE or ID in the DATA COLLECT mode, press the [F1](INPUT) key.</li> <li>2 Enter a register number linked with PCODE library and press the [F4](ENT) key.<br/>(Example)<br/>Register number, 32 = TOPCON</li> </ol> | [F1]             | <b>PT# :PT-02</b><br><b>PCODE →</b><br><b>R.HT : 1.200 m</b><br><b>INPUT SRCH MEAS ALL</b>       |
|                                                                                                                                                                                                                                                                                     | Enter No<br>[F4] | <b>PT# :PT-02</b><br><b>PCODE =32</b><br><b>R.HT : 1.200 m</b><br><b>[ALP] [SPC] [CLR] [ENT]</b> |
|                                                                                                                                                                                                                                                                                     |                  | <b>PT# :PT-02</b><br><b>PCODE :TOPCON</b><br><b>R.HT → 1.200 m</b><br><b>INPUT SRCH MEAS ALL</b> |

## ● Entering PCODE / ID from the list of PCODE

You can also enter PCODE / ID from the list of PCODE.

| Operating procedure                                                                                                                                                                                                                                                                                                                                                          | Operation            | Display                                                                                          |
|------------------------------------------------------------------------------------------------------------------------------------------------------------------------------------------------------------------------------------------------------------------------------------------------------------------------------------------------------------------------------|----------------------|--------------------------------------------------------------------------------------------------|
| <ol style="list-style-type: none"> <li>1 Move the arrow to the PCODE or ID in the DATA COLLECT mode, press the [F2](SRCH) key.</li> <li>2 By pressing the following keys, the register number will increase or decrease.<br/>[▲]or[▼]:Increasing or Decreasing one by one<br/>[▶]or[◀]:By ten Increasing or Decreasing. *1)</li> <li>3 Press the [F4](ENTER) key.</li> </ol> | [F2]                 | <b>PT# :PT-02</b><br><b>PCODE →</b><br><b>R.HT : 1.200 m</b><br><b>INPUT SRCH MEAS ALL</b>       |
|                                                                                                                                                                                                                                                                                                                                                                              | [▲]or[▼]<br>[▶]or[◀] | <b>→ 001:PCODE01</b><br><b>002:PCODE02</b><br><b>EDIT — CLR ENTER</b>                            |
|                                                                                                                                                                                                                                                                                                                                                                              |                      | <b>031:PCODE31</b><br><b>→ 032:TOPCON</b><br><b>033:HILTOP</b><br><b>EDIT — CLR ENTER</b>        |
|                                                                                                                                                                                                                                                                                                                                                                              | [F4]                 | <b>PT# :PT-02</b><br><b>PCODE :TOPCON</b><br><b>R.HT → 1.200 m</b><br><b>INPUT SRCH MEAS ALL</b> |
| <p>*1) To edit the PCODE library, press the [F1](EDIT) key.<br/>To delete the PCODE registered with shown an arrow, press the [F3](CLR) key.<br/>PCODE can be edited in DATA COLLECT menu 2/2 or MEMORY MANAGER menu 2/3.</p>                                                                                                                                                |                      |                                                                                                  |



## 7.3 Data Collect Offset Measurement mode

This mode is useful when it is difficult to set up the prism directly, for example at the center of a tree. Data Collect . Offset Measurement has four measuring methods.

- Angle offset measurement
- Distance offset measurement
- Plane offset measurement
- Column offset measurement

### 7.3.1 Angle Offset Measurement

Place the prism at the same horizontal distance from the instrument as that of point A0 to measure.

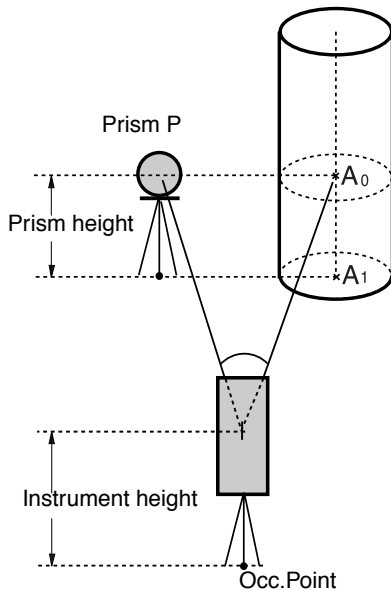







When measuring coordinates of ground point A1 :Set the instrument height / prism height.

When measuring coordinates of point A0 : Set the instrument height only. (Set the prism height to 0 ).

When sighting to A<sub>0</sub>, you can select one of two ways. One is to fix vertical angle to the prism position even up down the telescope position, and the other is to gear vertical angle to the up down of telescope movement. In case following the vertical angle to the movement of telescope, SD (Slope Distance) and VD (Vertical Distance) will be changed according to the movement of telescope.

To set this option, refer to Chapter 16 "SELECTING MODE".

| Operating procedure                                        | Operation   | Display                                                                                       |
|------------------------------------------------------------|-------------|-----------------------------------------------------------------------------------------------|
| 1 Press the [F3](MEAS) key.                                | [F3]        | <pre>PT#   →PT-11 PCODE :TOPCON R.HT  :   1.200 m INPUT SRCH MEAS ALL VH *SD  NEZ OFSET</pre> |
| 2 Press the [F4](OFSET) key.                               | [F4]        | <pre>OFFSET                1/2 F1:ANG. OFFSET F2:DIST. OFFSET F3:PLANE OFFSET P↓</pre>        |
| 3 Press the [F1] key.                                      | [F1]        | <pre>OFFSET-MEASUREMENT HR: 120°30'40" HD:                m &gt;Sight ?   [YES][NO]</pre>     |
| 4 Collimate the prism.                                     | Collimate P |                                                                                               |
| 5 Press the [F3](YES) key.<br>Continuous measuring starts. | [F3]        | <pre>OFFSET-MEASUREMENT HR: 120°30'40" HD*[n]          &lt; m &gt;measuring ...</pre>         |

|                                                                                                                                                                                                                         |                                                                                       |                                                                                                                                                      |
|-------------------------------------------------------------------------------------------------------------------------------------------------------------------------------------------------------------------------|---------------------------------------------------------------------------------------|------------------------------------------------------------------------------------------------------------------------------------------------------|
| <p><b>6</b> Collimate point A0 using the horizontal motion clamp and horizontal tangent screw.</p>                                                                                                                      | Collimate A0                                                                          | <pre> <b>OFFSET-MEASUREMENT</b>   HR: 120°30'40"   SD*   12.345 m   &gt;OK?   [ YES ] [ NO ]           </pre>                                        |
| <p><b>7</b> Show the horizontal distance of point A0.</p>                                                                                                                                                               | [  ] | <pre> <b>OFFSET-MEASUREMENT</b>   HR: 123°30'40"   SD:   12.345 m   &gt;OK?   [ YES ] [ NO ]           </pre>                                        |
| <p><b>8</b> Show the relative elevation of point A0.</p>                                                                                                                                                                | [  ] | <pre> <b>OFFSET-MEASUREMENT</b>   HR: 123°30'40"   HD:   6.543 m   &gt;OK?   [ YES ] [ NO ]           </pre>                                         |
| <p>● Each time pressing [  ] key, horizontal distance , relative elevation and slope distance are shown in sequence.</p>               | [  ] | <pre> <b>OFFSET-MEASUREMENT</b>   HR: 123°30'40"   VD:   0.843 m   &gt;OK?   [ YES ] [ NO ]           </pre>                                         |
| <p><b>9</b> Show N coordinate of point A0 or A1.</p> <p>● Each time pressing [  ] key, N,E and Z coordinate are shown in sequence.</p> | [  ] | <pre> <b>OFFSET-MEASUREMENT</b>   HR: 123°30'40"   N :   -12.345 m   &gt;OK?   [ YES ] [ NO ]           </pre>                                       |
| <p><b>10</b> Press the [F3](YES) key.</p> <p>The data is recorded and the next measuring point is displayed.</p>                                                                                                        | [F3]                                                                                  | <pre> <b>PT#</b>    → <b>PT-12</b> <b>PCODE</b>  : <b>TOPCON</b> <b>R.HT</b>   :   <b>1.200 m</b> <b>INPUT</b> <b>SRCH MEAS ALL</b>           </pre> |

### 7.3.2 Distance Offset Measurement

The measurement of a place apart from a prism is possible by inputting offset horizontal distance of front and back / right and left.

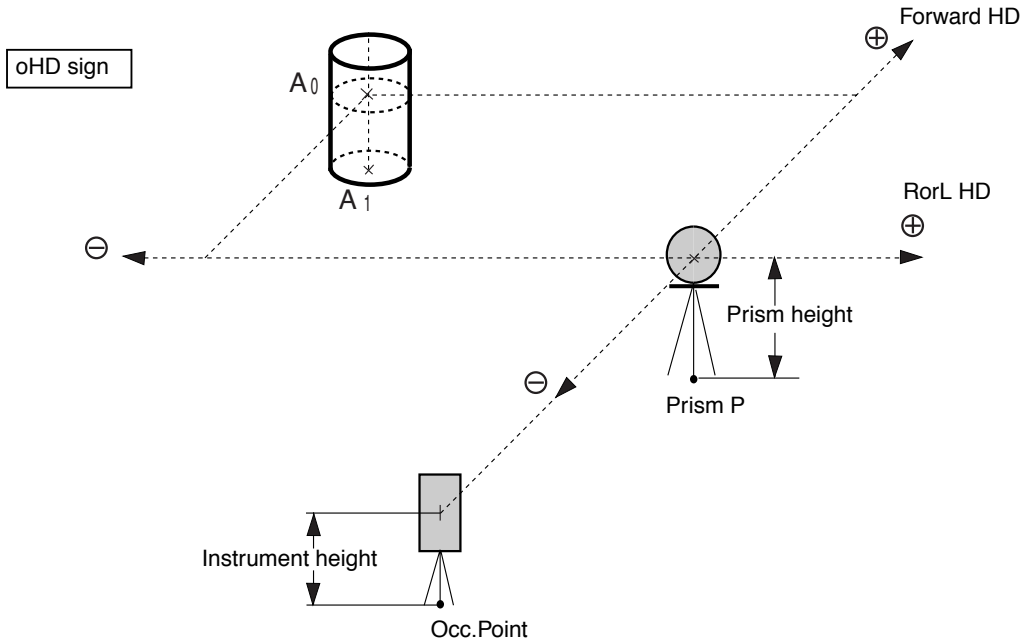

When measuring coordinates of ground point A<sub>1</sub>: Set the instrument height / prism height.

When measuring coordinates of point A<sub>0</sub>: Set the instrument height only.  
(Set the prism height to 0).

| Operating procedure                                                             | Operation                | Display                                                                                    |
|---------------------------------------------------------------------------------|--------------------------|--------------------------------------------------------------------------------------------|
| 1 Press the [F3](MEAS) key.                                                     | [F3]                     | <pre>PT#   →PT-11 PCODE :TOPCON R.HT  : 1.200 m INPUT SRCH MEAS ALL VH *SD NEZ OFSET</pre> |
| 2 Press the [F4](OFSET) key.                                                    | [F4]                     | <pre>OFFSET          1/2 F1:ANG. OFFSET F2:DIST. OFFSET F3:PLANE OFFSET P↓</pre>           |
| 3 Press the [F2] key.                                                           | [F2]                     | <pre>DISTANCE OFFSET INPUT RorL HD oHD: 0.000 m INPUT — SKP ENTER</pre>                    |
| 4 Press the [F1](INPUT) key and enter Right and Left direction offset value.*1) | [F1]<br>Enter HD<br>[F4] | <pre>DISTANCE OFFSET INPUT FORWARD HD oHD: 0.000 m INPUT — SKP ENTER</pre>                 |
| 5 Press the [F1](INPUT) key and enter Forward direction offset value. *1)       | [F1]<br>Enter HD<br>[F4] | <pre>PT#   :PT-11 PCODE : TOPCON R.HT  : 1.200 m — *SD NEZ —</pre>                         |

|                                                                                                                                                                                                         |                                |                                                                                                                                                                                                                                                                                                                                                                                                                                                                                        |
|---------------------------------------------------------------------------------------------------------------------------------------------------------------------------------------------------------|--------------------------------|----------------------------------------------------------------------------------------------------------------------------------------------------------------------------------------------------------------------------------------------------------------------------------------------------------------------------------------------------------------------------------------------------------------------------------------------------------------------------------------|
| <p><b>6</b> Collimate the prism.</p> <p><b>7</b> Press the [F2] or [F3] key.<br/>Example:[F3](NEZ) key<br/>Measuring starts.</p> <p>The data is recorded and the next measuring point is displayed.</p> | <p>Collimate P</p> <p>[F3]</p> | <div style="border: 1px solid black; padding: 5px;"> <p><b>N*[n]            &lt;&lt;&lt; m</b></p> <p><b>E :                    m</b></p> <p><b>Z :                    m</b></p> <p><b>&gt;measuring ...</b></p> <p><b>&gt;Calculating...</b></p> </div> <p style="text-align: center;">↓</p> <div style="border: 1px solid black; padding: 5px;"> <p><b>PT#     → PT-12</b></p> <p><b>PCODE : TOPCON</b></p> <p><b>R.HT    : 1.200 m</b></p> <p><b>INPUT SRCH MEAS ALL</b></p> </div> |
| <p>*1) To skip entering, press the [F3](SKP) key.</p>                                                                                                                                                   |                                |                                                                                                                                                                                                                                                                                                                                                                                                                                                                                        |

### 7.3.3 Plane Offset Measurement

Measuring will be taken for the place where direct measuring can not be done, for example distance or coordinate measuring for an edge of a plane.

Three random points (P1, P2, P3) on a plane will be measured at first in the plane offset measurement to determine the measured plane. Collimate the measuring point (P0) then the instrument calculates and displays coordinate and distance value of cross point between collimation axis and of the plane..

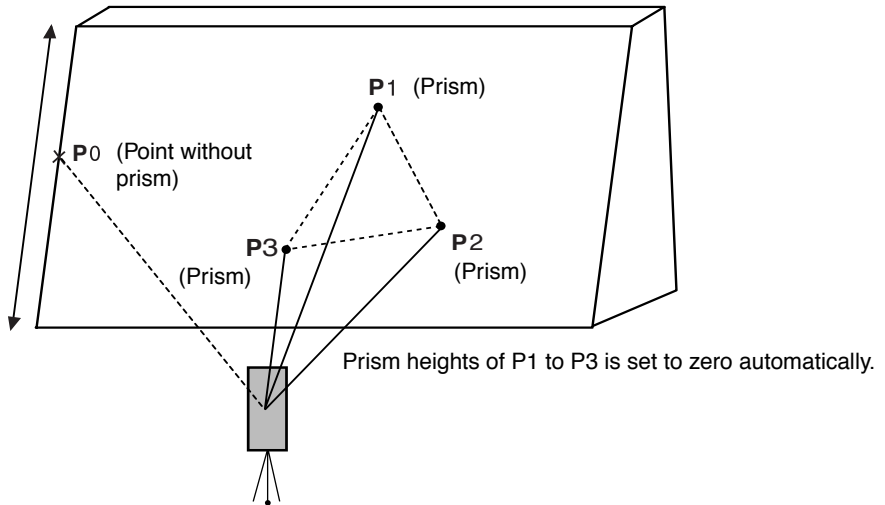

| Operating procedure                                                                                                                                  | Operation            | Display                                                                                               |
|------------------------------------------------------------------------------------------------------------------------------------------------------|----------------------|-------------------------------------------------------------------------------------------------------|
| 1 Press the [F3](MEAS) key.                                                                                                                          | [F3]                 | <pre>PT#    →PT-11 PCODE :TOPCON R.HT  :  1.200 m INPUT SRCH MEAS ALL VH  *HD  NEZ  OFSET</pre>       |
| 2 Press the [F4](OFFSET) key.                                                                                                                        | [F4]                 | <pre>OFFSET                1/2 F1:ANG.OFFSET F2:DIST.OFFSET F3:PLANE OFFSET  P↓</pre>                 |
| 3 Press the [F3](PLANE OFFSET) key.                                                                                                                  | [F3]                 | <pre>PLANE NO01#: SD:                m MEAS  ---  ---  ---</pre>                                      |
| 4 Collimate prism P1, and press the [F1](MEAS) key.<br>Measuring will start.<br>After measuring, the display will show the second point measurement. | Collimate P1<br>[F1] | <pre>PLANE NO01#: SD* [n]    &lt;&lt; m &gt;Measuring...</pre> <p style="text-align: center;">↓</p>   |
| 5 Measure the second and third points in the same way.                                                                                               | Collimate P2<br>[F1] | <pre>PLANE NO02#: SD:                m MEAS  ---  ---  ---</pre> <p style="text-align: center;">↓</p> |





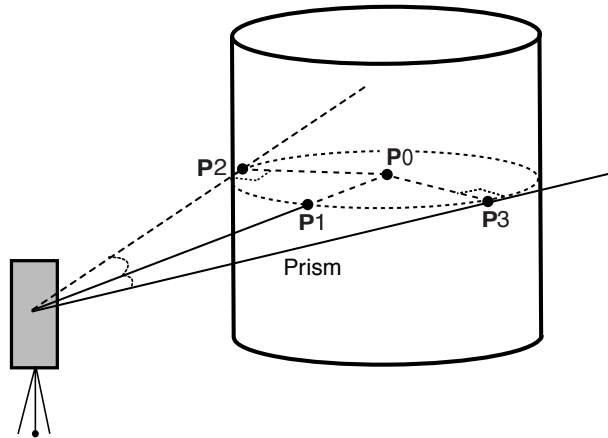

### 7.3.4 Column Offset Measurement

If it is possible to measure circumscription point (P1) of column directly, the distance to the center of the column (P0), coordinate and direction angle can be calculated by measured circumscription points (P2) and (P3).

The direction angle of the center of the column is 1/2 of total direction angle of circumscription points (P2) and (P3)..



| Operating procedure                                                                           | Operation            | Display                                                                                                                                                                                                                                                        |
|-----------------------------------------------------------------------------------------------|----------------------|----------------------------------------------------------------------------------------------------------------------------------------------------------------------------------------------------------------------------------------------------------------|
| 1 Press the [F3](MEAS) key.                                                                   | [F3]                 | <pre>PT#   → PT-11 PCODE :TOPCON R.HT  :  1.200 m <b>INPUT SRCH MEAS ALL</b> VH *SD  NEZ OFSET</pre>                                                                                                                                                           |
| 2 Press the [F4](OFSET) key.                                                                  | [F4]                 | <pre><b>OFFSET</b>                1/2 <b>F1:ANG.OFFSET</b> <b>F2:DIST.OFFSET</b> <b>F3:PLANE OFFSET</b>  P↓</pre>                                                                                                                                              |
| 3 Press the [F4](P1↓) key.                                                                    | [F4]                 | <pre><b>OFFSET</b>                2/2 <b>F1:COLUMN OFFSET</b>  P↓</pre>                                                                                                                                                                                        |
| 4 Press the [F1](COLUMN OFFSET) key.                                                          | [F1]                 | <pre><b>COLUMN OFFSET</b> <b>Center</b> <b>HD:</b>                m <b>MEAS</b>  ---  ---  ---</pre>                                                                                                                                                           |
| 5 Collimate the center of the column (P1) and press the [F1](MEAS) key. Measuring will start. | Collimate P1<br>[F1] | <pre><b>COLUMN OFFSET</b> <b>Center</b> <b>HD* [n]</b>            &lt;&lt; m <b>&gt;Measuring...</b></pre> <p style="text-align: center;">↓</p> <pre><b>COLUMN OFFSET</b> <b>Left</b> <b>HR:  120°30'40"</b> <b>---</b> <b>---</b> <b>---</b> <b>SET</b></pre> |
| After the measurement, angle measuring display of the left side (P2) will be shown.           |                      |                                                                                                                                                                                                                                                                |

|                                                                                                                                                                                                                                                                                                                                                                                                                                                                                                         |                                                                                              |                                                                                                                                                                             |
|---------------------------------------------------------------------------------------------------------------------------------------------------------------------------------------------------------------------------------------------------------------------------------------------------------------------------------------------------------------------------------------------------------------------------------------------------------------------------------------------------------|----------------------------------------------------------------------------------------------|-----------------------------------------------------------------------------------------------------------------------------------------------------------------------------|
| <p><b>6</b> Collimate the left side of the column (P2) and press the [F4](SET) key. After the measurement, angle measuring display of the right side (P3) will be shown.</p>                                                                                                                                                                                                                                                                                                                            | <p>Collimate<br/>P2<br/>[F4]</p>                                                             | <div style="border: 1px solid black; padding: 5px;"> <p><b>COLUMN OFFSET</b><br/> <b>Right</b><br/> <b>HR: 180°30'40"</b><br/> <b>--- --- --- SET</b></p> </div>            |
| <p><b>7</b> Collimate the right side of the column (P3) and press the [F4](SET) key. The distance between the instrument and center of the column (P0) will be calculated.</p>                                                                                                                                                                                                                                                                                                                          | <p>Collimate<br/>P3<br/>[F4]</p>                                                             | <div style="border: 1px solid black; padding: 5px;"> <p><b>COLUMN OFFSET</b><br/> <b>HR: 150°30'40"</b><br/> <b>HD: 43.321 m</b><br/> <b>&gt;OK? [YES] [NO]</b></p> </div>  |
| <p>To show the relative elevation (VD), press the [  ] key.</p> <p>Each time pressing the [  ] key, horizontal distance, relative elevation and slope distance are shown in sequence.</p> <p>To show coordinate of point P0, press the [  ] key.</p> | <p>[  ]</p> | <div style="border: 1px solid black; padding: 5px;"> <p><b>COLUMN OFFSET</b><br/> <b>HR: 150°30'40"</b><br/> <b>VD: 2.321 m</b><br/> <b>&gt;OK? [YES] [NO]</b></p> </div>   |
| <p><b>8</b> Press the [F3](YES) key. The display returns to the next point number in data collect mode.</p>                                                                                                                                                                                                                                                                                                                                                                                             | <p>[F3]</p>                                                                                  | <div style="border: 1px solid black; padding: 5px;"> <p><b>PT# → PT-12</b><br/> <b>PCODE : TOPCON</b><br/> <b>R.HT : 1.200 m</b><br/> <b>INPUT SRCH MEAS ALL</b></p> </div> |

## 7.4 NEZ Auto Calculation

As measured data is collected, coordinates are calculated and stored for traverse or topo collection. Automatic making out function of coordinate data sets up in CONFIG of data collect. Refer to Section 7.6 "Setting Parameter of Data Collect [CONFIG.]".

As a default, coordinate data calculated will be saved in a file of the same name as the measurement data file.

When the coordinate data file of the same name as the measurement data file does not exist, it will be generated automatically.

It is possible to change a file for saving coordinate data in the DATA COLLECT Menu 2/2 (F1:SELECT A FILE).

To calculate a coordinate data, it is necessary to add a point number in Data Collect execution.

When a coordinate data of the same point number exist already, it can be replaced with the new data by confirming display.

- **Coordinates will be calculated using the grid factor.**  
**To set the grid factor, see Section 6.2 "Setting the GRID FACTOR".**



## 7.5 Editing PCODE Library [PCODE INPUT]

PCODE data can be entered into PCODE Library in this mode.

A PCODE is liked with a number of 1 to 50.

PCODE can be also edited in MEMORY MANAGER menu 2/3 in the same way.

| Operating procedure                                                                                                                                                                          | Operation                | Display                                                                                                           |
|----------------------------------------------------------------------------------------------------------------------------------------------------------------------------------------------|--------------------------|-------------------------------------------------------------------------------------------------------------------|
| <p><b>1</b> Press the [F2](PCODE INPUT) key from Data Collect menu 2/2.</p>                                                                                                                  | [F2]                     | <pre>DATA COLLECT    2/2 F1:SELECT A FILE F2:PCODE INPUT F3:CONFIG.      P↓</pre>                                 |
| <p><b>2</b> By pressing the following keys, the list will increase or decrease.<br/> [▲] or [▼] : Increasing or Decreasing one by one<br/> [▶] or [◀] : By ten Increasing or Decreasing.</p> | [▲] or [▼]<br>[▶] or [◀] | <pre>→001:TOPCON 002:TOKYO EDIT  ——— CLR  ———</pre> <pre>011:URAH →012:AMIDAT 013:HILLTO EDIT  ——— CLR  ———</pre> |
| <p><b>3</b> Press the [F1](EDIT) key.</p>                                                                                                                                                    | [F1]                     | <pre>011:URAH →012=<u>A</u>MIDAT 013:HILLTO [ALP] [SPC] [CLR] [ENT]</pre>                                         |
| <p><b>4</b> Enter PCODE and press the [F4](ENT) key. *1)</p>                                                                                                                                 | Enter<br>PCODE<br>[F4]   | <pre>011:URAH →012:<u>A</u>MISUN 013:HILLTO EDIT  ——— CLR  ———</pre>                                              |
| <p>*1) Refer to Section 2.6 “How to Enter Alphanumeric characters”.</p>                                                                                                                      |                          |                                                                                                                   |

## 7.6 Setting Parameter of Data Collect [CONFIG.]

In this mode, the following settings of data collect mode are possible.

### ● Setting Items

| Menu              | Selecting Item               | Contents                                                                                                                                                                                     |
|-------------------|------------------------------|----------------------------------------------------------------------------------------------------------------------------------------------------------------------------------------------|
| F1:DIST MODE      | FINE / CRS(1) /<br>CRS(10)   | Select Fine /Coarse(1) /Coarse(10) mode in distance measurement mode.<br>The unit to be displayed is as follows.<br>Fine mode: 1mm (0.2mm)<br>Coarse (1) mode: 1mm<br>Coarse (10) mode: 10mm |
| F2:HD/SD          | HD/SD                        | Select the distance measurement mode Horizontal distance or Slope distance.                                                                                                                  |
| F3:MEAS. SEQ.     | N-TIMES /<br>SINGLE / REPEAT | Select to set measurement mode for distance measurement.                                                                                                                                     |
| F1:DATA CONFIRM   | YES/NO                       | It is possible to confirm the result of measuring data before the data is recorded.                                                                                                          |
| F2:COLLECT SEQ.   | [EDIT→MEAS] /<br>[MEAS→EDIT] | Select the procedure of data collection.<br>[EDIT→MEAS] :Measurement is carried out after entering other data.<br>[MEAS→EDIT] :Measurement is carried out before entering other data.        |
| F3:NEZ AUTO. CALC | ON/OFF                       | It is possible to calculate coordinate value of data collected and store it into coordinate data file in every data collection.                                                              |

### ● How to Set Items

Example Setting: DATA CONFIRM : YES

| Operating procedure                                                                                                                                                                                                                                                                                                                                                   | Operation | Display                                                                                                                           |
|-----------------------------------------------------------------------------------------------------------------------------------------------------------------------------------------------------------------------------------------------------------------------------------------------------------------------------------------------------------------------|-----------|-----------------------------------------------------------------------------------------------------------------------------------|
| <p><b>1</b> Press the [F3] (CONFIG.) key from the data collect menu 2/2.<br/>The CONFIG menu 1/2 is shown.</p> <p><b>2</b> Press the [F4](P↓) key to display the CONFIG menu 2/2.</p> <p><b>3</b> Press the [F1] (DATA CONFIRM) key.<br/>[ ] indicates the current setting.</p> <p><b>4</b> Press the [F1] (YES) key.</p> <p><b>5</b> Press the [F4] (ENTER) key.</p> | [F3]      | <pre> <b>DATA COLLECT</b>      2 / 2 <b>F1:SELECT A FILE</b> <b>F2:PCODE INPUT</b> <b>F3:CONFIG.</b>          P↓           </pre> |
|                                                                                                                                                                                                                                                                                                                                                                       | [F4]      | <pre> <b>CONFIG.</b>            1 / 2 <b>F1:DIST MODE</b> <b>F2:HD/SD</b> <b>F3:MEAS. SEQ.</b>      P↓           </pre>           |
|                                                                                                                                                                                                                                                                                                                                                                       | [F4]      | <pre> <b>CONFIG.</b>            2 / 2 <b>F1:DATA CONFIRM</b> <b>F2:COLLECT SEQ.</b> <b>F3:NEZ AUTO. CALC</b> P↓           </pre>  |
|                                                                                                                                                                                                                                                                                                                                                                       | [F1]      | <pre> <b>DATA CONFIRM</b> <b>F1:YES</b> <b>[F2:NO ]</b> <b>ENTER</b>           </pre>                                             |
|                                                                                                                                                                                                                                                                                                                                                                       | [F1]      | <pre> <b>DATA CONFIRM</b> <b>[F1:YES]</b> <b>F2:NO</b> <b>ENTER</b>           </pre>                                              |
| [F4]                                                                                                                                                                                                                                                                                                                                                                  |           |                                                                                                                                   |

## 8 LAYOUT

LAYOUT mode has two functions which are setting of layout points and setting new points using coordinate data in the internal memory.

Also, if the coordinate data is not stored in the internal memory, this can be input from key board.

The coordinate data is loaded from PC to the internal memory via RS-232C.

- The coordinate data

The coordinate data is memorized into a file.

For the internal memory, refer to Chapter 9 “MEMORY MANAGER MODE”.

The GTS-230N series are able to store the coordinate data into the internal memory.

The internal memory is shared by the measured data and the coordinate data for layout.

Maximum 30 files can be generated.

- **The number of coordinate data**

( In case not using the internal memory in the data collect mode)

|                    |
|--------------------|
| MAX. 24,000 points |
|--------------------|

Because the internal memory covers both data collection mode and layout mode, the number of coordinate data will be decreased when the data collection mode is used.

- 1) **When turning off the power, ensure that you are in the main menu screen or main angle measurement mode.**  
**This ensures completion of the memory access process and avoids possible damage to the stored data.**
- 2) It is recommended for safety to charge the battery (BT-52QA) beforehand and prepare fully charged spare batteries.
- 3) When recording new point data, remember to consider the amount of internal memory available.

● **Layout menu operation**

By pressing the [MENU] key, the instrument will be in MENU 1/3 mode.  
 Press the [F2](LAYOUT) key, the menu of layout 1/2 will be shown.

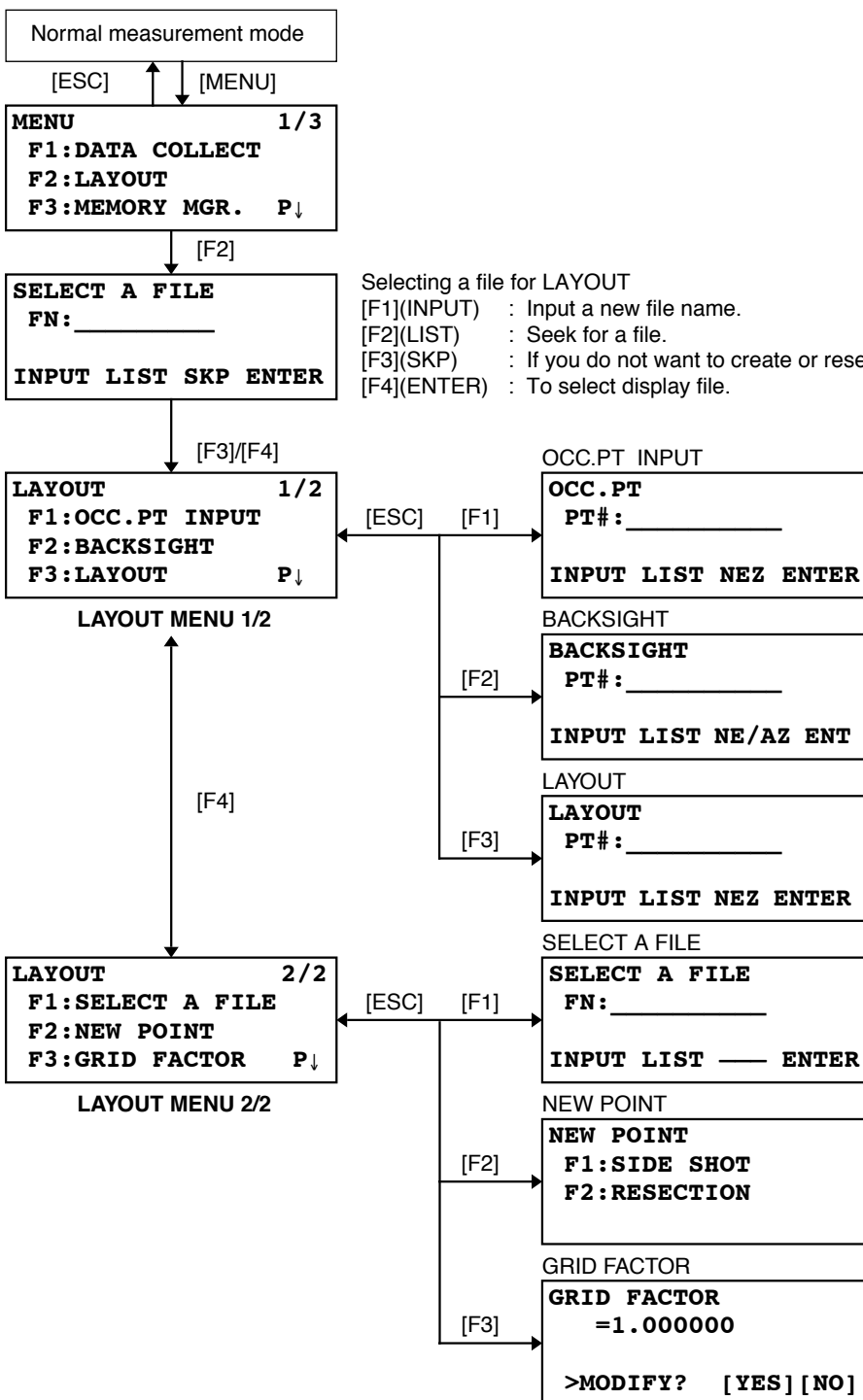

Selecting a file for LAYOUT  
 [F1](INPUT) : Input a new file name.  
 [F2](LIST) : Seek for a file.  
 [F3](SKP) : If you do not want to create or reselect a file.  
 [F4](ENTER) : To select display file.

## 8.1 Preparation

### 8.1.1 Setting the GRID FACTOR

● **Calculation Formula**

1) Elevation Factor

$$\text{Elevation Factor} = \frac{R}{R + \text{ELEV.}}$$

$R$  : The average radius of the earth  
 $\text{ELEV.}$  : The elevation above mean sea level

2) Scale Factor

*Scale Factor* : Scale Factor at the surveying station

3) Grid Factor

$$\text{Grid Factor} = \text{Elevation Factor} \times \text{Scale Factor}$$

**Distance Calculation**

1) Grid Distance

$$\text{HDg} = \text{HD} \times \text{Grid Factor}$$

$\text{HDg}$  : Grid distance  
 $\text{HD}$  : Ground distance

2) Ground Distance

$$\text{HD} = \frac{\text{HDg}}{\text{Grid Factor}}$$

● **How to Set Grid Factor**

| Operating procedure                                                                                                                                                                                                                                                                                                                                            | Operation                   | Display                                                                                                                                                                                                  |
|----------------------------------------------------------------------------------------------------------------------------------------------------------------------------------------------------------------------------------------------------------------------------------------------------------------------------------------------------------------|-----------------------------|----------------------------------------------------------------------------------------------------------------------------------------------------------------------------------------------------------|
| <p><b>1</b> Press the [F3](GRID FACTOR) key from the Layout menu 2/2.</p> <p><b>2</b> Press the [F3](YES) key.</p> <p><b>3</b> Press the [F1] (INPUT) key and enter Elevation.<br/>*1) Press the [F4](ENT) key.</p> <p><b>4</b> Enter Scale Factor in the same way.<br/>Grid Factor is displayed for 1 to 2 second and display returns to Layout menu 2/2.</p> | [F3]                        | <div style="border: 1px solid black; padding: 5px;"> <p>LAYOUT 2/2<br/>                     F1:SELECT A FILE<br/>                     F2:NEW POINT<br/>                     F3:GRID FACTOR P↓</p> </div> |
|                                                                                                                                                                                                                                                                                                                                                                | [F3]                        | <div style="border: 1px solid black; padding: 5px;"> <p>GRID FACTOR<br/>                     =0.998843<br/>                     &gt;MODIFY? [YES] [NO]</p> </div>                                        |
|                                                                                                                                                                                                                                                                                                                                                                | [F1]<br>Enter ELEV.<br>[F4] | <div style="border: 1px solid black; padding: 5px;"> <p>GRID FACTOR<br/>                     ELEV.→1000 m<br/>                     SCALE:0.999000<br/>                     INPUT — — ENTER</p> </div>    |
|                                                                                                                                                                                                                                                                                                                                                                | [F1]<br>Enter Scale<br>[F4] | <div style="border: 1px solid black; padding: 5px;"> <p>GRID FACTOR<br/>                     ELEV.:2000 m<br/>                     SCALE→1.001000<br/>                     INPUT — — ENTER</p> </div>    |
| <p>*1) Refer to Section 2.6 “How to Enter Alphanumeric characters”.</p> <p>● Input Range :Elevation : -9,999 to +9,999 meter (-32,805 to +3,2805 ft, ft+in)<br/>                     Scale Factor : 0.990000 to 1.010000</p>                                                                                                                                   |                             |                                                                                                                                                                                                          |

### 8.1.2 Selecting Coordinate Data File

You can execute a Layout from selected coordinate data file, also you can record New point measured data into the selected coordinate data file.

- The only coordinate data file existing can be selected and you can not make a new file in this mode. For more information about File, refer to Chapter 9 “MEMORY MANAGER MODE”.
- When LAYOUT MODE is begun, a file can be selected in the same way.

| Operating procedure                                                                                                                                                                                                                                                                                                                                                                                            | Operation | Display                                                                              |
|----------------------------------------------------------------------------------------------------------------------------------------------------------------------------------------------------------------------------------------------------------------------------------------------------------------------------------------------------------------------------------------------------------------|-----------|--------------------------------------------------------------------------------------|
| <p><b>1</b> Press the [F1](SELECT A FILE) key from the Layout menu 2/2.</p>                                                                                                                                                                                                                                                                                                                                    | [F1]      | <pre>LAYOUT                2/2 F1:SELECT A FILE F2:NEW POINT F3:GRID FACTOR P↓</pre> |
| <p><b>2</b> Press the [F2](LIST) key to display the list of coordinate data file.*1)</p>                                                                                                                                                                                                                                                                                                                       | [F2]      | <pre>SELECT A FILE FN:_____ INPUT LIST  —  ENTER</pre>                               |
| <p><b>3</b> Scroll file list by pressing the [▲]or[▼] key and select a file to use. *2),3)</p>                                                                                                                                                                                                                                                                                                                 | [▲]or[▼]  | <pre>COORDDATA /C0123 →*TOKBDATA /C0345 TOPCDATA  /C0789 —  SRCH  —  ENTER</pre>     |
| <p><b>4</b> Press the [F4](ENTER) key. The file will be set .</p>                                                                                                                                                                                                                                                                                                                                              | [F4]      | <pre>*TOKBDATA /C0345 → TOPCDATA /C0789 SATIDATA  /C0456 —  SRCH  —  ENTER</pre>     |
| <p><b>4</b> Press the [F4](ENTER) key. The file will be set .</p>                                                                                                                                                                                                                                                                                                                                              | [F4]      | <pre>LAYOUT                2/2 F1:SELECT A FILE F2:NEW POINT F3:GRID FACTOR P↓</pre> |
| <p>*1) If you want to input file name directly, press the [F1](INPUT) key and enter a file name.<br/>           *2) When a file has been selected already, “*” mark is indicated on left of current file name. For the file discrimination mark (*, @, &amp;), refer to Section 9.3 “FILE MAINTENANCE”.<br/>           *3) Data in a file shown with arrow can be searched by pressing the [F2](SRCH) key.</p> |           |                                                                                      |

### 8.1.3 Setting Occupied Point

Occupied point can be set by two setting methods as follows.

- 1) Setting from the coordinate data stored in the internal memory.
- 2) Direct key input of coordinate data.

- Example setting :Setting the occupied point from the internal coordinate data file

| Operating procedure                                                                   | Operation                       | Display                                                                                      |
|---------------------------------------------------------------------------------------|---------------------------------|----------------------------------------------------------------------------------------------|
| <b>1</b> Press the [F1](OCC.PT INPUT) key from the Layout menu 1/2.                   | [F1]                            | <b>OCC. PT</b><br><b>PT#:</b> _____<br><b>INPUT LIST NEZ ENTER</b>                           |
| <b>2</b> Press the [F1] (INPUT) key , enter PT# and press the [F4](ENT) key. *1)      | [F1]<br>Enter PT#<br>[F4]       | <b>INSTRUMENT HEIGHT</b><br><b>INPUT</b><br><b>INS.HT: 0.000 m</b><br><b>INPUT — — ENTER</b> |
| <b>3</b> Enter INS.HT in the same way.<br><br>The display returns to layout menu 1/2. | [F1]<br>Enter<br>INS.HT<br>[F4] | <b>LAYOUT 1/2</b><br><b>F1:OCC.PT INPUT</b><br><b>F2:BACKSIGHT</b><br><b>F3:LAYOUT P↓</b>    |
| *1) Refer to Section 2.6 “How to Enter Alphanumeric characters”.                      |                                 |                                                                                              |

- Example setting :Setting Instrument point coordinates directly

| Operating procedure                                                                               | Operation                       | Display                                                                                      |
|---------------------------------------------------------------------------------------------------|---------------------------------|----------------------------------------------------------------------------------------------|
| <b>1</b> Press the [F1](OCC.PT INPUT) key from the Layout menu 1/2.                               | [F1]                            | <b>OCC. PT</b><br><b>PT#:</b><br><b>INPUT LIST NEZ ENTER</b>                                 |
| <b>2</b> Press the [F3] (NEZ) key.                                                                | [F3]                            | <b>N→ 0.000 m</b><br><b>E: 0.000 m</b><br><b>Z: 0.000 m</b><br><b>INPUT --- PT# ENTER</b>    |
| <b>3</b> Press the [F1](INPUT) key and enter coordinate value.<br>press the [F4](ENT) key. *1),2) | [F1]<br>Enter coord.<br>[F4]    | <b>COORD.DATA INPUT</b><br><b>PT#:</b><br><b>INPUT — — ENTER</b>                             |
| <b>4</b> Press the [F1](INPUT) key and enter PT#. Press the [F4](ENT) key. *2)                    | [F1]<br>Enter PT#<br>[F4]       | <b>INSTRUMENT HEIGHT</b><br><b>INPUT</b><br><b>INS.HT: 0.000 m</b><br><b>INPUT — — ENTER</b> |
| <b>5</b> Enter Instrument Height in the same way.<br><br>The display returns to layout menu 1/2.  | [F1]<br>Enter<br>INS.HT<br>[F4] | <b>LAYOUT 1/2</b><br><b>F1:OCC.PT INPUT</b><br><b>F2:BACKSIGHT</b><br><b>F3:LAYOUT P↓</b>    |
| *1) Refer to Section 2.6 “How to Enter Alphanumeric characters”.                                  |                                 |                                                                                              |
| *2) It is possible to record the coordinate value. Refer to Chapter 16 “SELECTING MODE”.          |                                 |                                                                                              |

### 8.1.4 Setting Backsight Point

The following three setting methods for Backsight point can be selected.

- 1) Setting from the coordinate data file stored in the internal memory.
- 2) Direct key input of coordinate data.
- 3) Direct key input of setting angle.

- Example setting :Setting the backsight point from the internal coordinate data file

| Operating procedure                                                                                            | Operation         | Display                                                            |
|----------------------------------------------------------------------------------------------------------------|-------------------|--------------------------------------------------------------------|
| <b>1</b> Press the [F2](BACKSIGHT) key from the Layout menu 1/2.                                               | [F2]              | <b>BACKSIGHT</b><br>PT# : _____<br><b>INPUT LIST NE/AZ ENT</b>     |
| <b>2</b> Press the [F1] (INPUT) key.                                                                           | [F1]              | <b>BACKSIGHT</b><br>PT#=BK-01<br><b>[ALP] [SPC] [CLR] [ENT]</b>    |
| <b>3</b> Enter PT#, press the [F4](ENT) key. *1)                                                               | Enter PT#<br>[F4] | <b>BACKSIGHT</b><br>H(B)= 0°00'00"<br><b>&gt;Sight ? [YES][NO]</b> |
| <b>4</b> Sight the backsight point and press the [F3](YES) key.<br>The display returns to the layout menu 1/2. | Sight BK<br>[F3]  |                                                                    |

\*1) Refer to Section 2.6 "How to enter alphanumeric characters".

- With each pressing of [F3] key, method of inputting backsight is changed.

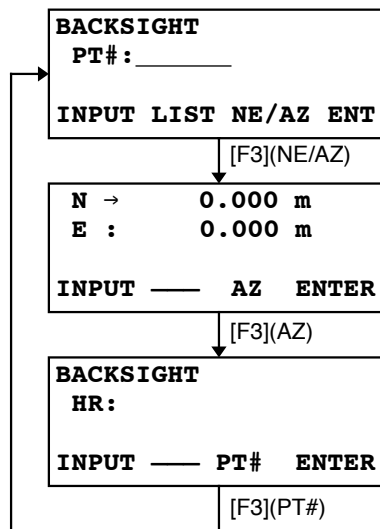





## 8.2 Executing a Layout

The following methods can be selected for executing a Layout:

- 1) Recalling points from internal memory by point number.
- 2) Direct key input of coordinate values.

Example setting : Recalling point from internal memory.

| Operating procedure                                                                                                                                                                                                                                                                                                        | Operation                  | Display                                                                                                                                                                 |
|----------------------------------------------------------------------------------------------------------------------------------------------------------------------------------------------------------------------------------------------------------------------------------------------------------------------------|----------------------------|-------------------------------------------------------------------------------------------------------------------------------------------------------------------------|
|                                                                                                                                                                                                                                                                                                                            |                            | <pre>LAYOUT 1/2 F1:OCC.PT INPUT F2:BACKSIGHT F3:LAYOUT P↓</pre>                                                                                                         |
| 1 Press the [F3](LAYOUT) key from the layout menu 1/2.                                                                                                                                                                                                                                                                     | [F3]                       | <pre>LAYOUT PT#: _____ INPUT LIST NEZ ENTER</pre>                                                                                                                       |
| 2 Press the [F1](INPUT) key, and enter PT#. *1)<br>Press the [F4](ENT) key. *2)                                                                                                                                                                                                                                            | [F1]<br>Enter PT#<br>[F4]  | <pre>REFLECTOR HEIGHT INPUT R.HT : 0.000 m INPUT — — ENTER</pre>                                                                                                        |
| 3 Enter reflector height in the same way.<br><br>When the layout point is set, the instrument will start layout calculation.<br>HR: Calculated horizontal angle of the layout point<br>HD: Calculated horizontal distance from the instrument to the layout point                                                          | [F1]<br>Enter R.HT<br>[F4] | <pre>CALCULATED HR= 90°10'20" HD= 123.456 m ANGLE DIST — —</pre>                                                                                                        |
| 4 Collimate the prism, and press the [F1](ANGLE) key.<br>PT#: Layout point<br>HR: Measured (Actual) horizontal angle.<br>dHR: Horizontal angle to be turned to the layout point = Actual horizontal angle - Calculated horizontal angle.<br>Correct direction when dHR = 0°00'00"                                          | Collimate P<br>[F1]        | <pre>PT#: LP-100 HR: 6°20'40" dHR: 23°40'20" DIST — NEZ —</pre>                                                                                                         |
| 5 Press the [F1](DIST) key.<br>HD: Measuring (Actual) horizontal distance<br>dHD: Horizontal distance to be turned to the layout point = Actual horizontal distance – Calculated horizontal distance.<br>dZ: Vertical distance to be turned to the layout point = Actual vertical distance – Calculated vertical distance. | [F1]                       | <pre>HD* [t] &lt; m dHD: m dZ: m MODE ANGLE NEZ NEXT</pre> <p style="text-align: center;">↓</p> <pre>HD* 143.84 m dHD: -13.34 m dZ: -0.05 m MODE ANGLE NEZ NEXT</pre>   |
| 6 Press the [F1](MODE) key.<br>The fine mode measuring starts.                                                                                                                                                                                                                                                             | [F1]                       | <pre>HD* [r] &lt; m dHD: m dZ: m MODE ANGLE NEZ NEXT</pre> <p style="text-align: center;">↓</p> <pre>HD* 156.835 m dHD: -3.327 m dZ: -0.046 m MODE ANGLE NEZ NEXT</pre> |

|                                                                                                                                                                                                                                                                                             |                  |                                                                                                                                                                                                                                                                   |               |                    |                             |                  |            |                |                   |               |
|---------------------------------------------------------------------------------------------------------------------------------------------------------------------------------------------------------------------------------------------------------------------------------------------|------------------|-------------------------------------------------------------------------------------------------------------------------------------------------------------------------------------------------------------------------------------------------------------------|---------------|--------------------|-----------------------------|------------------|------------|----------------|-------------------|---------------|
| <p><b>7</b> When the display value dHR, dHD and dZ are equal to 0, the layout point is established.*3</p>                                                                                                                                                                                   |                  |                                                                                                                                                                                                                                                                   |               |                    |                             |                  |            |                |                   |               |
| <p><b>8</b> Press the [F3](NEZ) key.<br/>The coordinate data is shown.</p>                                                                                                                                                                                                                  | [F3]             | <table border="1"> <tr> <td><b>N *</b></td> <td><b>100.000 m</b></td> </tr> <tr> <td><b>E :</b></td> <td><b>100.000 m</b></td> </tr> <tr> <td><b>Z :</b></td> <td><b>1.015 m</b></td> </tr> <tr> <td><b>MODE ANGLE</b></td> <td><b>— NEXT</b></td> </tr> </table> | <b>N *</b>    | <b>100.000 m</b>   | <b>E :</b>                  | <b>100.000 m</b> | <b>Z :</b> | <b>1.015 m</b> | <b>MODE ANGLE</b> | <b>— NEXT</b> |
| <b>N *</b>                                                                                                                                                                                                                                                                                  | <b>100.000 m</b> |                                                                                                                                                                                                                                                                   |               |                    |                             |                  |            |                |                   |               |
| <b>E :</b>                                                                                                                                                                                                                                                                                  | <b>100.000 m</b> |                                                                                                                                                                                                                                                                   |               |                    |                             |                  |            |                |                   |               |
| <b>Z :</b>                                                                                                                                                                                                                                                                                  | <b>1.015 m</b>   |                                                                                                                                                                                                                                                                   |               |                    |                             |                  |            |                |                   |               |
| <b>MODE ANGLE</b>                                                                                                                                                                                                                                                                           | <b>— NEXT</b>    |                                                                                                                                                                                                                                                                   |               |                    |                             |                  |            |                |                   |               |
| <p><b>9</b> Press the [F4](NEXT) key to set next layout point .<br/>PT# is automatically incremented.</p>                                                                                                                                                                                   | [F4]             | <table border="1"> <tr> <td><b>LAYOUT</b></td> </tr> <tr> <td><b>PT#: LP-101</b></td> </tr> <tr> <td><b>INPUT LIST NEZ ENTER</b></td> </tr> </table>                                                                                                              | <b>LAYOUT</b> | <b>PT#: LP-101</b> | <b>INPUT LIST NEZ ENTER</b> |                  |            |                |                   |               |
| <b>LAYOUT</b>                                                                                                                                                                                                                                                                               |                  |                                                                                                                                                                                                                                                                   |               |                    |                             |                  |            |                |                   |               |
| <b>PT#: LP-101</b>                                                                                                                                                                                                                                                                          |                  |                                                                                                                                                                                                                                                                   |               |                    |                             |                  |            |                |                   |               |
| <b>INPUT LIST NEZ ENTER</b>                                                                                                                                                                                                                                                                 |                  |                                                                                                                                                                                                                                                                   |               |                    |                             |                  |            |                |                   |               |
| <p>*1) Refer to Section 2.6 “How to Enter Alphanumeric characters”.<br/>*2) Point number could not be entered when data to comply with the coordinate value does not exist in the file.<br/>*3) Cut &amp; Fill displaying function is available . Refer to Chapter 16 “SELECTING MODE”.</p> |                  |                                                                                                                                                                                                                                                                   |               |                    |                             |                  |            |                |                   |               |

● **Point Guide Function (Only for Point Guide type)**

The point guide function can be used while executing a Layout.

| Operating procedure                                                                  | Operation            | Display                                                                                                                                                                                                                                                                              |                        |                       |                       |                         |                         |                       |
|--------------------------------------------------------------------------------------|----------------------|--------------------------------------------------------------------------------------------------------------------------------------------------------------------------------------------------------------------------------------------------------------------------------------|------------------------|-----------------------|-----------------------|-------------------------|-------------------------|-----------------------|
| <p><b>1</b> After measuring Angle, Distance or Coordinate, press the [MENU] key.</p> | [MENU]               | <table border="1"> <tr> <td><b>PT#:P1003</b></td> </tr> <tr> <td><b>HR: 6°20'40"</b></td> </tr> <tr> <td><b>dHR: 23°40'20"</b></td> </tr> <tr> <td><b>DIST --- NEZ ---</b></td> </tr> <tr> <td><b>POINTGUIDE [OFF]</b></td> </tr> <tr> <td><b>— — [ON] [OFF]</b></td> </tr> </table> | <b>PT#:P1003</b>       | <b>HR: 6°20'40"</b>   | <b>dHR: 23°40'20"</b> | <b>DIST --- NEZ ---</b> | <b>POINTGUIDE [OFF]</b> | <b>— — [ON] [OFF]</b> |
| <b>PT#:P1003</b>                                                                     |                      |                                                                                                                                                                                                                                                                                      |                        |                       |                       |                         |                         |                       |
| <b>HR: 6°20'40"</b>                                                                  |                      |                                                                                                                                                                                                                                                                                      |                        |                       |                       |                         |                         |                       |
| <b>dHR: 23°40'20"</b>                                                                |                      |                                                                                                                                                                                                                                                                                      |                        |                       |                       |                         |                         |                       |
| <b>DIST --- NEZ ---</b>                                                              |                      |                                                                                                                                                                                                                                                                                      |                        |                       |                       |                         |                         |                       |
| <b>POINTGUIDE [OFF]</b>                                                              |                      |                                                                                                                                                                                                                                                                                      |                        |                       |                       |                         |                         |                       |
| <b>— — [ON] [OFF]</b>                                                                |                      |                                                                                                                                                                                                                                                                                      |                        |                       |                       |                         |                         |                       |
| <p><b>2</b> Press the [F3](ON) or [MENU] key.</p>                                    | [F3]<br>or<br>[MENU] | <table border="1"> <tr> <td><b>POINTGUIDE [ON]</b></td> </tr> <tr> <td><b>— — [ON] [OFF]</b></td> </tr> </table>                                                                                                                                                                     | <b>POINTGUIDE [ON]</b> | <b>— — [ON] [OFF]</b> |                       |                         |                         |                       |
| <b>POINTGUIDE [ON]</b>                                                               |                      |                                                                                                                                                                                                                                                                                      |                        |                       |                       |                         |                         |                       |
| <b>— — [ON] [OFF]</b>                                                                |                      |                                                                                                                                                                                                                                                                                      |                        |                       |                       |                         |                         |                       |
| <p><b>3</b> Press the [ESC] key to return to the previous display.</p>               | [ESC]                | <table border="1"> <tr> <td><b>PT#:P1003</b></td> </tr> <tr> <td><b>HR: 6°20'40"</b></td> </tr> <tr> <td><b>dHR: 23°40'20"</b></td> </tr> <tr> <td><b>DIST --- NEZ ---</b></td> </tr> </table>                                                                                       | <b>PT#:P1003</b>       | <b>HR: 6°20'40"</b>   | <b>dHR: 23°40'20"</b> | <b>DIST --- NEZ ---</b> |                         |                       |
| <b>PT#:P1003</b>                                                                     |                      |                                                                                                                                                                                                                                                                                      |                        |                       |                       |                         |                         |                       |
| <b>HR: 6°20'40"</b>                                                                  |                      |                                                                                                                                                                                                                                                                                      |                        |                       |                       |                         |                         |                       |
| <b>dHR: 23°40'20"</b>                                                                |                      |                                                                                                                                                                                                                                                                                      |                        |                       |                       |                         |                         |                       |
| <b>DIST --- NEZ ---</b>                                                              |                      |                                                                                                                                                                                                                                                                                      |                        |                       |                       |                         |                         |                       |

### 8.3 Setting a New Point

New point is required for example when a layout point cannot be sighted from existing control points.

#### 8.3.1 Side Shot Method

Set up the instrument at a known point, and measure the coordinate of the new points by the side shot method

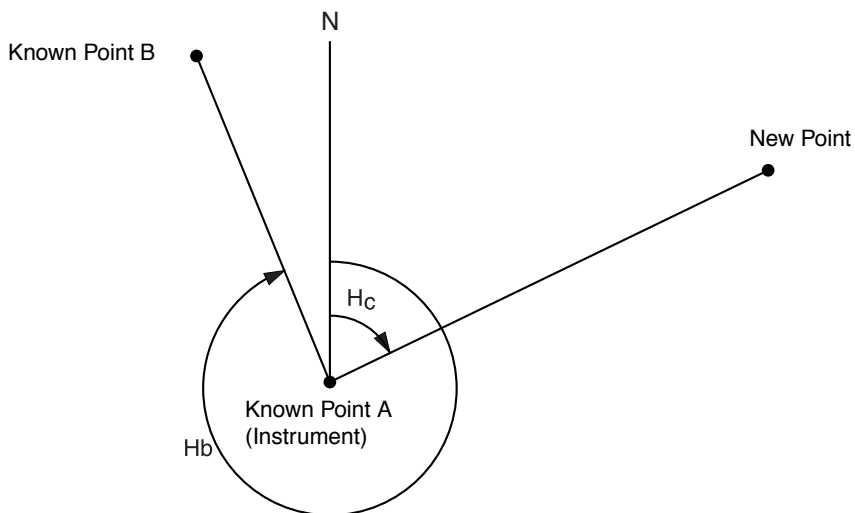

| Operating procedure                                                                                                                                                                                                                                                                                                                                                       | Operation | Display                                                                                  |
|---------------------------------------------------------------------------------------------------------------------------------------------------------------------------------------------------------------------------------------------------------------------------------------------------------------------------------------------------------------------------|-----------|------------------------------------------------------------------------------------------|
| <p><b>1</b> Press the [F4](↓) key from the layout menu 1/2 to get the layout menu 2/2.</p> <p><b>2</b> Press the [F2](NEW POINT).</p> <p><b>3</b> Press the [F1](SIDE SHOT) key.</p> <p><b>4</b> Press the [F2](LIST) key to display the list of coordinate data file. *1)</p> <p><b>5</b> Scroll file list by pressing [▲]or[▼] key and select a file to use. *2),3)</p> | [F4]      | <pre>LAYOUT          1/2 F1:OCC.PT INPUT F2:BACKSIGHT F3:LAYOUT       P↓</pre>           |
|                                                                                                                                                                                                                                                                                                                                                                           | [F2]      | <pre>LAYOUT          2/2 F1:SELECT A FILE F2:NEW POINT F3:GRID FACTOR P↓</pre>           |
|                                                                                                                                                                                                                                                                                                                                                                           | [F1]      | <pre>NEW POINT F1:SIDE SHOT F2:RESECTION</pre>                                           |
|                                                                                                                                                                                                                                                                                                                                                                           | [F2]      | <pre>SELECT A FILE FN: _____ INPUT LIST  _____ENTER</pre>                                |
|                                                                                                                                                                                                                                                                                                                                                                           | [▲]or[▼]  | <pre>COORDDATA /C0123 →*TOKBDATA /C0345 TOPCDATA  /C0789   _____ SRCH  _____ ENTER</pre> |
|                                                                                                                                                                                                                                                                                                                                                                           |           | <pre>*TOKBDATA /C0345 → TOPCDATA /C0789 SATIDATA  /C0456   _____ SRCH  _____ ENTER</pre> |

|                                                                                                                                                                                                                                                                                                                                                                                                                                                                                                                                    |                            |                                                                                                                                                     |
|------------------------------------------------------------------------------------------------------------------------------------------------------------------------------------------------------------------------------------------------------------------------------------------------------------------------------------------------------------------------------------------------------------------------------------------------------------------------------------------------------------------------------------|----------------------------|-----------------------------------------------------------------------------------------------------------------------------------------------------|
| <p><b>6</b> Press the [F4](ENTER) key.<br/>The file will be set .</p>                                                                                                                                                                                                                                                                                                                                                                                                                                                              | [F4]                       | <pre> <b>SIDE SHOT</b> PT#: _____ <b>INPUT SRCH — ENTER</b> </pre>                                                                                  |
| <p><b>7</b> Press the [F1](INPUT) key, and enter the new point name. *4)<br/>Press the [F4](ENT) key.</p>                                                                                                                                                                                                                                                                                                                                                                                                                          | [F1]<br>Enter PT#<br>[F4]  | <pre> <b>REFLECTOR HEIGHT</b> <b>INPUT</b> R.HT : 0.000 m <b>INPUT — ENTER</b> </pre>                                                               |
| <p><b>8</b> Enter reflector height in the same way.</p>                                                                                                                                                                                                                                                                                                                                                                                                                                                                            | [F1]<br>Enter R.HT<br>[F4] | <pre> <b>REFLECTOR HEIGHT</b> <b>INPUT</b> R.HT : 1.235 m &gt;Sight ? [YES][NO] </pre>                                                              |
| <p><b>9</b> Collimate the new point, and press the [F3](YES) key.<br/>Distance measuring starts.</p>                                                                                                                                                                                                                                                                                                                                                                                                                               | Collimate<br>[F3]          | <pre> HR: 123°40'20" HD*[n] &lt; m VD: m &gt; Measuring... &lt; complete &gt; ↓ N : 1234.567 m E : 123.456 m Z : 1.234 m &gt;REC ? [YES][NO] </pre> |
| <p><b>10</b> Press the [F3](YES) key.*5)<br/>The name and coordinate value are stored into COORD.DATA.<br/>The input menu for next new point is displayed.<br/>PT# is automatically incremented.</p>                                                                                                                                                                                                                                                                                                                               | [F3]                       | <pre> <b>SIDE SHOT</b> PT#:NP-101 <b>INPUT SRCH — ENTER</b> </pre>                                                                                  |
| <p>*1) If you want to input file name directly, press the [F1](INPUT) key and enter a file name.<br/>*2) When a file has been selected already, '*' mark is indicated on left of current file name.<br/>For the file discrimination mark (*, @, &amp;), refer to Chapter 9.3 "FILE MAINTENANCE".<br/>*3) Data in a file shown with arrow can be searched by pressing [F2](SRCH) key.<br/>*4) Refer to Section 2.6 "How to Enter Alphanumeric characters".<br/>*5) An error will be displayed when the internal memory is full.</p> |                            |                                                                                                                                                     |

### 8.3.2 Resection Method

Set up the instrument at a new point, and calculate the coordinate of the new point using the coordinate data of maximum seven known points and the measurements made to these points.

By following observation, resection is possible.

- Resection by distance measurement: 2 or more points must be measured
- Resection by angle measurement only: 3 or more points must be measured

An occupied point coordinate value will be calculated by the method of least squares.

(In case that 3 known points are measured by angle measurement only, the value would not be calculated by the method of least squares.)

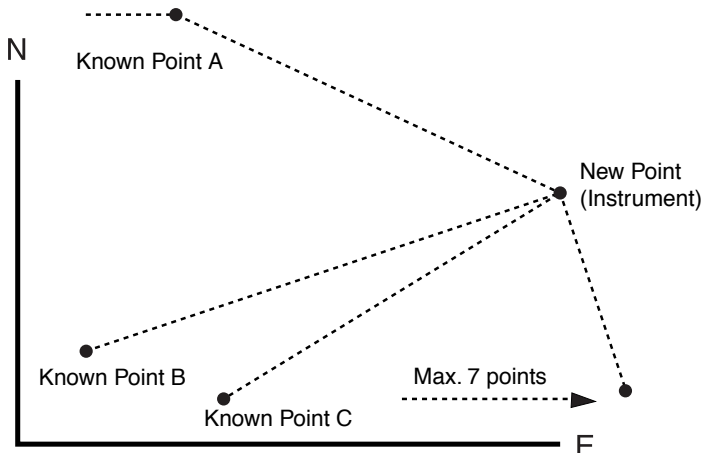

| Operating procedure                                                                                                                                                                                                                                                                                | Operation                 | Display                                                                                                                                                        |
|----------------------------------------------------------------------------------------------------------------------------------------------------------------------------------------------------------------------------------------------------------------------------------------------------|---------------------------|----------------------------------------------------------------------------------------------------------------------------------------------------------------|
| <p><b>1</b> Press the [F4](↓) key from the layout menu 1/2 to get the layout menu 2/2.</p> <p><b>2</b> Press the [F2](NEW POINT).</p> <p><b>3</b> Press the [F2](RESECTION) key.</p> <p><b>4</b> Press the [F1](INPUT) key, and enter the new point name. *1) ,2)<br/>Press the [F4](ENT) key.</p> | [F4]                      | <div style="border: 1px solid black; padding: 5px;"> <p><b>LAYOUT</b> 1/2</p> <p>F1:OCC.PT INPUT</p> <p>F2:BACKSIGHT</p> <p>F3:LAYOUT P↓</p> </div>            |
|                                                                                                                                                                                                                                                                                                    | [F2]                      | <div style="border: 1px solid black; padding: 5px;"> <p><b>LAYOUT</b> 2/2</p> <p>F1:SELECT A FILE</p> <p>F2:NEW POINT</p> <p>F3:GRID FACTOR P↓</p> </div>      |
|                                                                                                                                                                                                                                                                                                    | [F2]                      | <div style="border: 1px solid black; padding: 5px;"> <p><b>NEW POINT</b></p> <p>F1:SIDE SHOT</p> <p>F2:RESECTION</p> </div>                                    |
|                                                                                                                                                                                                                                                                                                    | [F1]<br>Enter PT#<br>[F4] | <div style="border: 1px solid black; padding: 5px;"> <p><b>NEW POINT</b></p> <p>PT#: _____</p> <p><b>INPUT SRCH SKP ENTER</b></p> </div>                       |
|                                                                                                                                                                                                                                                                                                    |                           | <div style="border: 1px solid black; padding: 5px;"> <p><b>INSTRUMENT HEIGHT</b></p> <p><b>INPUT</b></p> <p>INS.HT : 0.000 m</p> <p>INPUT — — ENTER</p> </div> |

**5** Enter instrument height in the same way.

[F1]  
Enter  
INS.HT  
[F4]

```
NO01#
PT#: _____
INPUT LIST NEZ ENTER
```

**6** Enter the known point A number. \*3)

[F1]  
Enter PT#  
[F4]

```
REFLECTOR HEIGHT
INPUT
R.HT : 0.000 m
INPUT — — ENTER
```

**7** Enter reflector height.

[F1]  
Enter R.HT  
[F4]

```
REFLECTOR HEIGHT
INPUT
R.HT : 1.235 m
>Sight ? ANG DIST
```

**8** Collimate the known point A, and press the [F3](ANG) or [F4](DIST) key.  
Example:[F4](DIST)  
Distance measuring starts.

Collimate A  
[F4]

```
HR: 123°40'20"
HD* < m
VD: m
> Measuring...
< complete >
```

Known point B entering display will be shown.

↓

```
NO02#
PT#: _____
INPUT LIST NEZ ENTER
```

**9** Same as procedure **6** to **8** proceed to the known point B.

When two points have been measured by the [F4](DIST) key, the RESIDUAL ERROR will be calculated. \*4)

↓

```
SELECT GRID FACTOR
F1:USE LAST DATA
F2:CALC MEAS.DATA
```

**10** Select GRID FACTOR for calculation of RESIDUAL ERROR by pressing [F1] or [F2] key. \*5)  
Example: [F1]

[F1]

```
RESIDUAL ERROR
dHD= 0.015 m
dZ = 0.005 m
NEXT — G.F CALC
```

**11** Press the [F1](NEXT) key to measure other points.  
Maximum seven points can be measured.

[F1]

```
NO03#
PT#: _____
INPUT LIST NEZ ENTER
```

**12** Same as procedure **6** to **8** proceed to the known point C.

⋮

```
HR: 123°40'20"
HD* < m
VD: m
> Measuring...
< complete >
```

↓

```
HR: 123°40'20"
HD: 123.456 m
VD: 1.234 m
NEXT — — CALC
```

|                                                                                                                                                                                                                                                              |                   |                                                                                                                                                                                                                                                                     |                           |                 |                     |                  |                     |                |                  |                   |
|--------------------------------------------------------------------------------------------------------------------------------------------------------------------------------------------------------------------------------------------------------------|-------------------|---------------------------------------------------------------------------------------------------------------------------------------------------------------------------------------------------------------------------------------------------------------------|---------------------------|-----------------|---------------------|------------------|---------------------|----------------|------------------|-------------------|
| <p><b>13</b> Press the [F4](CALC) key. *6)<br/>Standard Deviation will be shown.<br/>Unit : (sec.) or (mGON) or (mMIL)</p>                                                                                                                                   | <p>[F4]</p>       | <table border="1"> <tr> <td colspan="2"><b>Standard Deviation</b></td> </tr> <tr> <td>=</td> <td><b>1.23 sec.</b></td> </tr> <tr> <td>—</td> <td>↓ — <b>NEZ</b></td> </tr> </table>                                                                                 | <b>Standard Deviation</b> |                 | =                   | <b>1.23 sec.</b> | —                   | ↓ — <b>NEZ</b> |                  |                   |
| <b>Standard Deviation</b>                                                                                                                                                                                                                                    |                   |                                                                                                                                                                                                                                                                     |                           |                 |                     |                  |                     |                |                  |                   |
| =                                                                                                                                                                                                                                                            | <b>1.23 sec.</b>  |                                                                                                                                                                                                                                                                     |                           |                 |                     |                  |                     |                |                  |                   |
| —                                                                                                                                                                                                                                                            | ↓ — <b>NEZ</b>    |                                                                                                                                                                                                                                                                     |                           |                 |                     |                  |                     |                |                  |                   |
| <p><b>14</b> Press the [F2](↓) key.<br/>Standard Deviations of each coordinate will be shown.<br/>Unit : (mm) or (inch)<br/>The display will be changed alternately by pressing [F2](↓) or (↑) key.</p>                                                      | <p>[F2]</p>       | <table border="1"> <tr> <td><b>SD (n) :</b></td> <td><b>1.23 mm</b></td> </tr> <tr> <td><b>SD (e) :</b></td> <td><b>1.23 mm</b></td> </tr> <tr> <td><b>SD (z) :</b></td> <td><b>1.23 mm</b></td> </tr> <tr> <td>—</td> <td>↑ — <b>NEZ</b></td> </tr> </table>       | <b>SD (n) :</b>           | <b>1.23 mm</b>  | <b>SD (e) :</b>     | <b>1.23 mm</b>   | <b>SD (z) :</b>     | <b>1.23 mm</b> | —                | ↑ — <b>NEZ</b>    |
| <b>SD (n) :</b>                                                                                                                                                                                                                                              | <b>1.23 mm</b>    |                                                                                                                                                                                                                                                                     |                           |                 |                     |                  |                     |                |                  |                   |
| <b>SD (e) :</b>                                                                                                                                                                                                                                              | <b>1.23 mm</b>    |                                                                                                                                                                                                                                                                     |                           |                 |                     |                  |                     |                |                  |                   |
| <b>SD (z) :</b>                                                                                                                                                                                                                                              | <b>1.23 mm</b>    |                                                                                                                                                                                                                                                                     |                           |                 |                     |                  |                     |                |                  |                   |
| —                                                                                                                                                                                                                                                            | ↑ — <b>NEZ</b>    |                                                                                                                                                                                                                                                                     |                           |                 |                     |                  |                     |                |                  |                   |
| <p><b>15</b> Press the [F4](NEZ) key.<br/>Coordinate data of the new point will be shown.</p>                                                                                                                                                                | <p>[F4]</p>       | <table border="1"> <tr> <td><b>N :</b></td> <td><b>65.432 m</b></td> </tr> <tr> <td><b>E :</b></td> <td><b>876.543 m</b></td> </tr> <tr> <td><b>Z :</b></td> <td><b>1.234 m</b></td> </tr> <tr> <td><b>&gt;REC ?</b></td> <td><b>[YES] [NO]</b></td> </tr> </table> | <b>N :</b>                | <b>65.432 m</b> | <b>E :</b>          | <b>876.543 m</b> | <b>Z :</b>          | <b>1.234 m</b> | <b>&gt;REC ?</b> | <b>[YES] [NO]</b> |
| <b>N :</b>                                                                                                                                                                                                                                                   | <b>65.432 m</b>   |                                                                                                                                                                                                                                                                     |                           |                 |                     |                  |                     |                |                  |                   |
| <b>E :</b>                                                                                                                                                                                                                                                   | <b>876.543 m</b>  |                                                                                                                                                                                                                                                                     |                           |                 |                     |                  |                     |                |                  |                   |
| <b>Z :</b>                                                                                                                                                                                                                                                   | <b>1.234 m</b>    |                                                                                                                                                                                                                                                                     |                           |                 |                     |                  |                     |                |                  |                   |
| <b>&gt;REC ?</b>                                                                                                                                                                                                                                             | <b>[YES] [NO]</b> |                                                                                                                                                                                                                                                                     |                           |                 |                     |                  |                     |                |                  |                   |
| <p><b>16</b> Press the [F3](YES) key. *7)<br/>The new point data will be stored into the coordinate data file and the value of occupied coordinate data will change to that of the calculated NEW POINT.<br/><br/>The display returns to new point menu.</p> | <p>[F3]</p>       | <table border="1"> <tr> <td colspan="2"><b>NEW POINT</b></td> </tr> <tr> <td colspan="2"><b>F1:SIDE SHOT</b></td> </tr> <tr> <td colspan="2"><b>F2:RESECTION</b></td> </tr> </table>                                                                                | <b>NEW POINT</b>          |                 | <b>F1:SIDE SHOT</b> |                  | <b>F2:RESECTION</b> |                |                  |                   |
| <b>NEW POINT</b>                                                                                                                                                                                                                                             |                   |                                                                                                                                                                                                                                                                     |                           |                 |                     |                  |                     |                |                  |                   |
| <b>F1:SIDE SHOT</b>                                                                                                                                                                                                                                          |                   |                                                                                                                                                                                                                                                                     |                           |                 |                     |                  |                     |                |                  |                   |
| <b>F2:RESECTION</b>                                                                                                                                                                                                                                          |                   |                                                                                                                                                                                                                                                                     |                           |                 |                     |                  |                     |                |                  |                   |

- \*1) Refer to Section 2.6 "How to Enter Alphanumeric characters".
- \*2) When there is no need to memorize the new point data, press the [F3](SKP) key.
- \*3) To enter the known point coordinate data by direct key inputting, press the [F3](NEZ) key.
- \*4) RESIDUAL ERROR;  
dHD (Horizontal distance between two known points) =Measured value – Calculated value  
dZ=(Z coordinate of the new point calculated from known point A) – (Z coordinate of the new point calculated from known point B)
- \*5) [F1:USE LAST DATA]; RESIDUAL ERROR is calculated with GRID FACTOR already set.  
[F2:CALC MEAS.DATA]; RESIDUAL ERROR is calculated without GRID FACTOR already set. In this case, new GRID FACTOR is calculated from measured data and reset."  
•To see the GRID FACTOR value, press the [F3](G.F.) key.
- \*6) In case that the all points are measured by angle measurement only, the following display will be shown.  
You can select Z coordinate calculation.

|                                                                 |
|-----------------------------------------------------------------|
| <p><b>CALC. Z COORD.</b><br/><b>F1:YES</b><br/><b>F2:NO</b></p> |
|-----------------------------------------------------------------|

F1(YES) : :N,E,Z coordinates will be calculated with measured angle data.  
F2(NO) : :N and E coordinates will be calculated with measured horizontal angle data. Z coordinate would not be calculated.  
(Z coordinate value =0.000m)

When the distance measurement is done even one point, Z coordinate will be calculated as a mean value of relative distance (vertical distance data).

\*7) The display shows ">SET ?" when [F3](SKP) key pressed in step 4. In this case, the new point data is not stored into the coordinate data file, only the value of occupied coordinate data changes to that of the calculated NEW POINT.



● **Viewing PT# LIST**

You can see the PT# List and enter the data from the List, also you can see coordinate data of a point.  
 [Example: Executing Layout Mode]

| Operating procedure                                                                                                                                                                                                             | Operation                                          | Display                                                          |
|---------------------------------------------------------------------------------------------------------------------------------------------------------------------------------------------------------------------------------|----------------------------------------------------|------------------------------------------------------------------|
| <p><b>1</b> While executing the LAYOUT mode, press the [F2](LIST) key.<br/>                     The arrow(→) indicates selected data.</p>                                                                                       | <p>[F2]</p>                                        | <pre>LAYOUT PT# : _____ INPUT LIST NEZ ENTER</pre>               |
| <p><b>2</b> By pressing the following keys, the list will increase or decrease.<br/>                     [▲]or[▼]: Increasing or Decreasing one by one.<br/>                     [▶]or[◀] :By ten Increasing or Decreasing.</p> | <p>[▲]or[▼],<br/>                     [▶]or[◀]</p> | <pre>[ TOPCON ] → DATA-01 DATA-02 VIEW SRCH — ENTER</pre>        |
| <p><b>3</b> To show the coordinate of the selected data, press the [F1](VIEW) key.<br/><br/>                     It is still possible to scroll the PT# data by pressing [[▲]or[▼] key.</p>                                     | <p>[F1]</p>                                        | <pre>PT# DATA-50 N] 100.234 m E] 12.345 m Z] 1.678 m</pre>       |
| <p><b>4</b> Press the [ESC] key.<br/>                     The display returns to the List.</p>                                                                                                                                  | <p>[ESC]</p>                                       | <pre>DATA-49 → DATA-50 DATA-51 VIEW SRCH — ENTER</pre>           |
| <p><b>5</b> Press the [F4] (ENTER) key.<br/>                     The selected point number is set as PT#.</p>                                                                                                                   | <p>[F4]</p>                                        | <pre>REFLECTOR HEIGHT INPUT R.HT : 0.000 m INPUT — — ENTER</pre> |
| <p>● The operation of [F2]( SRCH) is same as the "SEARCH" in the MEMORY MANAGER MODE.<br/>                     For more information, refer to Chapter 9 "MEMORY MANAGER MODE".</p>                                              |                                                    |                                                                  |

## 9 MEMORY MANAGER MODE

The following items for internal memory are available in this mode.

- 1) FILE STATUS : Checking the number of stored data / Remaining internal memory capacity.
- 2) SEARCH : Searching the recorded data.
- 3) FILE MAINTAN. : Deleting files / Editing file name
- 4) COORD. INPUT : Inputting coordinate data into Coord. data file.
- 5) DELETE COORD. : Deleting coordinate data from Coord. data file.
- 6) PCODE INPUT : Inputting PCODE DATA into PCODE Library
- 7) DATA TRANSFER : Sending measured data or coordinate data or PCODE Library data / Uploading coordinate data or PCODE Library data / Setting communication parameters
- 8) INITIALIZE : Initializing internal memory.

### ● Memory manager menu operation

By pressing the [MENU] key, the instrument will be in MENU 1/3 mode.

Press the [F3](MEMORY MGR. ) key, the menu of MEMORY MGR. 1/3 will be shown.

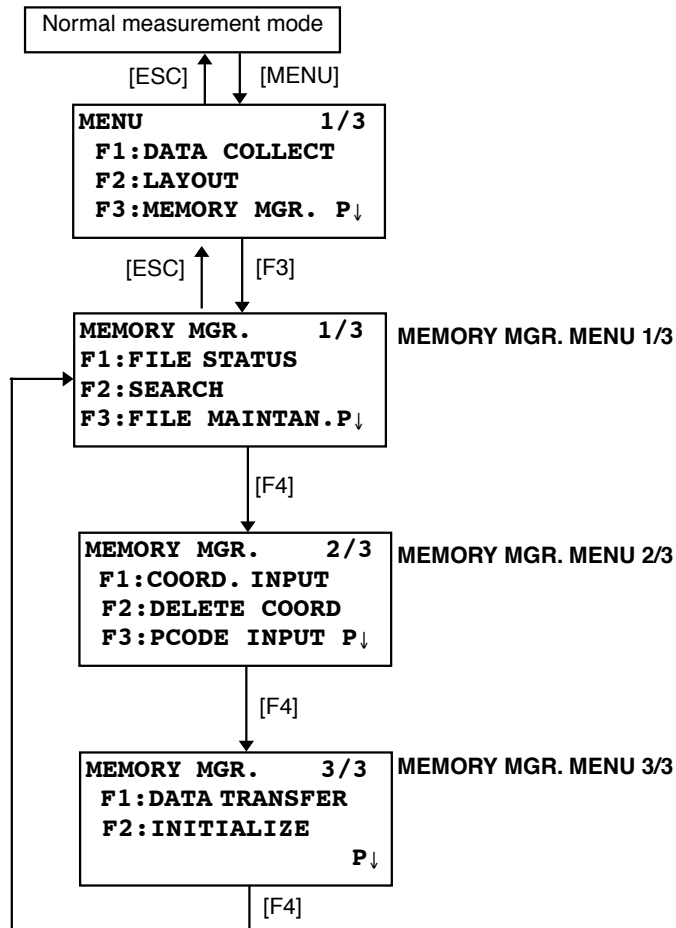

## 9.1 Display Internal Memory Status

This mode is used to check the internal memory status.

| Operating procedure                                                                                                                                                                                                                                                    | Operation | Display                                                                                                                                                                                                                                         |
|------------------------------------------------------------------------------------------------------------------------------------------------------------------------------------------------------------------------------------------------------------------------|-----------|-------------------------------------------------------------------------------------------------------------------------------------------------------------------------------------------------------------------------------------------------|
| <b>1</b> Press the [F3](MEMORY MGR. ) key from the menu 1/3.                                                                                                                                                                                                           | [F3]      | <div style="border: 1px solid black; padding: 5px;"> <b>MEMORY MGR.</b>            1/3<br/> <b>F1:FILE STATUS</b><br/> <b>F2:SEARCH</b><br/> <b>F3:FILE MAINTAN P↓</b> </div>                                                                   |
| <b>2</b> Press the [F1](FILE STATUS) key.<br><br>The total number of stored measured data files and coordinate files are shown.                                                                                                                                        | [F1]      | <div style="border: 1px solid black; padding: 5px;"> <b>FILE STATUS</b>            1/2<br/> <b>MEAS. FILE : 3</b><br/> <b>COORD. FILE: 6</b><br/> <b>[ ..... ] P↓</b> </div> <p style="text-align: center;">↑<br/>Remaining memory capacity</p> |
| <b>3</b> Press the [F4](P↓) key.<br>The total number of stored measured data and coordinate data in all files are shown.*1)                                                                                                                                            | [F4]      | <div style="border: 1px solid black; padding: 5px;"> <b>DATA STATUS</b>            2/2<br/> <b>MEAS. DATA :0100</b><br/> <b>COORD. DATA:0050</b><br/> <b>[ ..... ] P↓</b> </div>                                                                |
| <p>*1) Each coordinate file has one extra data for working area.</p> <ul style="list-style-type: none"> <li>● The FILE/DATA STATUS display will change alternately by pressing [F4]( P↓) key.</li> <li>● To return to MEMORY MGR. menu press the [ESC] key.</li> </ul> |           |                                                                                                                                                                                                                                                 |

## 9.2 Searching Data

This mode is used to search the recorded file data in the DATA COLLECT or LAYOUT mode.

The following 3 search methods in each type of files can be selected.

- 1: First data search
- 2: Last data search
- 3: Point number search(MEAS.DATA, COORD.DATA)  
Number search (PCODE LIB.)

**MEAS. DATA** : Measured data in the data collect mode.

**COORD. DATA** : Coordinate data for layout, control points and new point data measured in the layout mode.

**PCODE LIB.** : The data which was registered with a number from 1 to 50 in Point code library. Point name (PT#, BS#) , ID, PCODE and Height data (INS.HT, R.HT) can be corrected in the searching mode.

Measured value can not be corrected.

### 9.2.1 Measured Data Searching

Example :Point number searching

| Operating procedure                                                                 | Operation                 | Display                                                                                      |
|-------------------------------------------------------------------------------------|---------------------------|----------------------------------------------------------------------------------------------|
| 1 Press the [F3](MEMORY MGR.) key from the menu 1/3.                                | [F3]                      | <pre> MEMORY MGR.      1/3 F1:FILE STATUS F2:SEARCH F3:FILE MAINTAN P↓           </pre>      |
| 2 Press the [F2](SEARCH) key.                                                       | [F2]                      | <pre> SEARCH F1:MEAS. DATA F2:COORD. DATA F3:PCODE LIB.           </pre>                     |
| 3 Press the [F1](MEAS. DATA) key.                                                   | [F1]                      | <pre> SELECT A FILE FN: _____ INPUT LIST  —  ENTER           </pre>                          |
| 4 Press the [F1](INPUT) key and enter File Name.<br>Press the [F4](ENT) key. *1),2) | [F1]<br>Enter FN<br>[F4]  | <pre> MEAS. DATA SEARCH F1:FIRST DATA F2:LAST DATA F3:PT# DATA           </pre>              |
| 5 Press the [F3](PT# DATA) key.                                                     | [F3]                      | <pre> PT# DATA SEARCH PT#: _____ INPUT  —  —  ENTER           </pre>                         |
| 6 Press the [F1](INPUT) key and enter PT#.<br>Press the [F4](ENT) key. *1)          | [F1]<br>Enter PT#<br>[F4] | <pre> PT# TOP-104      2/2 V    98°36'20" HR  160°40'20" TILT   0°00'00"  ↓           </pre> |
| 7 Press the [F4](↓) key to scroll data for selected point.                          | [F4]                      | <pre> PT# TOP-104      1/2 PCODE  R.HT   1.200 m EDIT  ↓           </pre>                    |

\*1) Refer to Section 2.6 "How to enter alphanumeric characters".

\*2) To show the file list, press the [F2](LIST) key.

- " | " represents data shown on the display is the stored data.
- Press the [▲] or [▼] key to scroll to next or previous point.
- To search MEAS. DATA of the same point number, press [◀] or [▶] key.

● **To edit the data in searching mode**

Point name (PT#, BS#) , ID, PCODE and Height data (INS.HT, R.HT) can be corrected in the searching mode.

Measured value can not be corrected.

| Operating procedure                                                                                                                                                                                                                                                                                                                           | Operation                          | Display                                                           |
|-----------------------------------------------------------------------------------------------------------------------------------------------------------------------------------------------------------------------------------------------------------------------------------------------------------------------------------------------|------------------------------------|-------------------------------------------------------------------|
| <p><b>1</b> Press the [F1](EDIT) key from last page of displayed data.</p> <p><b>2</b> Select the item to correct by pressing [<b>▲</b>]or[<b>▼</b>] key.</p> <p><b>3</b> Press the [F1](INPUT) key and enter data. *1)<br/>Press the [F4](ENT) key.</p> <p><b>4</b> Press the [F4](ENTER) key.</p> <p><b>5</b> Press the [F3](YES) key .</p> | [F1]                               | <pre>PT# TOP-104      2/2 PCODE  R.HT       1.000 m EDIT  ↓</pre> |
|                                                                                                                                                                                                                                                                                                                                               |                                    | [ <b>▲</b> ]or[ <b>▼</b> ]                                        |
|                                                                                                                                                                                                                                                                                                                                               | [F1]<br>Enter Data<br>[F4]<br>[F4] |                                                                   |
|                                                                                                                                                                                                                                                                                                                                               |                                    | [F1]<br>Enter Data<br>[F4]<br>[F4]                                |
|                                                                                                                                                                                                                                                                                                                                               | [F3]                               |                                                                   |
| <p>*1) Refer to Section 2.6 “How to Enter Alphanumeric characters”.</p> <ul style="list-style-type: none"> <li>● When editing, ID and PCODE are not linked with PCODE LIBRARY.</li> <li>● Even though the height data (INS.HT, R.HT) are corrected, the measured value can not be corrected.</li> </ul>                                       |                                    |                                                                   |

## 9.2.2 Coordinate Data Searching

Example searching :Point number searching

| Operating procedure                                                                                                                                                                                                                                                                                                                                  | Operation                 | Display                                                                                  |
|------------------------------------------------------------------------------------------------------------------------------------------------------------------------------------------------------------------------------------------------------------------------------------------------------------------------------------------------------|---------------------------|------------------------------------------------------------------------------------------|
| 1 Press the [F3](MEMORY MGR.) key from the menu 1/3.                                                                                                                                                                                                                                                                                                 | [F3]                      | <pre> MEMORY MGR.      1/3 F1:FILE STATUS F2:SEARCH F3:FILE MAINTAN  P↓           </pre> |
| 2 Press the [F2](SEARCH) key.                                                                                                                                                                                                                                                                                                                        | [F2]                      | <pre> SEARCH F1:MEAS. DATA F2:COORD. DATA F3:PCODE LIB.           </pre>                 |
| 3 Press the [F2](COORD. DATA) key.                                                                                                                                                                                                                                                                                                                   | [F2]                      | <pre> SELECT A FILE FN: _____  INPUT LIST  —  ENTER           </pre>                     |
| 4 Press the [F1](INPUT) key and enter File Name.<br>Press the [F4](ENT) key. *1)                                                                                                                                                                                                                                                                     | [F1]<br>Enter FN<br>[F4]  | <pre> COORD. DATA SEARCH F1:FIRST DATA F2:LAST DATA F3:PT# DATA           </pre>         |
| 5 Press the [F3](PT# DATA) key.                                                                                                                                                                                                                                                                                                                      | [F3]                      | <pre> PT# DATA SEARCH PT#: _____  INPUT  —  —  ENTER           </pre>                    |
| 6 Press the [F1](INPUT) key and enter PT#.<br>Press the [F4](ENT) key. *1)                                                                                                                                                                                                                                                                           | [F1]<br>Enter PT#<br>[F4] | <pre> PT# TOP-104 N   100.234 m E   12.345 m Z   1.678 m           </pre>                |
| <p>*1) Refer to Section 2.6 "How to Enter Alphanumeric characters".</p> <ul style="list-style-type: none"> <li>● "j" represents data shown on the display is the stored data.</li> <li>● Press the [▲] or [▼] key to scroll to next or previous point.</li> <li>● To search COORD. DATA of the same point number, press the [◀]or[▶] key.</li> </ul> |                           |                                                                                          |

### 9.2.3 PCODE LIBRARY Searching

Example searching :Number searching

| Operating procedure                                                                                                                                                                                                                                                         | Operation                 | Display                                                                                                                  |
|-----------------------------------------------------------------------------------------------------------------------------------------------------------------------------------------------------------------------------------------------------------------------------|---------------------------|--------------------------------------------------------------------------------------------------------------------------|
| <b>1</b> Press the [F3](MEMORY MGR.) key from the menu 1/3.                                                                                                                                                                                                                 | [F3]                      | <pre> <b>MEMORY MGR.</b>          1/3 <b>F1:FILE STATUS</b> <b>F2:SEARCH</b> <b>F3:FILE MAINTAN</b>  P↓           </pre> |
| <b>2</b> Press the [F2](SEARCH) key.                                                                                                                                                                                                                                        | [F2]                      | <pre> <b>SEARCH</b> <b>F1:MEAS. DATA</b> <b>F2:COORD. DATA</b> <b>F3:PCODE LIB.</b>           </pre>                     |
| <b>3</b> Press the [F3](PCODE LIB.) key.                                                                                                                                                                                                                                    | [F3]                      | <pre> <b>PCODE DATA SEARCH</b> <b>F1:FIRST DATA</b> <b>F2:LAST DATA</b> <b>F3:No. SEARCH</b>           </pre>            |
| <b>4</b> Press the [F3](No. SEARCH) key.                                                                                                                                                                                                                                    | [F3]                      | <pre> <b>PCODE No. SEARCH</b> <b>No. :</b> <b>INPUT  —  —  ENTER</b>           </pre>                                    |
| <b>5</b> Press the [F1](INPUT) key and enter number.Press the [F4](ENT) key. *1)<br><br>The number and linked data will be shown. *2)                                                                                                                                       | [F1]<br>Enter PT#<br>[F4] | <pre> <b>011:NAKADAI</b> <b>→012:HILLTOP</b> <b>013:ITABASH</b> <b>EDIT  —  CLR  —</b>           </pre>                  |
| <p>*1) Refer to Section 2.6 “How to Enter Alphanumeric characters”.</p> <p>● Press the [▲] or [▼] key to scroll to next or previous PCODE data.</p> <p>*2) To correct the PCODE data , press the [F1](EDIT) key.<br/>To delete the PCODE data, press the [F3](CLR) key.</p> |                           |                                                                                                                          |

### 9.3 FILE MAINTENANCE

In this mode, the following items are available.

Renaming file name / Searching data in a file / Deleting files

● **FILE MAINTAN.** menu

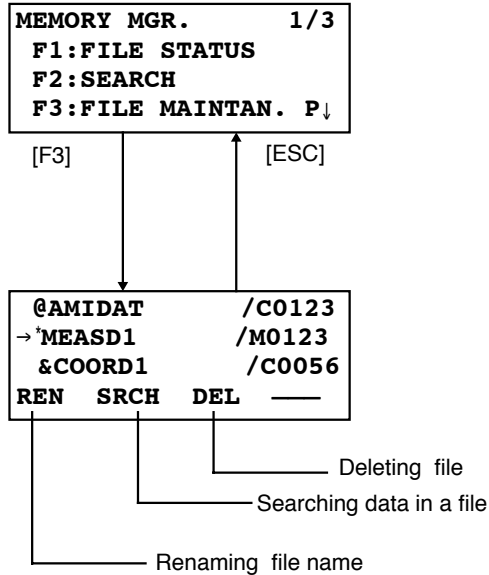

Pressing [F3](FILE MAINTAN.) key from MEMORY MANAGER menu 1/3, file list will be shown.

- File discrimination mark (\*,@,&)  
File discrimination mark (\*,@,&) placed before file name indicates the file status.  
For measured data file  
" \* " :selected file for DATA COLLECT mode.  
For coordinate data file  
" \* " :selected coordinate file for LAYOUT mode.  
" @ " :selected coordinate file for DATA COLLECT mode.  
" & " :selected coordinate file for both LAYOUT and DATA COLLECT mode.
- Data discrimination character (M, C)  
Data discrimination character (M, C) placed before four figures indicates the type of data.  
" M " :Measured data  
" C " :Coordinate data.
- Four figures means the total number of data in the file.  
(Coordinate data file has an extra data for working.)  
Press the [▲] or [▼] key to scroll to next file.



### 9.3.1 Rename a File

An existing file in internal memory can be renamed.

| Operating procedure                                                                                                                                                                 | Operation        | Display                                                                                            |
|-------------------------------------------------------------------------------------------------------------------------------------------------------------------------------------|------------------|----------------------------------------------------------------------------------------------------|
| <b>1</b> Press the [F3](FILE MAINTAN.) key from the Memory manager menu 1/3.                                                                                                        | [F3]             | <pre> →MEASD1      /M0123   COORD1      /C0056 REN  SRCH  DEL  — </pre>                            |
| <b>2</b> Select a file by pressing [▲]or[▼] key.                                                                                                                                    | [▲]or[▼]         | <pre>   MEASD1      /M0123 →COORD1      /C0056   COORD2      /C0098 REN  SRCH  DEL  — </pre>       |
| <b>3</b> Press the [F1](REN) key.                                                                                                                                                   | [F1]             | <pre>   MEASD1      /M0123 =COORD1      /C0056   COORD1      /C0098 [ALP] [SPC] [CLR] [ENT] </pre> |
| <b>4</b> Enter new file name.<br>Press the [F4](ENT) key. *1)                                                                                                                       | Enter FN<br>[F4] | <pre>   MEASD1      /M0123 →COORD5      /C0056   COORD1      /C0098 REN  SRCH  DEL  — </pre>       |
| <p>*1) Refer to Section 2.6 "How to Enter Alphanumeric characters".<br/>Existing file name can not be available.<br/>To return to the FILE MAINTAN. Menu , press the [ESC] key.</p> |                  |                                                                                                    |

### 9.3.2 Searching Data in a File

An existing file in internal memory can be searched.

| Operating procedure                                                                                                                                                                                  | Operation    | Display                                                                                      |
|------------------------------------------------------------------------------------------------------------------------------------------------------------------------------------------------------|--------------|----------------------------------------------------------------------------------------------|
| <b>1</b> Press the [F3](FILE MAINTAN.) key from the Memory manager menu 1/3.                                                                                                                         | [F3]         | <pre> →MEASD1      /M0123   COORD1      /C0056 REN  SRCH  DEL  — </pre>                      |
| <b>2</b> Select a file to search by pressing [▲]or[▼] key.                                                                                                                                           | [▲]or[▼]     | <pre>   MEASD1      /M0123 →COORD1      /C0056   COORD2      /C0098 REN  SRCH  DEL  — </pre> |
| <b>3</b> Press the [F2](SRCH) key.                                                                                                                                                                   | [F2]         | <pre> SEARCH      [COORD1 ] F1:FIRST DATA F2:LAST DATA F3:PT# DATA </pre>                    |
| <b>4</b> Select searching method by pressing the [F1] to [F3] key. *1)                                                                                                                               | [F1] to [F3] |                                                                                              |
| <p>*1) Because procedures from next are same as procedures of Section 9.2 "Searching Data", refer to Section 9.2 "Searching Data"<br/>To return to the FILE MAINTAN. Menu , press the [ESC] key.</p> |              |                                                                                              |

### 9.3.3 Deleting a File

This mode erases a file from internal memory. Only one file can be erased at a time.

| Operating procedure                                                          | Operation  | Display                                                                                              |
|------------------------------------------------------------------------------|------------|------------------------------------------------------------------------------------------------------|
| <b>1</b> Press the [F3](FILE MAINTAN.) key from the Memory manager menu 1/3. | [F3]       | <pre> →MEASD1      /M0123   COORD1      /C0056 REN  SRCH  DEL  — </pre>                              |
| <b>2</b> Select a file to delete by pressing [▲] or [▼] key.                 | [▲] or [▼] | <pre>   MEASD1      /M0123 →COORD1      /C0056   COORD2      /C0098 REN  SRCH  DEL  — </pre>         |
| <b>3</b> Press the [F3](DEL) key.                                            | [F3]       | <pre>   MEASD1      /M0123 →COORD1      /C0056   COORD2      /C0098 &gt;DELETE?    [NO] [YES] </pre> |
| <b>4</b> Confirm the deleting, and press the [F4](YES) key.                  | [F4]       | <pre>   MEASD1      /M0123 →COORD2      /C0098   COORD3      /C0321 REN  SRCH  DEL  — </pre>         |
| <p>● To return to the FILE MAINTAN. Menu , press the [ESC] key.</p>          |            |                                                                                                      |

## 9.4 Coordinate Data Direct Key Input

Coordinate data for the layout point or control point can be input directly from the keyboard. This data can be stored into a file in the internal memory.

| Operating procedure                                                                                                                  | Operation                    | Display                                                                                                                            |
|--------------------------------------------------------------------------------------------------------------------------------------|------------------------------|------------------------------------------------------------------------------------------------------------------------------------|
| <b>1</b> Press the [F3](MEMORY MGR.) key from the menu 1/3.                                                                          | [F3]                         | <pre> <b>MEMORY MGR.</b>          1 / 3 <b>F1:FILE STATUS</b> <b>F2:SEARCH</b> <b>F3:FILE MAINTAN</b>  P↓           </pre>         |
| <b>2</b> Press the [F4](P↓) key.                                                                                                     | [F4]                         | <pre> <b>MEMORY MGR.</b>          2 / 3 <b>F1:COORD. INPUT</b> <b>F2:DELETE COORD.</b> <b>F3:PCODE INPUT</b>   P↓           </pre> |
| <b>3</b> Press the [F1](COORD. INPUT) key.                                                                                           | [F1]                         | <pre> <b>SELECT A FILE</b> <b>FN: _____</b> <b>INPUT LIST  —  ENTER</b>           </pre>                                           |
| <b>4</b> Press the [F1](INPUT) key and enter File Name you want to input.<br>Press the [F4](ENT) key. *1)                            | [F1]<br>Enter FN<br>[F4]     | <pre> <b>COORD. DATA INPUT</b> <b>PT#: _____</b> <b>INPUT LIST  —  ENTER</b>           </pre>                                      |
| <b>5</b> Press the [F1](INPUT) key and enter PT#. Press the [F4](ENT) key. *1)                                                       | [F1]<br>Enter PT#<br>[F4]    | <pre> <b>N→</b>                m <b>E:</b>                m <b>Z:</b>                m <b>INPUT  —  —  ENTER</b>           </pre>  |
| <b>6</b> Enter coordinate data in the same way.<br><br>Next input display is shown, point number (PT#) is automatically incremented. | [F1]<br>Enter COORD.<br>[F4] | <pre> <b>COORD. DATA INPUT</b> <b>PT#:TOPCON-102</b> <b>INPUT LIST  —  ENTER</b>           </pre>                                  |
| *1) Refer to Section 2.6 "How to Enter Alphanumeric characters".                                                                     |                              |                                                                                                                                    |

## 9.5 Delete a Coordinate Data from a File

Coordinate data in a file can be erased.

| Operating procedure                                                                                                            | Operation                 | Display                                                                                                                           |
|--------------------------------------------------------------------------------------------------------------------------------|---------------------------|-----------------------------------------------------------------------------------------------------------------------------------|
| <b>1</b> Press the [F3](MEMORY MGR.) key from the menu 1/3.                                                                    | [F3]                      | <pre> <b>MEMORY MGR.</b>          1/3 <b>F1:FILE STATUS</b> <b>F2:SEARCH</b> <b>F3:FILE MAINTAN</b>  P↓           </pre>          |
| <b>2</b> Press the [F4](P↓) key.                                                                                               | [F4]                      | <pre> <b>MEMORY MGR.</b>          2/3 <b>F1:COORD. INPUT</b> <b>F2:DELETE COORD.</b> <b>F3:PCODE INPUT</b>    P↓           </pre> |
| <b>3</b> Press the [F2](DELETE COORD.) key.                                                                                    | [F2]                      | <pre> <b>SELECT A FILE</b> <b>FN: _____</b> <b>INPUT LIST  —  ENTER</b>           </pre>                                          |
| <b>4</b> Press the [F1](INPUT) key and enter File Name.<br>Press the [F4](ENT) key. *1)                                        | [F1]<br>Enter FN<br>[F4]  | <pre> <b>DELETE COORD.</b> <b>PT#: _____</b> <b>INPUT LIST  —  ENTER</b>           </pre>                                         |
| <b>5</b> Press the [F1](INPUT) key and enter PT#.<br>Press the [F4](ENT) key. *1)                                              | [F1]<br>Enter PT#<br>[F4] | <pre> <b>N:    100.234 m</b> <b>E:    12.345 m</b> <b>Z:    1.678 m</b> <b>&gt;DELETE?  [YES] [NO]</b>           </pre>           |
| <b>6</b> Confirm the data and press the [F3](YES) key.<br>Deleting starts.<br>The display will return to the previous display. | [F3]                      |                                                                                                                                   |
| *1) Refer to Section 2.6 "How to Enter Alphanumeric characters".                                                               |                           |                                                                                                                                   |

## 9.6 Editing PCODE Library

PCODE data can be entered into PCODE Library in this mode.

A PCODE is linked with a number of 1 to 50

PCODE can be also edited in DATA COLLECT menu 2/3 in the same way.

| Operating procedure                                                                                                                                                         | Operation             | Display                                                                                                                            |
|-----------------------------------------------------------------------------------------------------------------------------------------------------------------------------|-----------------------|------------------------------------------------------------------------------------------------------------------------------------|
| <b>1</b> Press the [F3](MEMORY MGR. ) key from the menu 1/3.                                                                                                                | [F3]                  | <pre> <b>MEMORY MGR.</b>          1 / 3 <b>F1:FILE STATUS</b> <b>F2:SEARCH</b> <b>F3:FILE MAINTAN.</b> P↓           </pre>         |
| <b>2</b> Press the [F4](P↓) key.                                                                                                                                            | [F4]                  | <pre> <b>MEMORY MGR.</b>          2 / 3 <b>F1:COORD. INPUT</b> <b>F2:DELETE COORD.</b> <b>F3:PCODE INPUT</b>   P↓           </pre> |
| <b>3</b> Press the [F3](PCODE INPUT) key.                                                                                                                                   | [F3]                  | <pre> →001:TOPCON   002:TOKYO <b>EDIT</b>  ———  <b>CLR</b>  ———           </pre>                                                   |
| <b>4</b> By pressing the following keys, the list will increase or decrease.<br>[▲]or[▼] :Increasing or Decreasing one by one<br>[▶]or[◀] :By ten Increasing or Decreasing. | [▲]or[▼],<br>[▶]or[◀] | <pre>   011:URAH → 012:AMIDAT   013:HILLTO <b>EDIT</b>  ———  <b>CLR</b>  ———           </pre>                                      |
| <b>5</b> Press the [F1](EDIT) key.                                                                                                                                          | [F1]                  | <pre>   011:URAH → 012=AMIDAT   013:HILLTO [ALP] [SPC] [CLR] [ENT]           </pre>                                                |
| <b>6</b> Enter PCODE and press the [F4](ENT) key. *1)                                                                                                                       | Enter PCODE<br>[F4]   | <pre>   011:URAH → 012:AMISUN   013:HILLTO <b>EDIT</b>  ———  <b>CLR</b>  ———           </pre>                                      |
| *1) Refer to Section 2.6 “How to Enter Alphanumeric characters”.                                                                                                            |                       |                                                                                                                                    |

## 9.7 Data Communications

You can send a data file stored in the internal memory to a computer directly. Also, you can directly load a coordinate data file and PCODE Library data to the internal memory from the computer.

### 9.7.1 Sending Data

Example: Sending a Measured data file

| Operating procedure                                                                                                                                                                                                                                    | Operation                | Display                                                                                                        |
|--------------------------------------------------------------------------------------------------------------------------------------------------------------------------------------------------------------------------------------------------------|--------------------------|----------------------------------------------------------------------------------------------------------------|
| <b>1</b> Press the [F3](MEMORY MGR.) key from the menu 1/3.                                                                                                                                                                                            | [F3]                     | <pre> MEMORY MGR.      1 / 3 F1:FILE STATUS F2:SEARCH F3:FILE MAINTAN  P↓           </pre>                     |
| <b>2</b> Press the [F4](P↓) key twice.                                                                                                                                                                                                                 | [F4]<br>[F4]             | <pre> MEMORY MGR.      3 / 3 F1:DATA TRANSFER F2:INITIALIZE                                P↓           </pre> |
| <b>3</b> Press the [F1](DATA TRANSFER) key .                                                                                                                                                                                                           | [F1]                     | <pre> DATA TRANSFER F1:SEND DATA F2:LOAD DATA F3:COMM. PARAMETERS           </pre>                             |
| <b>4</b> Press the [F1] key.                                                                                                                                                                                                                           | [F1]                     | <pre> SEND DATA F1:MEAS.  DATA F2:COORD. DATA F3:PCODE  DATA           </pre>                                  |
| <b>5</b> Select the type of data to send by pressing [F1]-[F3] key.<br>Example : [F1](MEAS. DATA)                                                                                                                                                      | [F1]                     | <pre> SELECT A FILE FN: _____ INPUT LIST  —  ENTER           </pre>                                            |
| <b>6</b> Press the [F1](INPUT) key and enter File Name you want to send. Press the [F4](ENT) key. *1),2)                                                                                                                                               | [F1]<br>Enter FN<br>[F4] | <pre> SEND MEAS. DATA &gt;OK ? —  —  [ YES ] [ NO ]           </pre>                                           |
| <b>7</b> Press the [F3](YES) key .*3)<br>The sending starts.<br>The display will return to menu.                                                                                                                                                       | [F3]                     | <pre> SEND MEAS. DATA &lt; Sending Data! &gt;                 STOP           </pre>                            |
| <p>*1) Refer to Section 2.6 “How to Enter Alphanumeric characters”.</p> <p>*2) To scroll the data, press the [▲] or [▼] key.</p> <p>● To show the file list, press the [F2](LIST) key.</p> <p>*3) To cancel the sending, press the [F4](STOP) key.</p> |                          |                                                                                                                |

## 9.7.2 Loading Data

Coordinate data files and PCODE Library data can be loaded from PC.

Example: Loading a coordinate data file

| Operating procedure                                                                                                                 | Operation                | Display                                                                                                                                       |
|-------------------------------------------------------------------------------------------------------------------------------------|--------------------------|-----------------------------------------------------------------------------------------------------------------------------------------------|
| <b>1</b> Press the [F3](MEMORY MGR.) key from the menu 1/3.                                                                         | [F3]                     | <pre> <b>MEMORY MGR.</b>          1 / 3 <b>F1:FILE STATUS</b> <b>F2:SEARCH</b> <b>F3:FILE MAINTAN</b>  P↓           </pre>                    |
| <b>2</b> Press the [F4](P↓) key twice.                                                                                              | [F4]<br>[F4]             | <pre> <b>MEMORY MGR.</b>          3 / 3 <b>F1:DATA TRANSFER</b> <b>F2:INITIALIZE</b>                                      P↓           </pre> |
| <b>3</b> Press the [F1](DATA TRANSFER) key .                                                                                        | [F1]                     | <pre> <b>DATA TRANSFER</b> <b>F1:SEND DATA</b> <b>F2:LOAD DATA</b> <b>F3:COMM. PARAMETERS</b>           </pre>                                |
| <b>4</b> Press the [F2] key.                                                                                                        | [F2]                     | <pre> <b>LOAD DATA</b> <b>F1:COORD. DATA</b> <b>F2:PCODE DATA</b>           </pre>                                                            |
| <b>5</b> Select the type of data to load by pressing [F1] or [F2] key.<br>Example : [F1](COORD. DATA)                               | [F1]                     | <pre> <b>COORD. FILE NAME</b> <b>FN: _____</b> <b>INPUT  —  —  ENTER</b>           </pre>                                                     |
| <b>6</b> Press the [F1](INPUT) key and enter New File Name you want to receive. Press the [F4](ENT) key. *1)                        | [F1]<br>Enter FN<br>[F4] | <pre> <b>LOAD COORD. DATA</b> <b>&gt;OK ?</b> <b>—  —  [YES] [NO]</b>           </pre>                                                        |
| <b>7</b> Press the [F3](YES) key.*2)<br>The loading starts.<br>The display will return to menu.                                     | [F3]                     | <pre> <b>LOAD COORD. DATA</b> <br/> <b>&lt; Loading Data!&gt;</b> <b>STOP</b>           </pre>                                                |
| <p>*1) Refer to Section 2.6 "How to Enter Alphanumeric characters".</p> <p>*2) To cancel the loading, press the [F4](STOP) key.</p> |                          |                                                                                                                                               |

### 9.7.3 Setting Parameter of Data Communications

#### ● Items of the Parameter

| Item               | Selecting Item                         | Contents                                                                  |
|--------------------|----------------------------------------|---------------------------------------------------------------------------|
| F1: Protocol       | [ACK/NAK],<br>[ONE WAY]                | Setting Protocol<br>[ACK/NAK] or [ONE WAY] communication                  |
| F2: Baud rate      | 1200, 2400, 4800,<br>9600, 19200,38400 | Setting transfer speed<br>1200/2400/4800/9600 /19200/ 38400 baud rate     |
| F3: Char. / Parity | [7/EVEN], [7/ODD],<br>[8/NON]          | Setting data length and parity.<br>[7bit, even], [7bit, odd], [8bit,none] |
| F1: Stop Bits      | 1, 2                                   | Setting Stop 1 bit or 2bits                                               |

#### ● Example Setting Baud rate : 4800

| Operating procedure                                                | Operation    | Display                                                                                                                                 |
|--------------------------------------------------------------------|--------------|-----------------------------------------------------------------------------------------------------------------------------------------|
| 1 Press the [F3](MEMORY MGR.) key from the menu 1/3.               | [F3]         | <pre> <b>MEMORY MGR.</b>      1/3 <b>F1:FILE STATUS</b> <b>F2:SEARCH</b> <b>F3:FILE MAINTAN</b> P↓           </pre>                     |
| 2 Press the [F4](P↓) key twice.                                    | [F4]<br>[F4] | <pre> <b>MEMORY MGR.</b>      3/3 <b>F1:DATA TRANSFER</b> <b>F2:INITIALIZE</b>                                      P↓           </pre> |
| 3 Press the [F1](DATA TRANSFER) key .                              | [F1]         | <pre> <b>DATA TRANSFER</b> <b>F1:SEND DATA</b> <b>F2:LOAD DATA</b> <b>F3:COMM. PARAMETERS</b>           </pre>                          |
| 4 Press the [F3](COMM. PARAMETERS) key.                            | [F3]         | <pre> <b>COMM. PARAMETERS</b> 1/2 <b>F1:PROTOCOL</b> <b>F2:BAUD RATE</b> <b>F3:CHAR./PARITY</b> P↓           </pre>                     |
| 5 Press the [F2](BAUD RATE) key.<br>[ ] indicates present setting. | [F2]         | <pre> <b>BAUD RATE</b> [1200] 2400   4800           9600 19200 38400                                      ENTER           </pre>        |
| 6 Select the items by pressing [▲]or[▼], [◀] and [▶] keys. *1)     | [▶]<br>[▼]   | <pre> <b>BAUD RATE</b>  1200  2400  [4800]  9600 19200 38400                                      ENTER           </pre>                |
| 7 Press the [F4](ENTER) key.                                       | [F4]         | <pre> <b>COMM. PARAMETERS</b> 1/2 <b>F1:PROTOCOL</b> <b>F2:BAUD RATE</b> <b>F3:CHAR./PARITY</b> P↓           </pre>                     |

\*1) To cancel setting, press the [ESC] key.



## 9.8 Initialization

This mode is used to initialize the internal memory.

Following data can be initialized.

FILE DATA :All files of measuring data and coordinate data

PCODE DATA: PCODE LIST

ALL DATA: FILE DATA and PCODE DATA

Note that the following data are not initialized even if initialization is executed.

: Coordinates of the instrument, Instrument height and Reflector height.

Example Initialization: ALL DATA ( FILE data and PCODE data)

| Operating procedure                                                                                                       | Operation    | Display                                                                                                                                                                                   |
|---------------------------------------------------------------------------------------------------------------------------|--------------|-------------------------------------------------------------------------------------------------------------------------------------------------------------------------------------------|
| <b>1</b> Press the [F3](MEMORY MGR.) key from the menu 1/3.                                                               | [F3]         | <pre> <b>MEMORY MGR.</b>          1 / 3 <b>F1:FILE STATUS</b> <b>F2:SEARCH</b> <b>F3:FILE MAINTAN.</b> P↓           </pre>                                                                |
| <b>2</b> Press the [F4](P↓) key twice.                                                                                    | [F4]<br>[F4] | <pre> <b>MEMORY MGR.</b>          3 / 3 <b>F1:DATA TRANSFER</b> <b>F2:INITIALIZE</b>                                P↓           </pre>                                                   |
| <b>3</b> Press the [F2](INITIALIZE) key.                                                                                  | [F2]         | <pre> <b>INITIALIZE</b> <b>F1:FILE AREA</b> <b>F2:PCODE LIST</b> <b>F3:ALL DATA</b>           </pre>                                                                                      |
| <b>4</b> Select the data to initialize by pressing one of the [F1] to [F3] key.<br>Example : [F3](ALL DATA)               | [F3]         | <pre> <b>INITIALIZE DATA</b> <b>ERASE ALL DATA !</b>  &gt;OK ?      [NO] [YES]           </pre>                                                                                           |
| <b>5</b> Confirm the erase data, press the [F4](YES) key.<br>Initializing will start.<br><br>The display returns to menu. | [F4]         | <pre> <b>INITIALIZE DATA</b>  &lt;Initializing!&gt;  ↓  <b>MEMORY MGR.</b>          3 / 3 <b>F1:DATA TRANSFER</b> <b>F2:INITIALIZE</b>                                P↓           </pre> |

## 10 SET AUDIO MODE

The light acceptance quantity level for the EDM (SIGNAL), the atmospheric correction value (PPM) and correction value of prism constant (PSM) are displayed in this mode.

When reflected light from the prism is received a buzzer sounds. This function is good for easy collimation when the target is difficult to find.

| Operating procedure                                                                                                                                                                                                                                                                                                                            | Operation | Display                                                                                                                                                                                                                                                                                                                                                                  |
|------------------------------------------------------------------------------------------------------------------------------------------------------------------------------------------------------------------------------------------------------------------------------------------------------------------------------------------------|-----------|--------------------------------------------------------------------------------------------------------------------------------------------------------------------------------------------------------------------------------------------------------------------------------------------------------------------------------------------------------------------------|
| <p><b>1</b> Make sure the mode is in the distance measurement mode on page 1.</p> <p><b>2</b> Pressing the [F3](S/A) key, mode changes to set audio mode.</p> <p>The display indicates correction value of prism constant (PSM), atmospheric correction (PPM) and reflection light level (SIGNAL).</p>                                         | [F3]      | <div style="border: 1px solid black; padding: 5px; margin-bottom: 5px;"> <p><b>HR: 120°30'40"</b><br/> <b>HD* 123.456 m</b><br/> <b>VD: 5.678 m</b><br/> <b>MEAS MODE S/A P1↓</b></p> </div> <div style="border: 1px solid black; padding: 5px;"> <p><b>SET AUDIO MODE</b><br/> <b>PSM:0.0 PPM 0.0</b><br/> <b>SIGNAL: [    ]</b><br/> <b>PRISM PPM T-P —</b></p> </div> |
| <ul style="list-style-type: none"> <li>● When receiving reflected light, buzzer sounds.<br/>It is possible to stop the sound, see Chapter 16 "SELECTING MODE".</li> <li>● The [F1] to [F3] keys are used for setting atmospheric correction and prism constant.</li> <li>● To return to normal measuring mode, press the [ESC] key.</li> </ul> |           |                                                                                                                                                                                                                                                                                                                                                                          |

# 11 SETTING THE PRISM CONSTANT VALUE

The prism constant value of Topcon is set to zero. When using prisms other than Topcon's, it is necessary to set the prism constant correction value of that specific prism.

Once you set the correction value for prism constant, it is retained after power is OFF.

| Operating procedure                                                                                               | Operation                  | Display                                                                                                                  |
|-------------------------------------------------------------------------------------------------------------------|----------------------------|--------------------------------------------------------------------------------------------------------------------------|
| <b>1</b> Press the [F3](S/A) key from distance measurement or coordinates measurement mode.                       | [F3]                       | <pre> <b>SET AUDIO MODE</b> <b>PSM:0.0   PPM   0.0</b> <b>SIGNAL: [     ]</b> <b>PRISM PPM  T-P  —</b>           </pre>  |
| <b>2</b> Press the [F1](PRISM) key.                                                                               | [F1]                       | <pre> <b>PRISM CONST. SET</b> <b>PRISM :0.0 mm</b>  <b>INPUT — — ENTER</b>           </pre>                              |
| <b>3</b> Input the Prism constant correction value. *1)<br>The display returns to set audio mode.                 | [F1]<br>Enter data<br>[F4] | <pre> <b>SET AUDIO MODE</b> <b>PSM:14.0   PPM   0.0</b> <b>SIGNAL: [     ]</b> <b>PRISM PPM  T-P  —</b>           </pre> |
| *1) Refer to Section 2.6 "How to Enter Alphanumeric characters".<br>● Input range : -99.9mm to +99.9mm,0.1mm step |                            |                                                                                                                          |

# 12 SETTING ATMOSPHERIC CORRECTION

The velocity of light through air is not constant and depends on the atmospheric temperature and pressure. The atmospheric correction system of this instrument corrects automatically when the correction value is set. 15°C/59°F, and 1013.25hPa / 760mmHg / 29.9 inHg is as a standard value for 0ppm in this instrument. The values are kept in the memory even after power is OFF.

## 12.1 Calculation of Atmospheric Correction

The followings are the correction formulas.

Unit; meter

$$Ka = \left\{ 279.67 - \frac{79.535 \times P}{273.15 + t} \right\} \times 10^{-6}$$

*Ka*: Atmospheric correction value  
*P* : Ambient atmospheric pressure (hPa)  
*t* : Ambient Atmospheric temperature (°C)

The distance L (m) after atmospheric correction is obtained as follow.

$$L = l(1+Ka)$$

*l*: Measured distance when atmospheric correction is not set.

Example : In case Temperature +20°C, Air pressure 847hPa, l=1000 m

$$Ka = \left\{ 279.67 - \frac{79.535 \times 847}{273.15 + 20} \right\} \times 10^{-6}$$

$$\approx +50 \times 10^{-6} \text{ (50 ppm)}$$

$$L = 1000 (1+50 \times 10^{-6}) = 1000.050 \text{ m}$$

## 12.2 Setting of Atmospheric Correction Value

### ● How to Set Temperature and Pressure Value Directly

Measure the temperature and air pressure surrounding the instrument beforehand.

Example : Temperature: +26°C, Pressure:1017 hPa

| Operating procedure                                                                                  | Operation                  | Display                                                                                                                                                                                |
|------------------------------------------------------------------------------------------------------|----------------------------|----------------------------------------------------------------------------------------------------------------------------------------------------------------------------------------|
| <b>1</b> Press the [F3](S/A) key to set Set Audio Mode from distance or coordinate measurement mode. | [F3]                       | <div style="border: 1px solid black; padding: 5px;"> <p><b>SET AUDIO MODE</b><br/> <b>PSM:0.0 PPM 0.0</b><br/> <b>SIGNAL:[    ]</b><br/> <b>PRISM PPM T-P —</b></p> </div>             |
| <b>2</b> Press the [F3](T-P) key.                                                                    | [F3]                       | <div style="border: 1px solid black; padding: 5px;"> <p><b>TEMP. &amp; PRES. SET</b><br/> <b>TEMP. → 15.0 °C</b><br/> <b>PRES. : 1013.2 hPa</b><br/> <b>INPUT — — ENTER</b></p> </div> |
| <b>3</b> Input Temp.value and Pressure value.*1)<br>Mode returns to Set Audio mode.                  | Enter Temp.<br>Enter Pres. | <div style="border: 1px solid black; padding: 5px;"> <p><b>TEMP. &amp; PRES. SET</b><br/> <b>TEMP. : 26.0 °C</b><br/> <b>PRES. : 1017.0 hPa</b><br/> <b>INPUT — — ENTER</b></p> </div> |

\*1) Refer to Section 2.6 "How to Enter Alphanumeric characters".

- Range : Temp. -30 to +60°C (0.1°C step) or -22 to +140°F (0.1°F step)  
 Pres. 560 to 1066.0hPa (0.1hPa step) ,420 to 800mmHg (0.1mmHg step) or 16.5 to 31.5inHg (0.1inHg step)
- When the atmospheric correction value which is calculated from the input temperature and pressure values exceeds the range ± 999.9ppm, the operating procedure returns to step **3** automatically. Input values again.

● **How to Set the Atmospheric Correction Value Directly**

Measure the temperature and air pressure to find atmospheric correction value (PPM) from the chart or correction formula.

| Operating procedure                                                                                                            | Operation                  | Display                                                                                                       |
|--------------------------------------------------------------------------------------------------------------------------------|----------------------------|---------------------------------------------------------------------------------------------------------------|
| <p><b>1</b> Press the [F3](S/A) key to set Set Audio Mode from distance or coordinate measurement mode.</p>                    | [F3]                       | <pre> <b>SET AUDIO MODE</b> <b>PSM:0.0   PPM 0.0</b> <b>SIGNAL: [     ]</b> <b>PRISM PPM  T-P  ___</b> </pre> |
| <p><b>2</b> Press the [F2](PPM) key.<br/>Current setting value is displayed.</p>                                               | [F2]                       | <pre> <b>PPM SET</b> <b>PPM :   0.0  ppm</b> <b>INPUT ___  ___ ENTER</b> </pre>                               |
| <p><b>3</b> Enter atmospheric correction value. *1)<br/><br/>Mode returns to Set Audio mode.</p>                               | [F1]<br>Enter Data<br>[F4] |                                                                                                               |
| <p>*1) Refer to Section 2.6 “How to Enter Alphanumeric characters”.<br/>● Input range : -999.9ppm to +999.9ppm,0.1ppm step</p> |                            |                                                                                                               |

**Atmospheric Correction Chart (For your reference)**

The atmospheric correction value is obtained easily with the atmospheric correction chart. Find the measured temperature in horizontal, and pressure in vertical on the chart. Read the value from the diagonal line, which represents the required atmospheric correction value.

Example:

The measured temperature is +26°C

The measured pressure is 1013 hPa

There fore,

The correction value is +10ppm

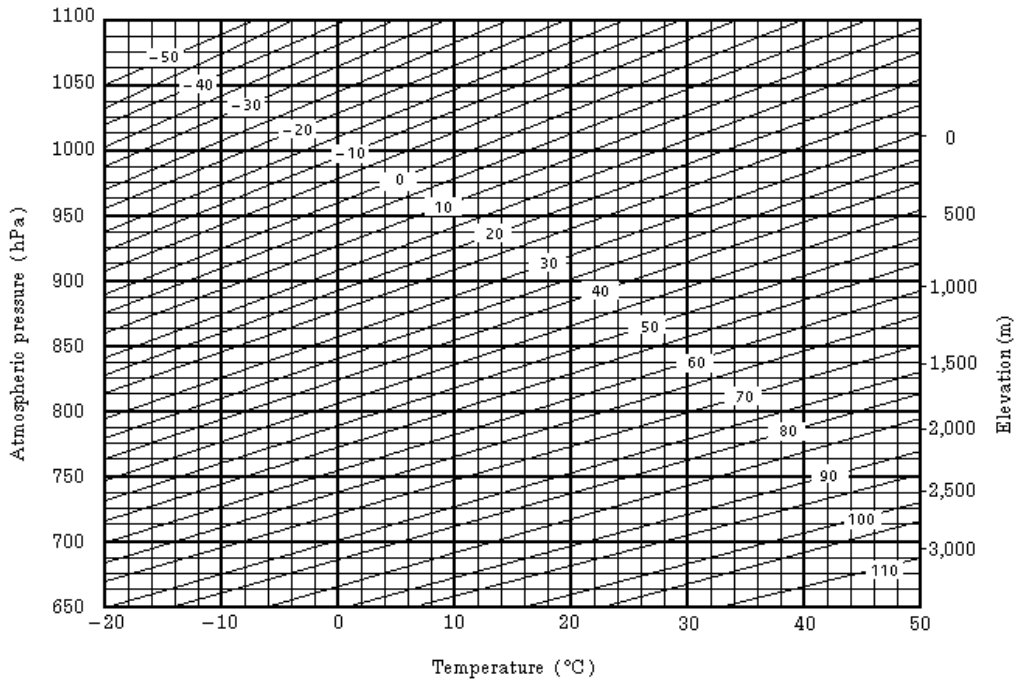

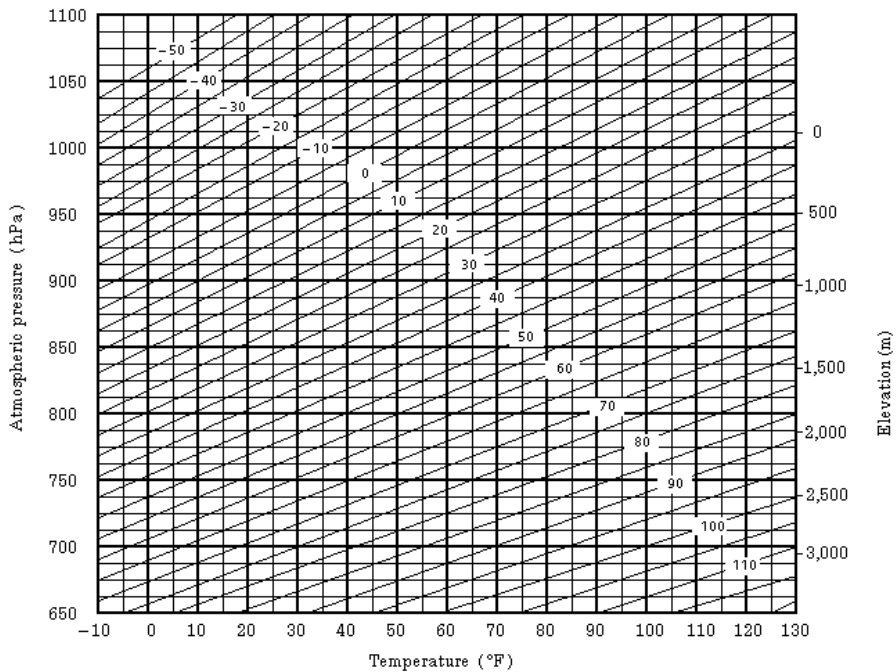
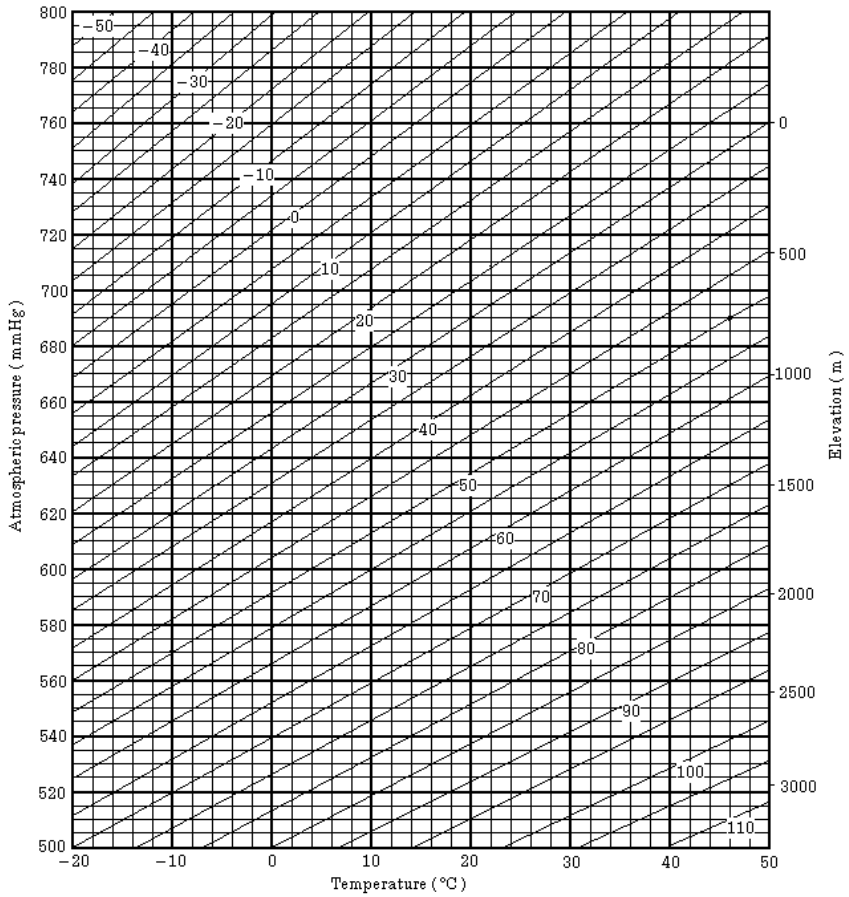

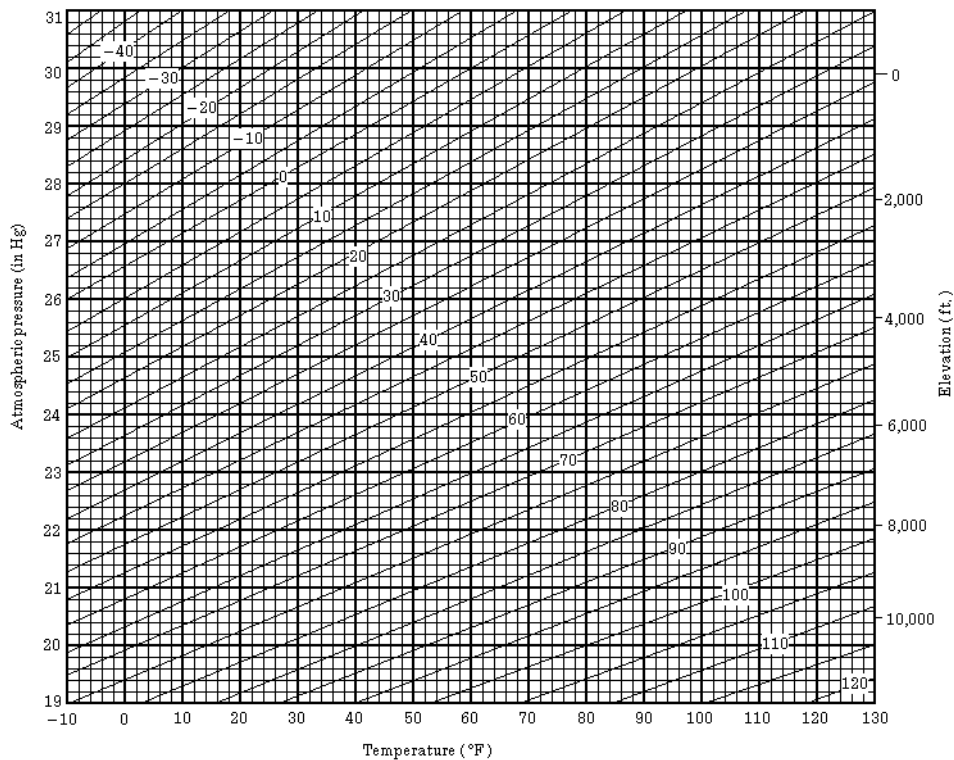



# 13 CORRECTION FOR REFRACTION AND EARTH CURVATURE

The instrument measures distance, taking into account correction for refraction and earth curvature.

## 13.1 Distance Calculation Formula

Distance Calculation Formula; with correction for refraction and earth curvature taken into account. Follow the Formula below for converting horizontal and vertical distances.

- Horizontal distance  $D = AC(\alpha)$  or  $BE(\beta)$
- Vertical distance  $Z = BC(\alpha)$  or  $EA(\beta)$
- $D = L\{\cos\alpha - (2\theta - \gamma) \sin\alpha\}$
- $Z = L\{\sin\alpha + (\theta - \gamma) \cos\alpha\}$
- $\theta = L \cdot \cos\alpha / 2R$ ..... Earth curvature correcting item
- $\gamma = K \cdot L \cos\alpha / 2R$ ..... Atmospheric refraction correcting item
- $K = 0.14$  or  $0.2$ ..... Coefficient of refraction
- $R = 6372\text{km}$ ..... Radius of earth
- $\alpha$  ( or  $\beta$ )..... Altitude angle
- $L$  ..... Slope distance

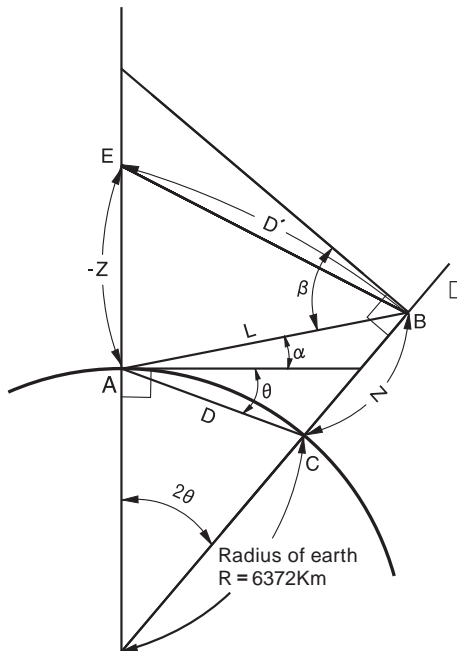

- The conversion formula for horizontal and vertical distances is as follows when correction for refraction and earth curvature is not applied.  
 $D = L \cdot \cos\alpha$   
 $Z = L \cdot \sin\alpha$

Note: The coefficient of the instrument has been set at 0.14 before shipment (K=0.14). if the "K" value is to be changed, refer to 16 "SELECTING MODE".

## 14 POWER SOURCE AND CHARGING

### 14.1 On-board Battery BT-52QA

- **To remove**

- 1 Confirm that the instrument is turned off before removing the battery.  
Push the battery locking lever and pull out the BT-52QA on-board battery as shown below.

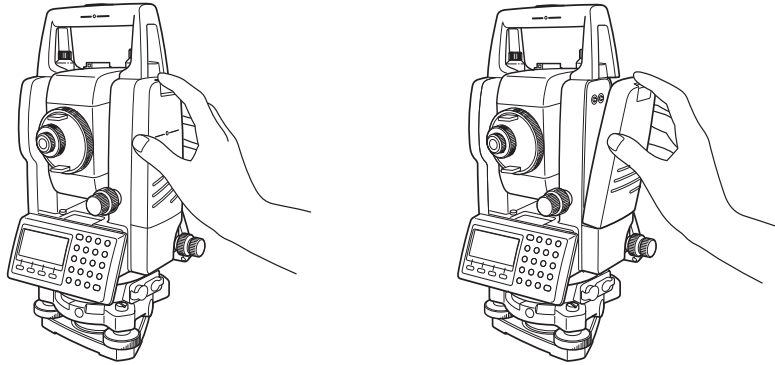

- **To charge**

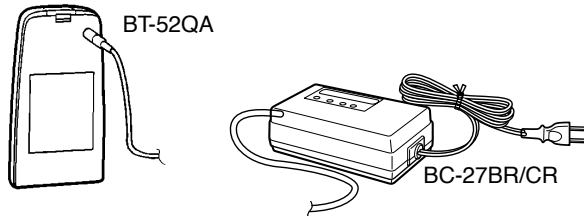

- 1 Plug the charger into the outlet.
- 2 Connect the charger connector to the battery, then charging will start.  
Preparatory charging will start. (The red lamp of the charger will blink.)  
When the preparatory charging is completed, the charging status will be switched to quick charging automatically. (The red lamp of the charger will light.)
- 3 Charging will take approximately 1.8 hours. (The green lamp will illuminate.)
- 4 After charging, remove the battery from the charger.
- 5 Remove the charger from the outlet.

- **To refresh**

Press the refresh switch after starting charging above steps (1, 2), then discharging will start. Confirm the yellow lamp illuminates.

After discharging is finished, charging will start automatically.

Time discharging battery charged fully is approximately 8 hours.

- **For refreshing**

Rechargeable battery can be used repeatedly by charging. If charging is repeated by the state that capacity of the battery still left, operating time of the battery may shorten. In this case, the voltage of the battery will be recovered by refreshing and operating time can be improved.

- **About Preparatory charging**

Before quick charging, the battery is charged using small amount current to measure its temperature and voltage.

When the temperature and voltage is within a range, the charging status will change to quick charging.

#### The lamp of charger

**Red blinking** : Preparatory charging /Waiting until internal temperature falls

**Red ON** : Charging

Red lamp will illuminate during charging.

**Green ON** : Charging completed

Green lamp will illuminate after completely charging.

**Yellow ON** : Discharging

Yellow lamp will illuminate and discharging will start by pressing the refresh (discharge) switch.

**Red quick flashing** : Abnormal outbreaks

Red lamp will flash when the battery life is over or the battery is broken down.

Replace the battery to new one.

**● To install**

- 1 Place the base of the on-board battery into the GTS-230N series, push the on-board battery toward the instrument side till the battery clicks into position.

- Do not charge or discharge continuously, otherwise the battery and the charger may be deteriorated. If charging or discharging is necessary, use the charger after stopping charge for approximately 30 minutes.
- Do not charge the battery or discharge the battery in right after the battery is charged, it causes deterioration of the battery in rare cases.
- The charger may develop heat while charging, there is no problem of it.

- Note:
- 1 Recharging should take place in a room with an ambient temperature range of 10°C to 40°C (50°F to 104°F).
  - 2 If charging is done at high temperature, charging time of the battery may take longer.
  - 3 Exceeding the specified charging time may shorten the life of the battery and should be avoided if possible.
  - 4 The battery source will discharge when stored and should be checked before using with instrument .
  - 5 Be sure to charge as stored battery source every 3 or 4 months and store in a place at 30°C and below when it will not used for a long period.  
If you allow the battery to be completely discharged, it will have an effect on the overall performance for proper charging in the future.  
Keep batteries charged at all times.
  - 6 For further information, see APPENDIX 2 “Precaution when Charging or Storing Batteries”.

## 15 DETACH/ATTACH OF TRIBRACH

The instrument is easily detached or attached to the tribrach, with a tribrach locking lever loosened or tightened for this purpose.

### ● Detachment

- 1) Loosen the tribrach locking lever, by revolving it 180° or 200g in the counterclockwise direction (which will point the triangle mark upwards).
- 2) Grip the carrying handle firmly with one hand while holding the tribrach with the other. Then lift the instrument straight upwards and off.

### ● Attachment

- 1) Hold the instrument by the carrying handle, with one hand, and carefully lower it on top of the tribrach while, at the same time, coinciding the alignment piece with the tribrach alignment groove on the instrument and tribrach respectively.
- 2) When fully seated, revolve the tribrach locking lever 180° or 200g clockwise ( which will point the triangle mark downwards again).

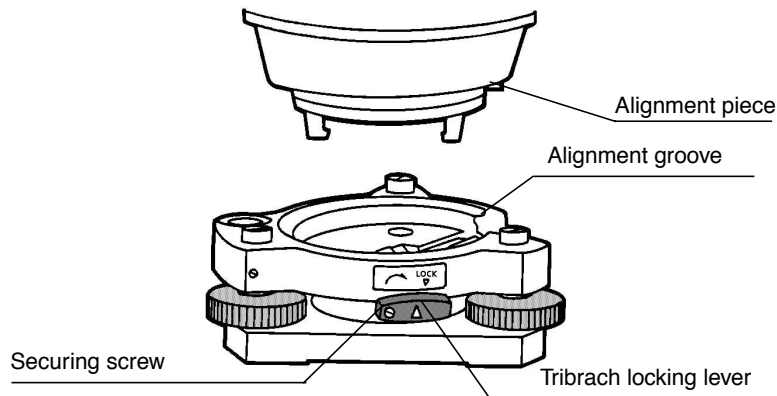

### ● Locking the Tribrach Locking Lever

The tribrach locking lever can be locked, to prevent it be accidentally removed, especially if the upper instrument section is not being detached very often. Simply tighten the securing screw on the locking lever with the accessory screwdriver, found in the case.

# 16 SELECTING MODE

## 16.1 Items of the Selecting Mode

The following modes are available.

| Menu              | Items               | Selecting item                                               | Display                                                                                                                                                                                                                                                                                                       |
|-------------------|---------------------|--------------------------------------------------------------|---------------------------------------------------------------------------------------------------------------------------------------------------------------------------------------------------------------------------------------------------------------------------------------------------------------|
| 1:<br>UNIT SET    | TEMP. &<br>PRES.    | °C / °F<br>hPa / mmHg /<br>inHg                              | Select the unit of temperature for atmospheric correction. Select the unit of air pressure for atmospheric correction .                                                                                                                                                                                       |
|                   | ANGLE               | DEG(360°) /<br>GON(400G) /<br>MIL(6400M)                     | Choose degree, gon or mil unit for measuring angle.                                                                                                                                                                                                                                                           |
|                   | DISTANCE            | METER / FEET /<br>FEET and inch                              | Choose measuring unit for distance meter , feet or feet and inch                                                                                                                                                                                                                                              |
|                   | FEET                | US SURVEY /<br>INTERNATIONAL                                 | Select the meter / feet conversion factor.<br>US SURVEY feet<br>1m=3.280833333333333 ft.<br>INTERNATIONAL feet<br>1m=3.280839895013123 ft.                                                                                                                                                                    |
| 2:<br>MODE<br>SET | POWER ON<br>MODE    | ANGLE MEAS./<br>DISTANCE MEAS.                               | Select to set the measurement mode for angle or distance when the power is turned on.                                                                                                                                                                                                                         |
|                   | FINE/CRS/<br>TRK    | FINE / COARSE /<br>TRACK                                     | Select Fine /Coarse / Tracking mode in distance measurement mode, when the power is turned on.                                                                                                                                                                                                                |
|                   | HD&VD/SD            | HD&VD /SD                                                    | Specify which is displayed first, horizontal and vertical distance or slope distance, when the power is turned on.                                                                                                                                                                                            |
|                   | V ANGLE<br>Z0/H0    | Zenith 0 /<br>Horizontal 0                                   | Choose the vertical angle reading from zenith or from level.                                                                                                                                                                                                                                                  |
|                   | N-TIMES /<br>REPEAT | N-TIMES /<br>REPEAT                                          | Select the measurement mode for distance when the power is turned on.                                                                                                                                                                                                                                         |
|                   | TIMES OF<br>MEAS.   | 0~99                                                         | Set N (number of times) for times of distance measurement. When setting number of times as 1, it is single measurement.                                                                                                                                                                                       |
|                   | NEZ / ENZ           | NEZ / ENZ                                                    | Select a coordinate displaying order either NEZ or ENZ.                                                                                                                                                                                                                                                       |
|                   | HA<br>MEMORY        | ON / OFF                                                     | Horizontal angle set can be retained after the power is turned off.                                                                                                                                                                                                                                           |
|                   | ESC KEY<br>MODE     | DATA COLLECT /<br>LAYOUT / REC /<br>OFF                      | You can select a function of the [ESC] key.<br>DATA COLLECT / LAYOUT: It is possible to enter data input mode (in DATA COLLECT) or Layout Menu from normal measuring mode directly.<br>REC: While executing normal or offset measuring, the measuring data can be output.<br>OFF: Returns to normal function. |
| COORD.<br>CHECK   | ON / OFF            | Select coordinate displaying ON or OFF when setting a point. |                                                                                                                                                                                                                                                                                                               |
|                   |                     |                                                              |                                                                                                                                                                                                                                                                                                               |

|                     |                |                                                         |                                                                                                                                                                                                                                                                                                                                                                                                                           |
|---------------------|----------------|---------------------------------------------------------|---------------------------------------------------------------------------------------------------------------------------------------------------------------------------------------------------------------------------------------------------------------------------------------------------------------------------------------------------------------------------------------------------------------------------|
|                     | EDM OFF TIME   | 0-99                                                    | The time when EDM is cut off from distance measurement is completed can be changed. This function is effective for shortening the first time measuring time when distance measurement is started from distance measurement completing state.<br>(Default:3minutes)<br>0 :After completing distance measurement, EDM is cut off immediately.<br>1-98 :EDM is cut off after 1~98 minutes.<br>99 :EDM is always switched ON. |
|                     | FINE READING   | 0.2/1mm                                                 | Select 1mm or 0.2mm for the minimum reading unit in the distance mode (FINE mode).                                                                                                                                                                                                                                                                                                                                        |
|                     | OFFSET V ANG   | FREE / HOLD                                             | Select Vertical angle setting in the Angle Offset measurement mode.<br>FREE: Vertical angle varies by the angle of the telescope.<br>HOLD: Vertical angle is fixed even if the angle of the telescope changes.                                                                                                                                                                                                            |
| 3:<br>OTHERS<br>SET | H-ANGLE BUZZER | ON / OFF                                                | Specify whether the buzzer sounds or not for every horizontal angle 90°.                                                                                                                                                                                                                                                                                                                                                  |
|                     | S/A BUZZER     | ON / OFF                                                | Specify whether the buzzer sounds or not in the set audio mode.                                                                                                                                                                                                                                                                                                                                                           |
|                     | W-CORRECTION   | OFF / K=0.14 / K=0.20                                   | Set correction for refraction and earth curvature, coefficient of refraction as ; K=0.14, K=0.20 or no correction.                                                                                                                                                                                                                                                                                                        |
|                     | NEZ MEMORY     | ON / OFF                                                | It is possible to retain the coordinate of instrument point, the instrument height and prism height after power off.                                                                                                                                                                                                                                                                                                      |
|                     | REC TYPE       | REC-A / REC-B                                           | Select REC-A or REC-B for data output.<br>REC-A :The measurement is made again and this new data is output.<br>REC-B : The data being displayed is output.                                                                                                                                                                                                                                                                |
|                     | CR,LF          | ON / OFF                                                | It is possible to output the data with carriage return and line feed.                                                                                                                                                                                                                                                                                                                                                     |
|                     | NEZ REC FORM   | STANDARD / STANDARD (12dig) / with RAW with RAW (12dig) | Select the format of the record coordinates data<br>STANDARD: 11 digits standard data<br>STANDARD (12dig):12 digits standard data with RAW:11digits standard data with raw data with RAW (12dig):12digits standard data with raw data                                                                                                                                                                                     |
|                     | MANUAL NEZ REC | ON/ OFF                                                 | In the layout mode or data collect mode, it is possible to record coordinates entered directly from the keyboard.                                                                                                                                                                                                                                                                                                         |
|                     | LANGUAGE *     | ENGLISH/ OTHER *                                        | Select the displaying language.                                                                                                                                                                                                                                                                                                                                                                                           |
|                     | ACK MODE       | STANDARD / OMITTED                                      | Set the procedure of the communication with external device.<br>STANDARD:Normal procedure<br>OMITTED:Even though the [ACK] is omitted from the external device, the data is not sent again.                                                                                                                                                                                                                               |
|                     | GRID FACTOR    | USE G.F. / DON'T USE                                    | Select using GRID FACTOR in calculation of measurement data.                                                                                                                                                                                                                                                                                                                                                              |

|               |                     |                                                                                                                                                                                                  |
|---------------|---------------------|--------------------------------------------------------------------------------------------------------------------------------------------------------------------------------------------------|
| CUT & FILL    | STANDARD / CUT&FILL | In the layout mode, CUT & FILL can be displayed instead of dZ.                                                                                                                                   |
| ECHO BACK     | ON / OFF            | It is possible to output the data of echo back type.                                                                                                                                             |
| CONTRAST MENU | ON / OFF            | When the instrument is turned ON, it is possible to display the screen which you can adjust contrast of the display and confirm the prism constant (PSM) and atmospheric correction value (PPM). |

\*LANGUAGE selection is different in each country.

## 16.2 How to Set Selecting Mode

<Example> : Setting unit in hPa, °F, NEZ MEMORY:ON

| Operating procedure                                                                    | Operation             | Display                                                                                                 |
|----------------------------------------------------------------------------------------|-----------------------|---------------------------------------------------------------------------------------------------------|
| <b>1</b> While pressing [F2] key, turn power ON.                                       | [F2]<br>+<br>Power ON | <b>PARAMETERS 2</b><br><b>F1:UNIT SET</b><br><b>F2:MODE SET</b><br><b>F3:OTHERS SET</b>                 |
| <b>2</b> Press [F1](UNIT SET ) key.                                                    | [F1]                  | <b>UNIT SET</b> 1/2<br><b>F1:TEMP. &amp; PRES.</b><br><b>F2:ANGLE</b><br><b>F3:DISTANCE</b> P↓          |
| <b>3</b> Press [F1](TEMP. & PRES.) key.                                                | [F1]                  | <b>TEMP. &amp; PRES. UNIT</b><br><b>TEMP. : °C</b><br><b>PRES. : mmHg</b><br><b>°C °F — ENTER</b>       |
| <b>4</b> Press [F2](°F) key, and press [F4](ENTER) key.                                | [F2]<br>[F4]          | <b>TEMP. &amp; PRES. UNIT</b><br><b>TEMP. : °F</b><br><b>PRES. : mmHg</b><br><b>hPa mmHg inHg ENTER</b> |
| <b>5</b> Press [F1](hPa) key, and press [F4] (ENTER) key.<br>Returns to unit set menu. | [F1]<br>[F4]          | <b>UNIT SET</b> 1/2<br><b>F1:TEMP. &amp; PRES.</b><br><b>F2:ANGLE</b><br><b>F3:DISTANCE</b>             |
| <b>6</b> Press [ESC] key.<br>Returns to PARAMETERS 2 menu.                             | [ESC]                 | <b>PARAMETERS 2</b><br><b>F1:UNIT SET</b><br><b>F2:MODE SET</b><br><b>F3:OTHERS SET</b>                 |
| <b>7</b> Press [F3](OTHERS SET) key.                                                   | [F3]                  | <b>OTHERS SET</b> 1/5<br><b>F1:H-ANGLE BUZZER</b><br><b>F2:S/A BUZZER</b><br><b>F3:W-CORRECTION</b> P↓  |
| <b>8</b> Press [F4](P↓) key, to get the function in page 2 .                           | [F4]                  | <b>OTHERS SET</b> 2/5<br><b>F1:NEZ MEMORY</b><br><b>F2:REC TYPE</b><br><b>F3:CR,LF</b> P↓               |

|                                                                                                                                                                   |                                                         |                                                                                                                                                                                                                                                                                                                          |
|-------------------------------------------------------------------------------------------------------------------------------------------------------------------|---------------------------------------------------------|--------------------------------------------------------------------------------------------------------------------------------------------------------------------------------------------------------------------------------------------------------------------------------------------------------------------------|
| <p><b>9</b> Press [F1] key.</p><br><p><b>10</b> Press [F1](ON) key, and press [F4] (ENTER) key.<br/>Returns to OTHERS SET menu.</p><br><p><b>11</b> Power off</p> | <p>[F1]</p><br><p>[F1]<br/>[F4]</p><br><p>Power OFF</p> | <div style="border: 1px solid black; padding: 5px; margin-bottom: 5px;"> <p><b>NEZ MEMORY [OFF]</b></p> <p><b>[ON] [OFF] — ENTER</b></p> </div> <div style="border: 1px solid black; padding: 5px;"> <p><b>OTHERS SET 2/5</b></p> <p><b>F1:NEZ MEMORY</b></p> <p><b>F2:REC TYPE</b></p> <p><b>F3:CR,LF P↓</b></p> </div> |
| <p>● Up or down arrow key can be used when there are four or more selection items.</p>                                                                            |                                                         |                                                                                                                                                                                                                                                                                                                          |



# 17 CHECK AND ADJUSTMENT

## 17.1 Checking and adjusting of instrument constant

Normally, the instrument constant does not have discrepancy. It is recommended you measure and compare with an accurately measured distance at a location where the precision is specifically monitored on a consistent basis. If such a location is not available, establish your own base line over 20m (when purchasing the instrument) and compare the data measured with the newly purchased instrument.

In both cases note that the setup displacement of the instrument position over the point, the prism, baseline precision, poor collimation, atmospheric correction, and correction for refraction and earth curvature determine the inspection precision. Please keep in mind these points.

Also, when providing a base line in a building, please note that differences in temperature greatly affect the length measured.

If a difference of 5mm or over is the result from the comparative measurement, the following procedure as shown below could be used to change the instrument constant.

- 1) Provide point C on a straight line, connecting straight line AB which is almost level and about 100m long. Measure straight lines AB, AC and BC.

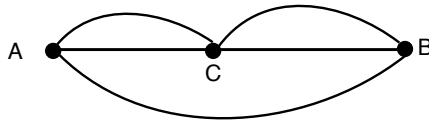

- 2) Obtain the instrument constant by repeating 1) above several times.  
Instrument constant =  $AC+BC-AB$
- 3) When there is error between written instrument constant value and calculated value, review Section 17.4 "How to Set the Instrument Constant Value"
- 4) Once again, measure at a calibrated baseline and compare results.
- 5) If using above procedure and no difference is found from the instrument constant at the factory or a difference of over 5mm is found, contact TOPCON or your TOPCON dealer.

Note: The seal with which the value is written is stuck on the lower part of the instrument, or the battery removal side of the instrument.

## 17.2 Checking the Optical Axis

To check if the optical axis of EDM and theodolite are matched, follow the procedure below. It is especially important to check after adjustment of the eyepiece reticle is carried out.

- 1) Position the Instrument and prism with about 2m apart and face them at each other.  
(At this time, the power is ON.)

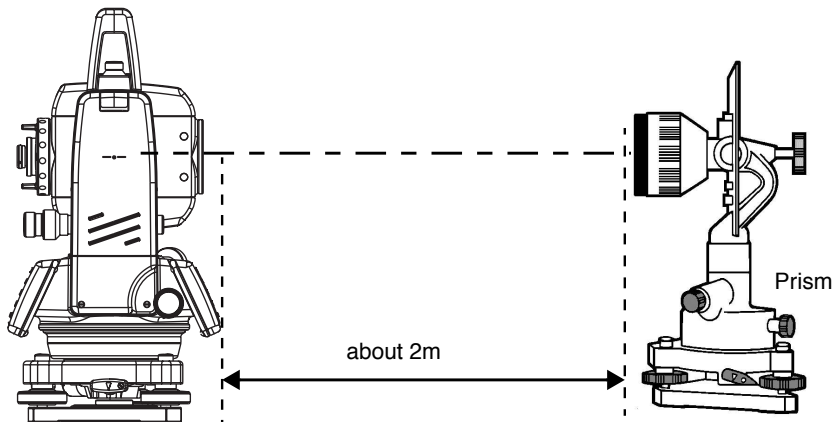

- 2) Sight through the eyepiece and focus to the prism. Then center the prism on the cross hairs.

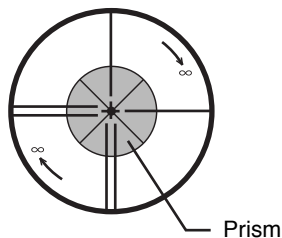

- 3) Set to the measure mode to distance measurement or set audio.
- 4) Sight through the eyepiece and focus the (blinking) red light spot by turning the focusing knob in the direction of infinity (clockwise). If displacement of the reticle cross hairs is within one-fifth of the diameter of the round red light spot both vertically and horizontally, adjustment will not be required.

**Note:** If displacement is more than one-fifth in the above case, and still remains so after rechecking the original line of sight, the instrument must be adjusted by competent technicians. Please contact TOPCON or your TOPCON dealer to adjust the instrument.

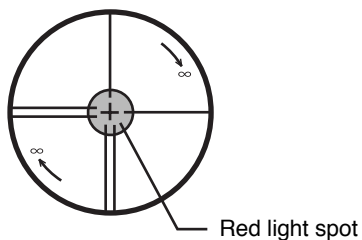

## 17.3 Checking/Adjusting the Theodolite Functions

### ● Pointers on the Adjustment

- 1) Adjust the eyepiece of the telescope properly prior to any checking operation which involves sighting through the telescope.  
Remember to focus properly, with parallax completely eliminated.
- 2) Carry out the adjustments in the order of item numbers, as the adjustments are dependent one upon another. Adjustments carried out in the wrong sequence may even nullify previous adjustment.
- 3) Always conclude adjustments by tightening the adjustment screws securely (but do not tighten them more than necessary, as you may strip the threads, twist off the screw or place undue stress on the parts).  
Furthermore, always tighten by revolving in the direction of tightening tension.
- 4) The attachment screws must also be tightened sufficiently, upon completion of adjustments.
- 5) Always repeat checking operations after adjustments are made, in order to confirm results.

### ● Notes on the Tribrach

Note that the angle measuring precision may be effected directly if the tribrach has not been installed firmly.

- 1) If any leveling screw becomes loose and slack or if collimation is unstable due to the looseness of leveling screws, adjust by tightening the adjusting screws (in 2 places) installed over each leveling screw with a screwdriver
- 2) If there is any slack between the leveling screws and the base, loosen the set screw of the holding ring and tighten the holding ring with adjusting pin, until it is properly adjusted. Re-tighten the set screw on completing the adjustment.

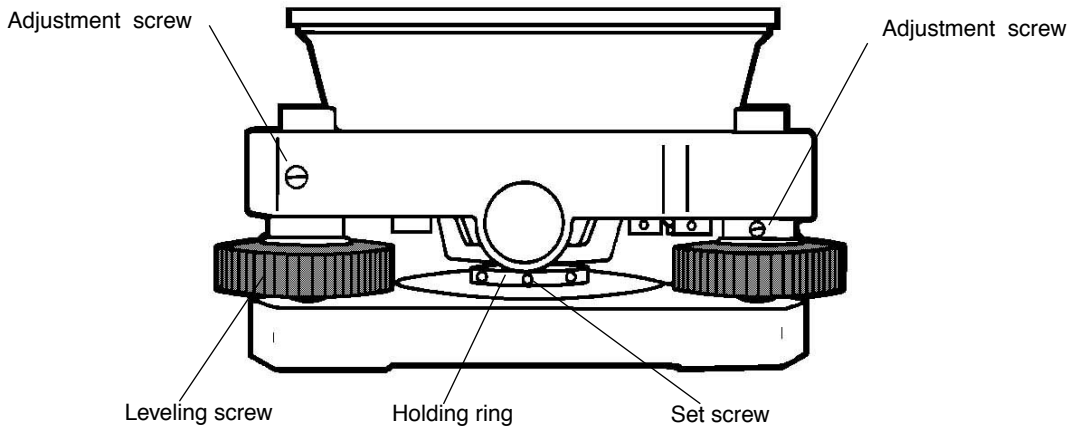

### 17.3.1 Checking /Adjusting the Plate Level

Adjustment is required if the axis of the plate level is not perpendicular to the vertical axis.

● **Check**

- 1) Place the plate level parallel to a line running through the centers of two leveling screws, say, A and B. Use these two leveling screws only and place the bubble in the center of the plate level.
- 2) Rotate the instrument 180° or 200g around the vertical axis and check bubble movement of the plate level. If the bubble has been displaced, then proceed with the following adjustment.

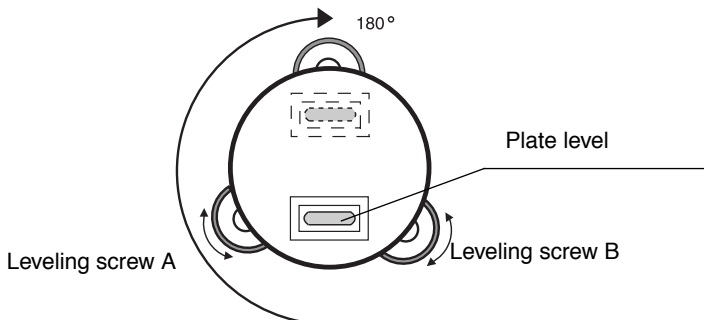

● **Adjustment**

- 1) Adjust the level adjustment capstan screw, with the accessory adjusting pin and return the bubble towards the center of the plate level. Correct only one-half of the displacement by this method.
- 2) Correct the remaining amount of the bubble displacement with the leveling screws.
- 3) Rotate the instrument 180° or 200g around the vertical axis once more and check bubble movement. If the bubble is still displaced, then repeat the adjustment.

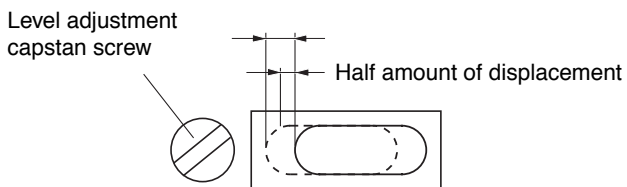

### 17.3.2 Checking /Adjusting the Circular Level

Adjustment is required if the axis of the circular level is also not perpendicular to the vertical axis.

● **Check**

- 1) Carefully level the instrument with the plate level only. If the bubble of the circular level is centered properly, adjustment is not required. Otherwise, proceed with the following adjustment.

● **Adjustment**

- 1) Shift the bubble to the center of the circular level, by adjusting three capstan adjustment screws on the bottom surface of the circular level, with the accessory adjusting pin.

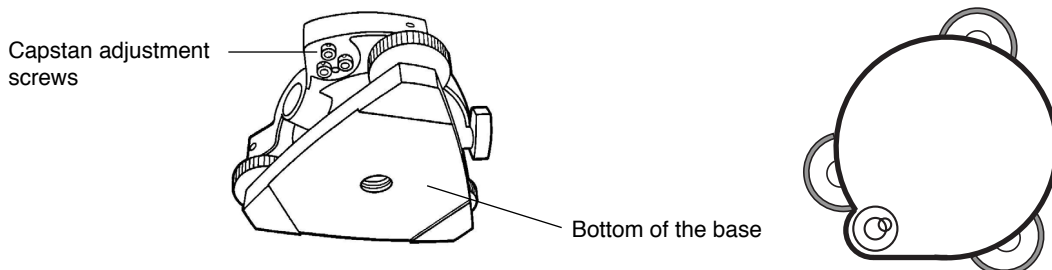

### 17.3.3 Adjustment of the Vertical Cross-hair

Adjustment is required if the vertical cross-hair is not in a plane perpendicular to the horizontal axis of the telescope ( since it must be possible to use any point on the hair for measuring horizontal angles or running lines).

#### ● Check

- 1) Set the instrument up the tripod and carefully level it.
- 2) Sight the cross-hairs on a well defined Point A at a distance of, at least, 50 meters (160ft.) and clamp horizontal motion.
- 3) Next swing the telescope vertically using the vertical tangent screw, and check whether the point travels along the length of the vertical cross-hair.
- 4) If the point appears to move continuously on the hair, the vertical cross-hair lies in a plane perpendicular to the horizontal axis ( and adjustment is not required ).
- 5) However, if the point appears to be displaced from the vertical cross-hair, as the telescope is swung vertically, then proceed with the following adjustment.

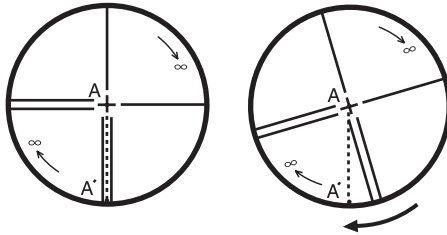

#### ● Adjustment

- 1) Unscrew the cross-hair adjustment section cover, by revolving it in the counterclockwise direction, and take it off. This will expose four eyepiece section attachment screws.

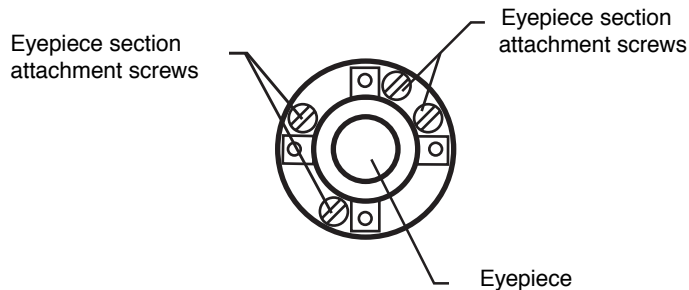

- 2) Loosen all four attachment screws slightly with the accessory screw-drive (while taking note of the number of revolutions).  
Then revolve the eyepiece section so that the vertical cross-hair coincides to Point A'.  
Finally, re-tighten the four screws by the amount that they were loosened.
- 3) Check once more and if the point travels the entire length of the vertical cross-hair, further adjustment is not required.

Note: Perform following adjustment after completing the above adjustment .  
Section 17.3.4 "Collimation of the Instrument", Section 17.3.6 "Adjustment of Vertical Angle 0 Datum".

### 17.3.4 Collimation of the Instrument

Collimation is required to make the line of sight of the telescope perpendicular to the horizontal axis of the instrument, otherwise, it will not be possible to extend a straight line by direct means.

● **Check**

- 1) Set the instrument up with clear sights of about 50 to 60 meters (160 to 200 ft.) on both sides of the instrument.
- 2) Level the instrument properly with the plate level.
- 3) Sight Point A at approximately 50 meters (160 ft.) distance.
- 4) Loosen the vertical motion clamp only, and rotate the telescope 180° or 200g around the horizontal axis, so that the telescope is pointed in the opposite direction.
- 5) Sight Point B, at equal distance as Point A and tighten the vertical motion clamp.
- 6) Loosen the horizontal motion clamp and rotate the instrument 180° or 200g around the vertical axis. Fix a sight on Point A once more and tighten the horizontal motion clamp.
- 7) Loosen the vertical motion clamp only and rotate the telescope 180° or 200g around the horizontal axis once more and fix a sight on Point C, which should coincide with previous Point B.
- 8) If Points B and C do not coincide, adjust in the following manner.

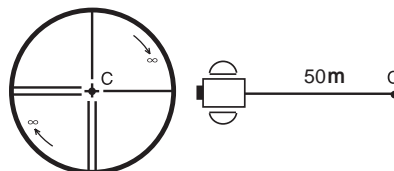
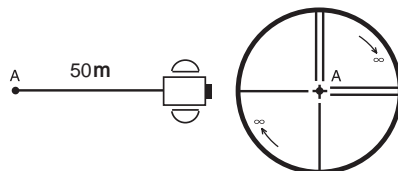
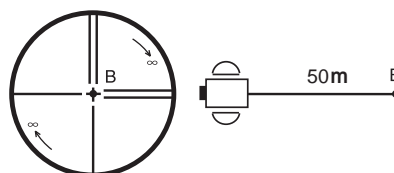
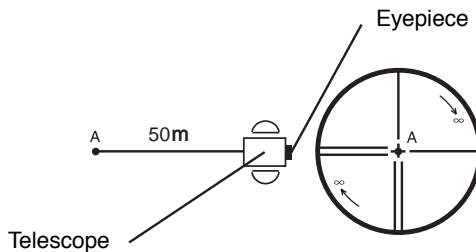

● **Adjustment**

- 1) Unscrew the cross-hair adjustment section cover.
- 2) Find Point D at a point between Points C and B, which should be equal to 1/4th the distance between Points B and C and measured from Point C. This is because the apparent error between Points B and C is four times the actual error since the telescope has been reversed twice during the checking operation.
- 3) Shift the vertical cross-hair line and coincide it with Point D, by revolving the left and right capstan adjustment screws with the adjusting pin. Upon completing the adjustment, repeat the checking operation once more.  
If Points B and C coincide, further adjustment is not required. Otherwise, repeat the adjustment.

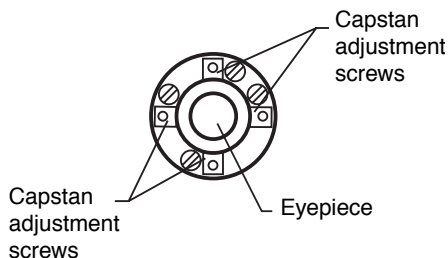
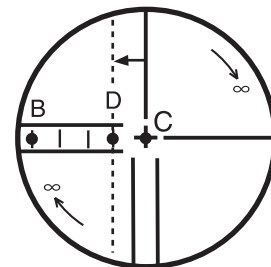

- Note: 1 First, loosen the capstan adjustment screw on the side to which the vertical cross-hair line must be moved. Then tighten the adjustment screw on the opposite side by an equal amount which will leave the tension of the adjustment screws unchanged. Revolve in the counterclockwise direction to loosen and in the clockwise direction to tighten, but revolve as little as possible.
- 2 Perform following adjustment after completing above adjustment . Section 17.3.6 "Adjustment of Vertical Angle 0 Datum", Section 17.2 "Checking the Optical Axis".

### 17.3.5 Checking / Adjusting the Optical Plummet Telescope

Adjustment is required to make the line of sight of the optical plummet telescope coincide with the vertical axis ( otherwise the vertical axis will not be in the true vertical when the instrument is optically plumbed).

#### ● Check

- 1) Coincide the center mark and the point. (See Chapter 2 "PREPARATION FOR MEASUREMENT".)
- 2) Rotate the instrument 180° or 200g around the vertical axis and check the center mark. If the point is properly centered in the center mark, adjustment is not required. Otherwise, adjust in the following manner.

#### ● Adjustment

- 1) Take off the adjustment section cover of the optical plummet telescope eyepiece. This will expose four capstan adjustment screws which should be adjusted with the accessory adjusting pin to shift the center mark to the point. However, correct only one-half of the displacement in this manner.

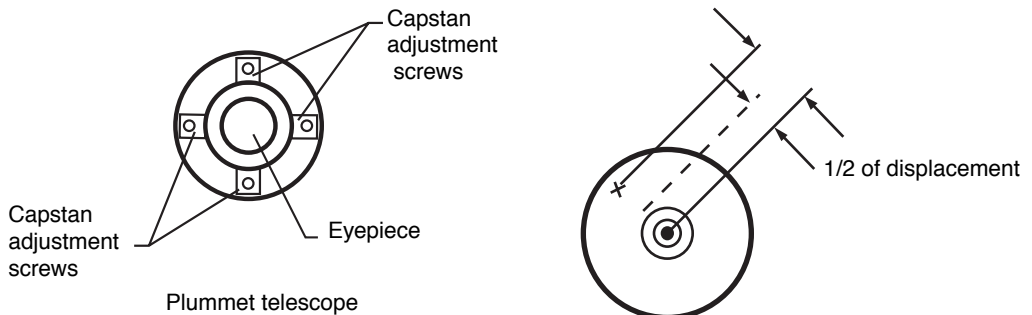

- 2) Use the leveling screws and coincide the point and center mark.
- 3) Rotate the instrument 180° or 200g around the vertical axis once more and check the center mark. If it is coincided to the point, then further adjustment is not required. Otherwise, repeat the adjustment.

- Note: First, loosen the capstan adjustment screw on the side to which the center mark must be moved. Then tighten the adjustment screw on the opposite side by an equal amount which will leave the tension of the adjustment screws unchanged. Revolve in the counterclockwise direction to loosen and in the clockwise direction to tighten, but revolve as little as possible.

### 17.3.6 Adjustment of Vertical Angle 0 Datum

If when measuring the vertical angle of target A at telescope position normal (direct) and reverse settings, the amount of normal and reverse measurements combined is other than 360° (ZENITH-0), half of the difference from 360° is the error amount from corrected 0 setting. Carry out adjustment. As adjustment for vertical angle 0 setting is the criteria for determining instrument coordinate origin, use special care for adjustment.

| Operating procedure                                                                                                                                | Operation                        | Display                                                                                                                                                                                                                                                                |
|----------------------------------------------------------------------------------------------------------------------------------------------------|----------------------------------|------------------------------------------------------------------------------------------------------------------------------------------------------------------------------------------------------------------------------------------------------------------------|
| <p><b>1</b> Level the instrument properly with the plate level.</p>                                                                                |                                  |                                                                                                                                                                                                                                                                        |
| <p><b>2</b> While pressing the [F1]key, turn power switch ON.</p>                                                                                  | <p>[F1]<br/>+<br/>Power ON</p>   | <div style="border: 1px solid black; padding: 5px;"> <p><b>ADJUSTMENT MODE 1/2</b><br/> <b>F1:V ANGLE 0 POINT</b><br/> <b>F2:INST. CONSTANT</b><br/> <b>F3:VO AXIS P↓</b></p> </div>                                                                                   |
| <p><b>3</b> Press the [F1] key.</p>                                                                                                                | <p>[F1]</p>                      | <div style="border: 1px solid black; padding: 5px;"> <p><b>VO ADJUSTMENT</b><br/> <b>&lt;STEP-1&gt; FRONT</b><br/> <b>V: 90°00'00"</b><br/> <b>ENTER</b></p> </div>                                                                                                    |
| <p><b>4</b> Collimate target A from the telescope properly in normal setting.</p>                                                                  | <p>Collimate A<br/>(Normal)</p>  |                                                                                                                                                                                                                                                                        |
| <p><b>5</b> Press the [F4](ENTER) key.</p>                                                                                                         | <p>[F4]</p>                      | <div style="border: 1px solid black; padding: 5px;"> <p><b>VO ADJUSTMENT</b><br/> <b>&lt;STEP-2&gt; REVERSE</b><br/> <b>V: 270°00'00"</b><br/> <b>ENTER</b></p> </div>                                                                                                 |
| <p><b>6</b> Collimate target A in reverse telescope setting.</p>                                                                                   | <p>Collimate A<br/>(Reverse)</p> |                                                                                                                                                                                                                                                                        |
| <p><b>7</b> Press the [F4](ENTER) key.<br/>Measured value is set and carry out normal angle measurement.</p>                                       | <p>[F4]</p>                      | <div style="border: 1px solid black; padding: 5px; text-align: center;"> <p><b>&lt;SET!&gt;</b></p> <p>↓</p> <div style="border: 1px solid black; padding: 5px;"> <p><b>V : 270°00'00"</b><br/> <b>HR: 120°30'40"</b><br/> <b>OSET HOLD HSET P1↓</b></p> </div> </div> |
| <p><b>8</b> Check that the total amount of normal and reverse angular travel is 360° collimating the target A by normal and reverse positions.</p> |                                  |                                                                                                                                                                                                                                                                        |



## 17.4 How to Set the Instrument Constant Value

To set the Instrument constant which is obtained in Section 17.1 “Check and adjusting of instrument constant”, follow as below.

| Operating procedure                                                                                                 | Operation                   | Display                                                                                                                                                                                                 |
|---------------------------------------------------------------------------------------------------------------------|-----------------------------|---------------------------------------------------------------------------------------------------------------------------------------------------------------------------------------------------------|
| <b>1</b> While pressing the [F1] key, turn power switch ON.                                                         | [F1]<br>+<br>POWER ON       | <div style="border: 1px solid black; padding: 5px;"> <b>ADJUSTMENT MODE 1/2</b><br/> <b>F1:V ANGLE 0 POINT</b><br/> <b>F2:INST. CONSTANT</b><br/> <b>F3:VO AXIS P↓</b> </div>                           |
| <b>2</b> Press the [F2] key.                                                                                        | [F2]                        | <div style="border: 1px solid black; padding: 5px;"> <b>INST. CONSTANT SET</b><br/> <b>INST. CONSTANT</b><br/> <b>: - 0.6 mm</b><br/> <b>INPUT — — ENTER</b><br/> <b>[---] [---] [CLR] [ENT]</b> </div> |
| <b>3</b> Enter the constant value. *1),2)                                                                           | [F1]<br>Enter value<br>[F4] | <div style="border: 1px solid black; padding: 5px;"> <b>INST. CONSTANT SET</b><br/> <b>INST. CONSTANT</b><br/> <b>: - 0.7 mm</b><br/> <b>INPUT — — ENTER</b> </div>                                     |
| <b>4</b> Turn power switch OFF.                                                                                     | Power OFF                   |                                                                                                                                                                                                         |
| *1) Refer to Section 2.6 “How to Enter Alphanumeric characters”.<br>*2) To cancel the setting, press the [ESC] key. |                             |                                                                                                                                                                                                         |

## 17.5 Adjustment of Compensation Systematic Error of Instrument

(Only for GTS-233N/235N/236N)

| Operating procedure                                                                                                                                                                                                                 | Operation                        | Display                                                                                                                                                                                           |
|-------------------------------------------------------------------------------------------------------------------------------------------------------------------------------------------------------------------------------------|----------------------------------|---------------------------------------------------------------------------------------------------------------------------------------------------------------------------------------------------|
| <p><b>1</b> Level the instrument properly with the plate level.</p>                                                                                                                                                                 | <p>[F1]<br/>+<br/>Power ON</p>   | <div style="border: 1px solid black; padding: 5px;"> <p><b>ADJUSTMENT MODE 1/2</b><br/> <b>F1:V ANGLE 0 POINT</b><br/> <b>F2:INST. CONSTANT</b><br/> <b>F3:VO AXIS P↓</b></p> </div>              |
| <p><b>2</b> While pressing the [F1] key, turn power switch ON.</p>                                                                                                                                                                  |                                  | <div style="border: 1px solid black; padding: 5px;"> <p><b>VO AXIS</b><br/> <b>F1:MEASUREMENT</b><br/> <b>F2:CONSTANT LIST</b></p> </div>                                                         |
| <p><b>3</b> Press the [F3] key.</p>                                                                                                                                                                                                 | <p>[F3]</p>                      | <div style="border: 1px solid black; padding: 5px;"> <p><b>VO/AXIS ADJUSTMENTS</b></p> </div>                                                                                                     |
| <p><b>4</b> Press the [F1] key.</p>                                                                                                                                                                                                 | <p>[F1]</p>                      | <div style="border: 1px solid black; padding: 5px;"> <p style="text-align: center;">↓</p> <p><b>ERROR CORRECTION</b><br/> <b>(A) COLLIMATION</b><br/> <b>(B) H AXIS</b></p> </div>                |
| <p><b>5</b> Collimate target A (around 0° in horizontal within ±3°) in normal telescope setting (FACE (1)).</p>                                                                                                                     | <p>Collimate A<br/>(Normal)</p>  | <div style="border: 1px solid black; padding: 5px;"> <p><b>FRONT FACE1 /0</b><br/> <b>V: 89°55'50"</b><br/> <b>LEVEL ±0</b><br/> <b>SKIP SET</b></p> </div>                                       |
| <p><b>6</b> Press the [F4](SET) key. *1<br/>The sample display shows that the measurement is made 5 times in FACE 1.</p>                                                                                                            | <p>[F4]</p>                      |                                                                                                                                                                                                   |
| <p><b>7</b> Turn the telescope in reverse telescope setting (FACE (2)).</p>                                                                                                                                                         | <p>Turn telescope</p>            | <div style="border: 1px solid black; padding: 5px;"> <p><b>REVERSE FACE2 5/5</b><br/> <b>V: 270°04'20"</b><br/> <b>LEVEL ±0</b><br/> <b>SET</b></p> </div>                                        |
| <p><b>8</b> Collimate target A.</p>                                                                                                                                                                                                 | <p>Collimate A<br/>(Reverse)</p> | <div style="border: 1px solid black; padding: 5px;"> <p style="text-align: center;">↓</p> <p><b>(B) HORIZONTAL AXIS</b></p> </div>                                                                |
| <p><b>9</b> Press the [F4](SET) key.<br/>Repeat the procedures in step <b>8</b> and <b>9</b> so that the count of measured times matches to the one in FACE(1). *2),3),4)</p> <p>The title display will be shown automatically.</p> | <p>[F4]</p>                      | <div style="border: 1px solid black; padding: 5px;"> <p style="text-align: center;">↓</p> <p><b>REVERSE FACE 2 /0</b><br/> <b>V: 270°04'20"</b><br/> <b>LEVEL ±10°</b><br/> <b>SET</b></p> </div> |
| <p><b>10</b> Collimate target B (more than ±10° from the level) in reverse telescope setting (FACE(2)). *5)</p>                                                                                                                     | <p>Collimate B<br/>(Reverse)</p> | <div style="border: 1px solid black; padding: 5px;"> <p><b>FRONT FACE 1 5/5</b><br/> <b>V: 89°55'50"</b><br/> <b>LEVEL ±10°</b><br/> <b>SKIP SET</b></p> </div>                                   |
| <p><b>11</b> Press the [F4](SET) key. *5)</p>                                                                                                                                                                                       | <p>[F4]</p>                      | <div style="border: 1px solid black; padding: 5px;"> <p style="text-align: center;">↓</p> </div>                                                                                                  |
| <p><b>12</b> Turn the telescope in normal telescope setting (FACE(1)).</p>                                                                                                                                                          | <p>Turn telescope</p>            | <div style="border: 1px solid black; padding: 5px;"> <p><b>FRONT FACE 1 5/5</b><br/> <b>V: 89°55'50"</b><br/> <b>LEVEL ±10°</b><br/> <b>SKIP SET</b></p> </div>                                   |
| <p><b>13</b> Collimate target B.</p>                                                                                                                                                                                                | <p>Collimate B<br/>(Normal)</p>  | <p style="text-align: center;">↓</p>                                                                                                                                                              |
| <p></p>                                                                                                                                                                                                                             | <p>[F4]</p>                      |                                                                                                                                                                                                   |

**14** Press the [F4](SET) key. Repeat the procedures in step **13** and **14** so that the count of measured times matches to the one in FACE(2). Then the display returns to main menu.

- To show the constant list of systematic error of instrument

**1** Press the [F3] key from Adjustment Mode menu 1/2.

[F3]

**COMPLETE**

**ADJUSTMENT MODE 1/2**  
**F1:V ANGLE 0 POINT**  
**F2:INST. CONSTANT**  
**F3:VO AXIS P↓**

**2** Press the [F2] key. Correction values are displayed.

[F2]

**VO AXIS**  
**F1:MEASUREMENT**  
**F2:CONSTANT LIST**

**VCo: -1°57'12"**  
**HCo: -0°00'20"**  
**HAx: -0°00'20"**  
**EXIT**

**3** Press the [F1] key. The display returns to previous menu.

[F1]

- \*1) It is able to get the average value from 1 to 10 measurements. To get the average, repeat the procedures in steps **5, 6 or 10, 11**. The measured times is counted in the second line of display.
- \*2) The compensation values of 1) Error of vertical axis (X,Y tilt sensor offset), 2) Collimation error, and 3) Error of vertical angle 0datum will be set and memorized internally.
- \*3) The operating procedure steps to set compensation value of 4) Error of horizontal axis.
- \*4) Pressing the [F1](SKIP) key enables to set next step without changing the last compensated value.
- \*5) Pressing the [F1](SKIP) key makes end of setting without changing compensation value.

## 17.6 Reference frequency check mode

The beam modulated by the reference frequency of EDM is emitted continuously.  
This mode is used for frequency test mainly.

| Operating procedure                                                                        | Operation             | Display                                                                                                     |
|--------------------------------------------------------------------------------------------|-----------------------|-------------------------------------------------------------------------------------------------------------|
| <b>1</b> While pressing the [F1] key, turn power switch ON.                                | [F1]<br>+<br>POWER ON | <b>ADJUSTMENT MODE 1/2</b><br><b>F1:V ANGLE 0 POINT</b><br><b>F2:INST. CONSTANT</b><br><b>F3:VO AXIS P↓</b> |
| <b>2</b> Press the [F4](P↓) key to get the function as in page 2.                          | [F4]                  | <b>ADJUSTMENT MODE 2/2</b><br><b>F1:FRQ CHECK MODE</b><br><br><b>P↓</b>                                     |
| <b>3</b> Press the [F1](FRQ CHECK MODE) key.                                               | [F1]                  | <b>FRQ CHECK MODE</b><br><br><b>EXIT</b>                                                                    |
| <b>4</b> Press the [F1](EXIT) key.<br>The display will return to Adjustment mode menu 2/2. | [F1]                  | <b>ADJUSTMENT MODE 2/2</b><br><b>F1:FRQ CHECK MODE</b><br><br><b>P↓</b>                                     |

## 18 PRECAUTIONS

- 1) For transportation, hold by the handle or yoke of the instrument. Never hold by the lens barrel as it can affect the fixing bracket inside and reduce the accuracy of the instrument.
- 2) Never expose the instrument without a filter to direct sunlight. It may damage the components inside the instrument.
- 3) Never leave the instrument unprotected in high temperature. The temperature inside instrument may easily reach up to 70°C or above and will reduce the service life.
- 4) The instrument should be stored in the room temperature range of minus 30°C to plus 60°C.
- 5) When a high degree of precision is required for measurement, provide shade against direct sunlight for the instrument and tripod.
- 6) Any sudden change of temperature to the instrument or prism may result in a reduction of measuring distance range, i.e. when taking the instrument out from a heated vehicle.
- 7) When opening the carrying case and taking out the instrument, place the case horizontally, then open the case.
- 8) When returning the instrument to its case, be sure to match the white positioning marks provided with the case and place the instrument with the eyepiece upward.
- 9) For transportation, provide dampening or a cushion appropriately to avoid sudden shock or vibration.
- 10) For cleaning the instrument after use, remove dust using a cleaning brush, then wipe off with a cloth.
- 11) For cleaning the lens surface, use a cleaning brush to remove the dust, then use a clean lintless cotton cloth. Moisten it with alcohol ( or mixture with ether ) to wipe gently in a rotational motion from the center out.
- 12) Even if any abnormality occurs, never attempt to disassemble or lubricate the instrument yourself. Always consult with TOPCON or your dealer.
- 13) To remove the dust on the case, never use thinner or benzine. Use a clean cloth moistened with neutral detergent.
- 14) Check each part of the tripod after extended use. Parts (screws or clamps) may work themselves free.

## 19 SPECIAL ACCESSORIES

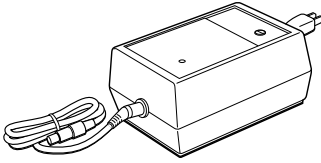

### Battery charger BC-6 (for BT-3L)

- Input voltage: 100, 120, 220, 240V  
AC:  $\pm 10\%$  50/60 Hz
- Power consumption: 15VA approx.
- Charging time:  
approx. 15 hour (+20°C) to charge BT-3L
- Operation temperature range:  
+10°C to +40°C (+50 to +104°F)
- External dimensions:  
142(L)  $\times$  96(W)  $\times$  64(H) mm
- Weight: 1.0kg

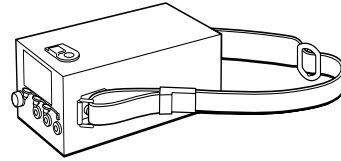

### Large capacity battery pack BT-3L

- Output voltage : DC 8.4V
- Capacity: 6AH
- External dimensions:  
190(L)  $\times$  106(W)  $\times$  74(H) mm
- Weight: 2.8kg

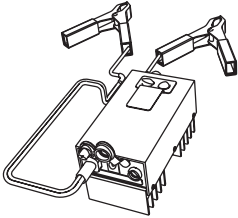

### Auto converter AC-6

- Input voltage : DC12V
- Output voltage : DC 8.4V $\pm 5\%$
- Current rating : 3A
- Connection cable length : Approx. 3m
- External dimensions :  
100(L)  $\times$  50(W)  $\times$  52(H) mm
- Weight : Approx. 0.3kg

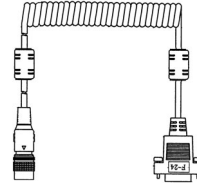

### Interface cable F-24

- Cable for communicating an external instrument and GTS-230N by the serial signal connector.

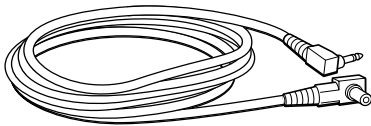

### Power cord PC-6 (For BT-3L)

- L-shape plug provided
- Cord length: 2m approx.

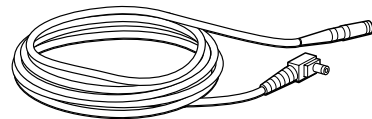

### Power cord PC-3 (For AC-6)

- L-shape plug provided
- Cord length: 2m approx.

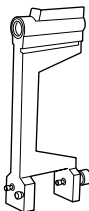

### Trough compass, Model 6

Shock proof construction. No clamp is necessary when carrying the instrument.

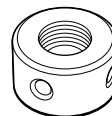

### Solar reticle, Model 6

A reticle designed for collimation of the sun. Can be used together with Solar Filter.

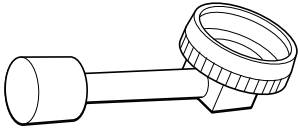
**Diagonal eyepiece, Model 10**

Observation in an easy posture will be provided up to the zenith position

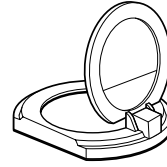
**Solar filter, Model 6**

A filter designed exclusively for direct collimation of the sun.

Solar filter of flap-up type.

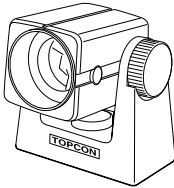
**Mini prism**

The mini prism (25.4mm) is made from precision ground glass and mounted in high impact plastic housings.

- The mini has the unique capability of being positioned either at a "0" or "-30" with the same prism

**Prism sets**

See the description on Chapter 21 "PRISM SYSTEM"

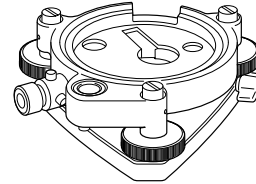
**Optical plummet tribrach**

This is detachable tribrach having built-in optical plummet telescope.

(Compatible with Wild)

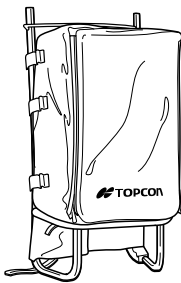
**Back pack, Model 2**

Convenient for use in mountainous terrain.

**Gadget case, Model 1**

A case to store and carry accessories.

- External dimensions:  
300(L)×145(W)×220(H) mm
- Weight:1.4kg

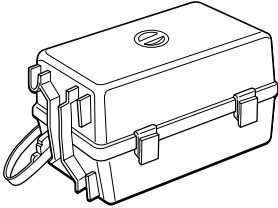

### Prism unit case, Model 3

This is the plastic case to store and carry various sets of prisms.

The case covers one of the following prism sets:

- Tilt single prism set
- Tilt single prism set with a target plate
- Fixed triple prism unit
- Fixed triple prism unit with a target plate
- External dimensions:  
427(L)×254(W)×242(H) mm
- Weight:3.1kg

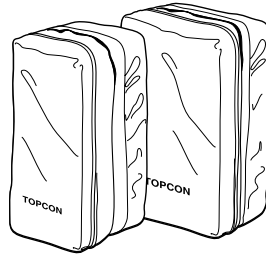

### Prism unit case, Model 6

Fixed 9 prisms unit or tilting 3 prisms unit can be stored in this case. Especially, this is a very easy case to carry. Soft material is used.

- External dimensions:  
250(L)×120(W)×400(H) mm
- Weight:0.5kg

### Prism unit case, Model 5

1 prisms unit or fixed 3 prisms unit can be stored in this case. Especially, this is a very easy case to carry. Soft material is used.

- External dimensions:  
200(L)×200(W)×350(H) mm
- Weight:0.5kg

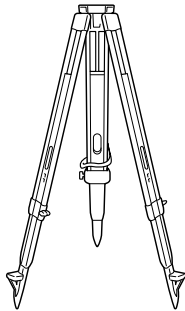

### Aluminum extension leg tripod, Type E

- Flat head 5/8" × 11 threads with adjustable legs.

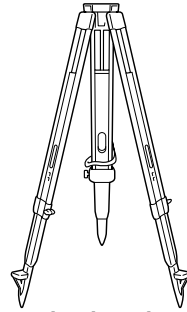

### Wide-frame extension leg tripod, Type E (Wood)

- Flat head 5/8" × 11 threads with adjustable legs.



# 20 BATTERY SYSTEM

In case of On-board battery

In case of External battery Pack

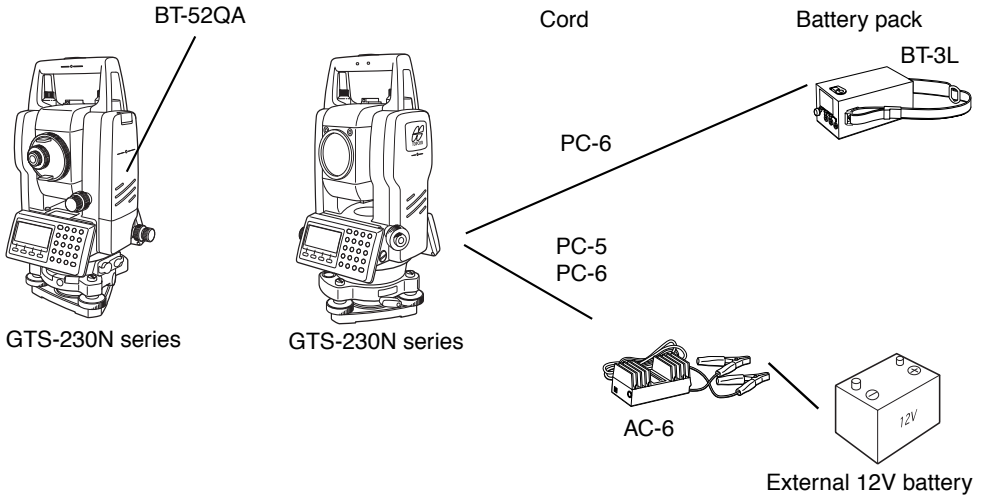

Charging

Charging time

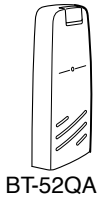

Approx. 1.8h

BC-27BR/CR

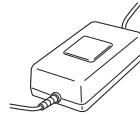

Quick  
BC-27BR for AC 120V use  
BC-27CR for AC 230V use

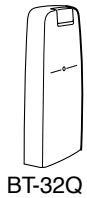

Approx. 1.5h

BC-19BR/CR

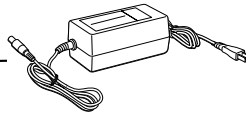

Quick  
BC-19BR for AC 120V use  
BC-19CR for AC 230V use

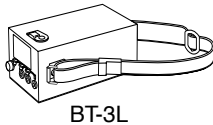

Approx. 15h

BC-6

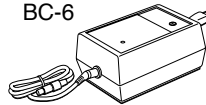

Normal  
for AC 100V / 120V / 220V /  
240V use

# 21 PRISM SYSTEM

Arrangement according to your needs is possible.

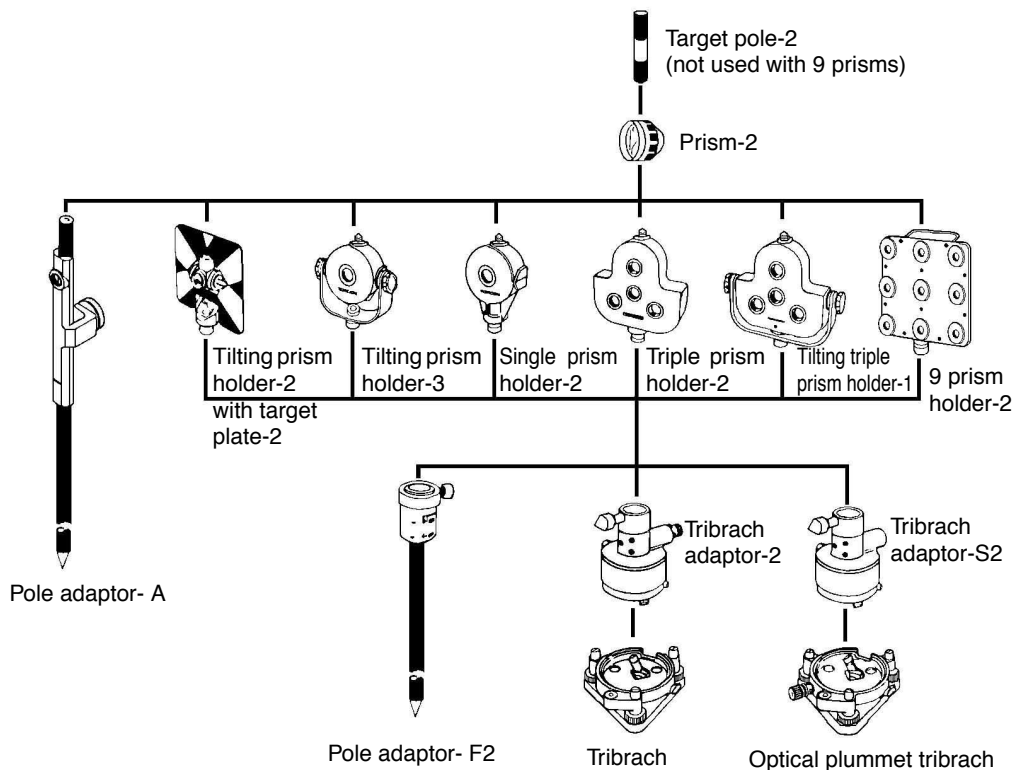

It is possible to change the combination according purpose.

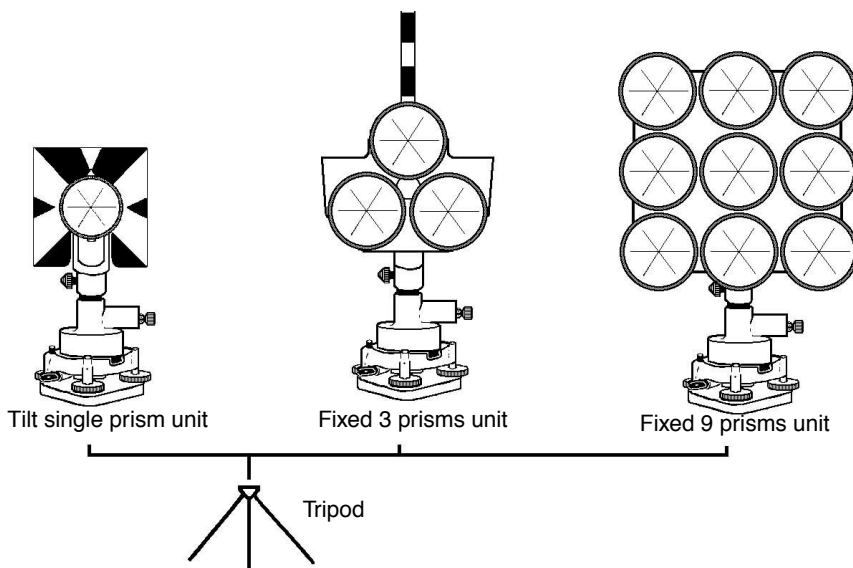

Use the above prisms after setting them at the same height as the instruments. To adjust the height of prism set, change the position of 4 fixing screws.

## 22 ERROR DISPLAYS

| Error code               | Description                                                                                                   | Countermeasures                                                                    |
|--------------------------|---------------------------------------------------------------------------------------------------------------|------------------------------------------------------------------------------------|
| 3 points required        | When area calculating, there are less than 3 points coordinate data in selected file.                         | Confirm the file data and calculate again.                                         |
| CALC ERROR               | Calculation is impossible from the data input.                                                                | Confirm the input data.                                                            |
| DELETE ERROR             | When deleting coordinate data, it can not be done successful.                                                 | Confirm the data and delete again.                                                 |
| E35                      | Displayed when REM measurement carried out to the range from zenith or nadir $\pm 6^\circ$ .                  | Operate in the range out of $\pm 6^\circ$ from the zenith or nadir.                |
| E60's                    | Any abnormality occurs with EDM (distance measuring system).                                                  | Repair is required.                                                                |
| E71                      | Displayed when vertical angle 0 position is set with incorrect procedure.                                     | Confirm the procedure and readjust.                                                |
| E72                      | Displayed when Vertical angle -position is adjusted in wrong position.                                        | Repair is required.                                                                |
| E73                      | The instrument was not leveled when Vertical angle 0-position is adjusted.                                    | Level the instrument then carry the adjustment work.                               |
| E80's                    | Mainly at the time data transmission between GTS-230N series and external instrument.                         | Confirm operation procedure is correct or the connection cables are correct.       |
| E90's                    | Abnormality in internal memory system.                                                                        | Repair is required.                                                                |
| FILE EXISTS              | The same file name exists.                                                                                    | Use another file name.                                                             |
| FULL FILES               | When making a file, 30 files already exist.                                                                   | If necessary, send or delete files.                                                |
| FAILED INITIALIZE        | Initializing can not be done successful.                                                                      | Confirm initializing data and try to initialize again.                             |
| LIMIT OVER               | Limit of input data exceeded.                                                                                 | Input again.                                                                       |
| MEMORY ERROR             | Any abnormality occurs with internal memory.                                                                  | Initialize the internal memory.                                                    |
| MEMORY POOR              | Shortage of capacity of the internal memory.                                                                  | Download data from internal memory to PC.                                          |
| NO DATA                  | The data is not found in the search mode                                                                      | Confirm the data and search again.                                                 |
| NO FILE                  | There is no file in internal memory.                                                                          | If necessary, make files.                                                          |
| FILE NOT SELECTED        | When using a file, no file is selected.                                                                       | Confirm the file and select a file.                                                |
| P1-P2 distance too short | When in point to line measurement, the horizontal distance between first point and second point is within 1m. | The horizontal distance between first point and second point must be more than 1m. |
| CIRCULAR ERROR           | Known points and occupied point are on the same circle at the resection mode.                                 | Take the different point.                                                          |

|                                                  |                                                                             |                                                               |
|--------------------------------------------------|-----------------------------------------------------------------------------|---------------------------------------------------------------|
| PT# EXIST                                        | Same new point name is already memorized in the memory.                     | Confirm the new point name and input again.                   |
| PT# DOES NOT EXIST                               | When you enter incorrect name or PT# does not exist in the internal memory. | Enter the correct name or enter point in the internal memory. |
| RANGE ERROR                                      | When setting a new point, calculation is impossible from the measured data. | Measure again.                                                |
| Tilt Over                                        | Instrument tilts over more than 3 minutes.                                  | Level the instrument properly.                                |
| V ANGLE ERROR<br>H ANGLE ERROR<br>VH ANGLE ERROR | Abnormality in angle measuring system.                                      | If this error code continues to display, repair is required.  |

- If error still persist after attempting to clear them, contact your local Topcon dealer or Topcon head office.

## 23 SPECIFICATIONS

### Telescope

|                      |                   |
|----------------------|-------------------|
| Length               | : 150mm           |
| Objective lens       | : 45mm (EDM 50mm) |
| Magnification        | : 30x             |
| Image                | : Erect           |
| Field of view        | : 1°30'           |
| Resolving power      | : 2.5"            |
| Minimum focus        | : 1.3m            |
| Reticle illumination | : Provided        |

### Distance measurement

Measurement range

| Model                            | Prism      | Atmospheric conditions |                   |
|----------------------------------|------------|------------------------|-------------------|
|                                  |            | Condition 1            | Condition 2       |
| GTS-233N<br>GTS-235N<br>GTS-236N | Mini prism | 1,000m (3,300ft)       | ----              |
|                                  | 1 prism    | 3,000m (9,900ft)       | 3,500m (11,500ft) |
|                                  | 3 prisms   | 4,000m (13,200ft)      | 4,700m (15,400ft) |
|                                  | 9 prisms   | 5,000m (16,400ft)      | 5,800m (19,000ft) |
| GTS-239N                         | Mini prism | 900m (3,000ft)         | ----              |
|                                  | 1 prism    | 2,000m (6,600ft)       | 2,300m (7,500ft)  |
|                                  | 3 prisms   | 2,700m (8,900ft)       | 3,100m (10,200ft) |
|                                  | 9 prisms   | 3,400m (11,200ft)      | 4,000m (13,200ft) |

Condition 1: Sight haze with visibility about 20km (12.5miles) moderate sunlight with light heat shimmer.

Condition 2: No haze with visibility about 40km(25 miles), overcast with no heat shimmer.

Measurement accuracy

|                    |                                                   |
|--------------------|---------------------------------------------------|
| GTS-233N/235N/236N | : $\pm(2\text{mm} + 2\text{ppm} \times D)$ m.s.e. |
| GTS-239N           | : $\pm(3\text{mm} + 3\text{ppm} \times D)$ m.s.e. |
|                    | D:Measuring distance (mm)                         |

Least Count in Measurement

|                           |                                          |
|---------------------------|------------------------------------------|
| Fine measurement mode     | : 1mm (0.005ft.) / 0.2mm (0.001ft.)      |
| Coarse measurement mode   | : 10mm (0.02ft.) / 1mm (0.005ft.)        |
| Tracking measurement mode | : 10mm (0.02ft.)                         |
| Measurement Display       | : 12 digits : max. display 99999999.9999 |

Measurement Time

|                                                                               |       |                            |
|-------------------------------------------------------------------------------|-------|----------------------------|
| Fine measurement mode                                                         | : 1mm | : 1.2sec. (Initial 4 sec.) |
|                                                                               | 0.2mm | : 2.8sec. (Initial 5 sec.) |
| Coarse measurement mode                                                       |       | : 0.7sec. (Initial 3 sec.) |
| Tracking measurement mode                                                     |       | : 0.4sec. (Initial 3 sec.) |
| (The initial time will be different by a condition and setting EDM off time.) |       |                            |

Atmospheric Correction Range : -999.9 ppm to +999.9 ppm , in 0.1 ppm increments

Prism Constant Correction Range : -99.9 mm to +99.9 mm , in 0.1 mm increments

Coefficient Factor : Meter / Feet

International feet 1meter = 3.28083989501 ft.

US SURVEY feet 1meter = 3.28083333333 ft.

**Electronic Angle Measurement**

|                                                  |                                     |
|--------------------------------------------------|-------------------------------------|
| Method                                           | : Absolute reading                  |
| Detecting system:                                |                                     |
| Horizontal angle                                 |                                     |
| GTS-233N/235N                                    | : 2 sides                           |
| GTS-236N/239N                                    | : 1 side                            |
| Vertical angle                                   | : 1 side                            |
| Minimum reading                                  |                                     |
| GTS-233N/235N/236N                               | : 5" / 1" (1mgon / 0.2mgon) reading |
| GTS-239N                                         | : 10" / 5" (2mgon / 1mgon) reading  |
| Accuracy(Standard deviation based on DIN 18723 ) |                                     |
| GTS-233N                                         | : 3"(1mgon )                        |
| GTS-235N                                         | : 5"(1.5mgon )                      |
| GTS-236N                                         | : 6"(1.8mgon )                      |
| GTS-239N                                         | : 9"(2.7mgon )                      |
| Measuring time                                   | : Less than 0.3 sec.                |
| Diameter of circle                               | : 71 mm                             |

**Tilt Correction (Automatic index)**

|                    |                                                 |
|--------------------|-------------------------------------------------|
| Tilt sensor        |                                                 |
| GTS-233N/235N/236N | : Automatic vertical and horizontal compensator |
| GTS-239N           | : Automatic vertical compensator                |
| Method             | : Liquid type                                   |
| Compensating Range | : $\pm 3'$                                      |
| Correction unit    | : 1" (0.1mgon)                                  |

**Others**

|                                   |                                                                                                     |
|-----------------------------------|-----------------------------------------------------------------------------------------------------|
| Instrument height                 | : 176mm (6.93in) Base unit detachable<br>(Height from the tribrach dish to the center of telescope) |
| Level sensitivity                 |                                                                                                     |
| Circular level                    | : 10'/2mm                                                                                           |
| Plate level                       |                                                                                                     |
| GTS-233N/235N                     | : 30"/2 mm                                                                                          |
| GTS-236N/239N                     | : 40"/2 mm                                                                                          |
| Optical Plummet Telescope         |                                                                                                     |
| Magnification                     | : 3×                                                                                                |
| Focusing range                    | : 0.5m to infinity                                                                                  |
| Image                             | : Erect                                                                                             |
| Field of view                     | : 5°( $\phi$ 114mm/1.3m)                                                                            |
| Dimension                         | : 336(H)×184(W)×172(L) mm<br>(13.2(H)×7.2(W)×6.9(L) in)                                             |
| Weight                            |                                                                                                     |
| Instrument                        |                                                                                                     |
| (with battery)                    | : 4.9kg ( 10.8 lbs)                                                                                 |
| (without battery)                 | : 4.6kg ( 10.1 lbs)                                                                                 |
| Plastic carrying case             | : 3.4kg ( 7.5 lbs)                                                                                  |
|                                   | (Weight of the carrying case may be slightly different due to specific market.)                     |
| Durability                        |                                                                                                     |
| Protection against water and dust | : IP66 (with BT-52QA)<br>(Based on the standard IEC60529)                                           |
| Ambient Temperature Range         | : -20°C to +50°C (-4°F to +122°F)                                                                   |

**Battery BT-52QA (This battery does not contain mercury.)**

|                                                                |                           |
|----------------------------------------------------------------|---------------------------|
| Out put voltage                                                | : 7.2 V                   |
| Capacity                                                       | : 2700mAh(Ni-MH)          |
| Maximum operating time (when fully recharged) at +20°C (+68°F) |                           |
| Including distance measurement                                 | : 10hours (12,000 points) |
| Angle measurement only                                         | : 45hours                 |
| Weight                                                         | : 0.3kg ( 0.7 lbs)        |

**Battery Charger BC-27BR / BC-27CR**

|                                    |                                        |
|------------------------------------|----------------------------------------|
| Input voltage                      | : AC 120V(BC-27BR)<br>AC 230V(BC-27CR) |
| Frequency                          | : 50/60Hz                              |
| Recharging time (at +20°C /+68°F)  |                                        |
| Battery BT-52QA                    | : 1.8 hours                            |
| Discharging time (at +20°C /+68°F) |                                        |
| Battery BT-52QA                    | : 8 hours (in case of full charge)     |
| Operating temperature              | : +10°C to +40°C ( +50°F to 104°F)     |
| Charging signal                    | : Red lamp illumination                |
| Refreshing signal                  | : Yellow lamp illumination             |
| Finishing signal                   | : Green lamp illumination              |
| Weight                             | : 0.5kg (1.1 lbs)                      |

- Battery using time will vary depending on environmental conditions and operations done with GTS-230N series.

# APPENDIX

## 1 Dual Axis Compensation

Inclination of the vertical axis with respect to true vertical will result in incorrectly measured horizontal angles. The extent of the error in horizontal angle measurement due to axis tilt depends on three factors :

- the amount of the tilt of axis
- the elevation of the target
- the horizontal angle between the direction of tilt of the vertical axis and the target.

These factors are related by the following formula :

$$Hz_{err} = V \cdot \sin \alpha \cdot \tan h$$

where  $v$  = tilt of axis in arcseconds

$\alpha$  = azimuth angle between vert. axis direction and target

$h$  = elevation of target

$Hz_{err}$  = error in horizontal angle

Example: When the vertical axis is tilted by 30 arcseconds, the target is 10° above the horizon and rotated 90 in azimuth from the direction of the vertical axis error.

$$Hz_{err} = 30'' \cdot \sin \alpha \cdot \tan 10^\circ$$

$$Hz_{err} = 30'' \cdot 1 \cdot 0.176326 = 5.29''$$

From the above example it can be seen that horizontal angle errors will increase with steeper vertical sights (tangent will increase as vertical angle increases) and will be at a maximum when the target is at right angles ( $\sin 90^\circ = 1$ ) to the direction of the vertical axis error. Errors will be at a minimum when the sights are nearly horizontal ( $h=0$ ,  $\tan 0=0$ ) and in the same direction as the vertical axis error ( $\alpha=0$ ,  $\sin 0=0$ ). Please refer to the table below to see the relationship between axis tilt ( $v$ ) and elevation ( $h$ ) and the error in horizontal angles which results from these factors.

| $v$ | $h$ 0° | 1°    | 5°    | 10°    | 30°    | 45° |
|-----|--------|-------|-------|--------|--------|-----|
| 0"  | 0"     | 0"    | 0"    | 0"     | 0"     | 0"  |
| 5"  | 0"     | 0.09" | 0.44" | 0.88"  | 2.89"  | 5"  |
| 10" | 0"     | 0.17" | 0.87" | 1.76"  | 5.77"  | 10" |
| 15" | 0"     | 0.26" | 1.31" | 2.64"  | 8.66"  | 15" |
| 30" | 0"     | 0.52" | 2.62" | 5.29"  | 17.32" | 30" |
| 1'  | 0"     | 1.05" | 5.25" | 10.58" | 34.64" | 1'  |



It is clear from the table that dual axis compensation has the most benefit when the elevation of the target is greater than  $30^\circ$  and the axis is tilted more than  $10''$ . The entries indicated in bold in the table show, in fact, that for many common surveying applications i.e. target elevation  $<30^\circ$  and axis error  $<10''$ , virtually no correction would be required. Dual axis compensation is especially suited then for applications where the sights are very steep.

Even though the compensators can correct horizontal angles for vertical axis errors, ***it is still important to use care in setting up the instrument.***

Centering error, for instance, cannot be corrected by the compensators. If the vertical axis is tilted by  $1'$  with the instrument 1.4meters above the ground, a centering error of approx. 0.4mm will result. The maximum effect of this error at 10m is about  $8''$  of horizontal angle error.

In order to maintain the increased accuracy possible through dual axis compensation, it is necessary to keep the compensators in proper adjustment. The compensators must agree with the actual level condition of the instrument. Through various environmental stresses, the agreement between the level condition sensed by the compensators and the true level condition of the instrument may be disturbed. In order to reestablish the correct relationship between the compensator and the true level condition of the instrument, it is necessary to carry out the vertical indexing procedure listed on chapter 17.3.6 "Adjustment of Vertical Angle 0 Datum". This adjustment will both reset the vertical index (cause a direct + indirect zenith reading to the same elevation to equal  $360^\circ$ ) and zero the level reference for the horizontal compensator. While correct vertical angles can be obtained by averaging direct and indirect reading even when the index is improperly adjusted, the same is not true for horizontal angles. Since the vertical axis error is fixed for a given setup, its effect cannot be removed by averaging two readings.

***For this reason, it is extremely important to maintain the vertical indexing adjustment to insure proper correction of the horizontal angles.***

## 2 Precaution when Charging or Storing Batteries

The capacity of battery will be affected and its service life shortened in any of the following cases while it is recharged, discharged or stored.

### 1) Recharging

Fig. 1 shows how ambient temperature at recharging is related to charging efficiency or as affecting discharge capacity. As seen from the figure, charging at normal temperature is best, and the efficiency decreases as the temperature rises. It is best, therefore, to always recharge the battery at normal temperature to obtain full use of battery capacity and enjoy maximum operation per charge. And the service life of your battery will be shortened if it is frequently overcharged or recharged at high temperature.

Note: 0.1C charge means that the battery is recharged with 0.1 -time current as against its capacity.

### 2) Discharge

Fig. 2 shows discharge temperature characteristics. Discharge characteristics at high temperature are the same as those at normal temperatures. The battery is likely to have reduced discharge capacity as well as lower discharged voltage when discharged at low temperature. And the service life of your battery will be shortened if it is greatly overcharged.

Note: 1C discharge means one with 1 -time current over battery capacity.

### 3) Storage

See Fig. 3 for how storing period at different temperature levels is related to the remaining capacity. The battery will lose its capacity as storage temperature rises and the storage period increases.

This does not mean, however, that the battery performance is damaged when the battery is stored. The battery, reduced in capacity, will be restored once it is recharged. Always recharge your battery before use. And recharge and discharge the battery 3 or 4 times to restore its capacity if it has been stored for a long period or at high temperature. Storing at high temperature can adversely affect the service life of your battery.

Your battery has been fully charged before leaving the factory, but its capacity may be affected considerably when it takes several months to reach you, if it is stored at high temperature area or passes through a high-temperature region. Then, the battery must be recharged and discharged 3~4 times to fully restore its capacity.

And the battery should always be stored at normal temperature or lower if it will not be used for any long period. This helps your battery have a longer service life.

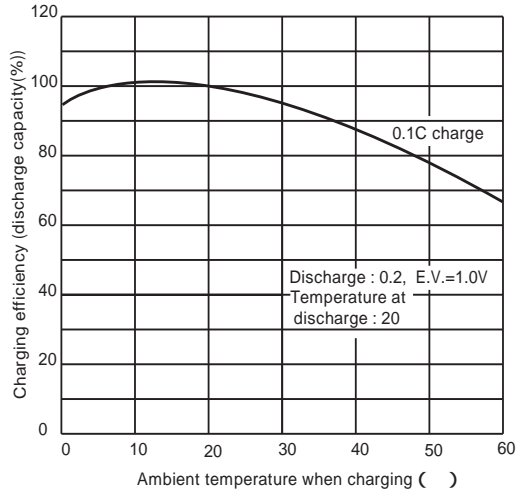

Fig.1 Recharging

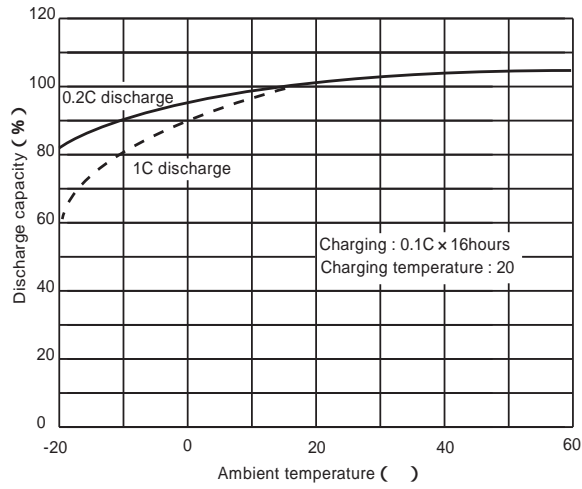

Fig. 2 Discharge

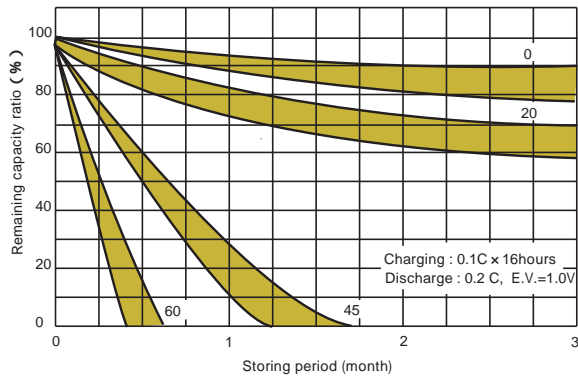

Fig. 3 Storage



**EMC NOTICE**

In industrial locations or in proximity to industrial power installations, this instrument might be affected by electromagnetic noise. Under such conditions, please test the instrument performance before use.

This is a CLASS A product. In a domestic environment this product may cause radio interference in which case the user may be required to take adequate measures.



## ELECTRONIC TOTAL STATION

# GTS-230Nseries

---

### TOPCON POSITIONING SYSTEMS, INC.

7400 National Drive, Livermore, CA 94551, U.S.A.  
Phone: 925-245-8300 Fax: 925-245-8599 [www.topcon.com](http://www.topcon.com)

### TOPCON CALIFORNIA

3380 Industrial Blvd, Suite 105, West Sacramento, CA 95691, U.S.A.  
Phone: 916-374-8575 Fax: 916-374-8329

### TOPCON EUROPE B.V.

Essebaan 11, 2908 LJ Capelle a/d IJssel, The Netherlands.  
Phone: 010-4585077 Fax: 010-4585045 [www.topconeurope.com](http://www.topconeurope.com)

### IRELAND OFFICE

Unit 69 Western Parkway Business Center  
Lower Ballymount Road, Dublin 12, Ireland  
Phone: 01460-0021 Fax: 01460-0129

### TOPCON DEUTSCHLAND G.m.b.H.

Giesslerallee 31, 47877 Willich, GERMANY  
Phone: 02154-885-100 Fax: 02154-885-111 [info@topcon.de](mailto:info@topcon.de)  
[www.topcon.de](http://www.topcon.de)

### TOPCON S.A.R.L.

89, Rue de Paris, 92585 Clichy, Cedex, France.  
Phone: 33-1-41069490 Fax: 33-1-47390251 [topcon@topcon.fr](mailto:topcon@topcon.fr)

### TOPCON ESPAÑA S.A.

Frederic Mompou 5, ED. Euro 3, 08960, Sant Just Desvern, Barcelona, Spain.  
Phone: 93-473-4057 Fax: 93-473-3932 [www.topconesp.com](http://www.topconesp.com)

### TOPCON SCANDINAVIA A. B.

Neongatan 2 S-43151 Mölndal, SWEDEN  
Phone: 031-7109200 Fax: 031-7109249

### TOPCON (GREAT BRITAIN)LTD.

Topcon House Kennet Side, Bone Lane, Newbury, Berkshire RG14 5PX U.K.  
Phone: 44-1635-551120 Fax: 44-1635-551170  
[survey.sales@topcon.co.uk](mailto:survey.sales@topcon.co.uk) [laser.sales@topcon.co.uk](mailto:laser.sales@topcon.co.uk)

### TOPCON SOUTH ASIA PTE. LTD.

Blk 192 Pandan Loop, #07-01 Pantech Industrial Complex, Singapore 128381  
Phone: 62780222 Fax: 62733540 [www.topcon.com.sg](http://www.topcon.com.sg)

### TOPCON AUSTRALIA PTY. LTD.

Unit 18, 4 Avenue of Americas Newington NSW 2127, Australia  
Phone: 02-8748-8777 Fax: 02-9647-2926 [www.topcon.com.au](http://www.topcon.com.au)

### TOPCON INSTRUMENTS (THAILAND) CO., LTD.

77/162 Sinn Sathorn Tower, 37th Fl.,  
Krungthongburi Rd., Klongtong Sai, Klongsarn, Bangkok 10600 Thailand.  
Phone: 02-440-1152-7 Fax: 02-440-1158

### TOPCON INSTRUMENTS (MALAYSIA) SDN. BHD.

Excella Business Park Block C, Ground & 1st Floor, Jalan Ampang Putra,  
Taman Ampang Hilir, 55100 Kuala Lumpur, MALAYSIA  
Phone: 03-42701068 Fax: 03-42704508

### TOPCON KOREA CORPORATION

2F Yooseoung Bldg., 1595-3, Seocho-Dong, Seocho-gu, Seoul, 137-876, Korea.  
Phone: 82-2-2055-0321 Fax: 82-2-2055-0319 [www.topcon.co.kr](http://www.topcon.co.kr)

### TOPCON OPTICAL (H.K.) LIMITED

2-4/F Meeco Industrial Bldg., No. 53-55 Au Pui Wan Street, Fo Tan Road,  
Shatin, N.T., Hong Kong  
Phone: 2690-1328 Fax: 2690-2221 [www.topcon.com.hk](http://www.topcon.com.hk)

### TOPCON CORPORATION BEIJING OFFICE

Building A No.9, Kangding Street  
Beijing Economic Technological Development Area, Beijing, China 100176  
Phone: 10-6780-2799 Fax: 10-6780-2790

### TOPCON CORPORATION BEIRUT OFFICE

P. O. BOX 70-1002 Antelias, BEIRUT-LEBANON.  
Phone: 961-4-523525/961-4-523526 Fax: 961-4-521119

### TOPCON CORPORATION DUBAI OFFICE

C/O Atlas Medical FZCO., P. O. Box 54304, C-25, Dubai Airport Free Zone, UAE  
Phone: 971-4-2995900 Fax: 971-4-2995901

---

## TOPCON CORPORATION

75-1 Hasunuma-cho, Itabashi-ku, Tokyo 174-8580, Japan  
Phone: 3-3558-2520 Fax: 3-3960-4214 [www.topcon.co.jp](http://www.topcon.co.jp)

GTS-230N 64536 91130 [ROAD]